

**3GPP TSG-N WG2
Phoenix, Arizona, USA
15-19 November 1999**

Tdoc 3GPP N2-99J85

Liaison Statement

To: TSG-CN

Copy To: TSG-SA, TSG-SA1 and TSG-SA2

Source: TSG-CN2

Work Item: CAMEL Control of VoIP Services FTR

TSG-CN2 has completed work on a final draft of the Feasibility Technical Report (FTR) for the 'CAMEL Control of Voice over IP (VoIP) Services' work item. The draft FTR is included as an attachment to this LS. The overall conclusion is that CAMEL control of VoIP services is feasible using either H.323 or SIP.

TSG-CN delegates are asked to approve the FTR. Assuming it is approved then work in TSG-CN2 on this work item is complete.

TSG-CN is also asked to allocate a document number for this FTR.

This LS is also copied to TSG-SA, TSG-SA1 and TSG-SA2 for information, and for possible inclusion of the CAMEL Control of VoIP Services capability in UMTS Phase 2 architectures and in the Stage 1 requirements for the next phase of CAMEL (Release 2000, CAMEL Phase 4).

3G TR ab.cde Vx.x.x (1999-04)

Technical Report

**3rd Generation Partnership Project;
Technical Specification Group Core Network;
Feasibility Technical Report – CAMEL Control of VoIP Services
(3G TR ab.cde version x.x.x)**



The present document has been developed within the 3rd Generation Partnership Project (3GPP™) and may be further elaborated for the purposes of 3GPP. The present document has not been subject to any approval process by the 3GPP Organisational Partners and shall not be implemented. This Specification is provided for future development work within 3GPP only. The Organisational Partners accept no liability for any use of this Specification. Specifications and reports for implementation of the 3GPP™ system should be obtained via the 3GPP Organisational Partners' Publications Offices.

Reference

DTS/TSG<name abbrev>-0<WG
no><spec no> U

Keywords

<keyword[, keyword]>

3GPP

Postal address

3GPP support office address

650 Route des Lucioles - Sophia
Antipolis

Valbonne - FRANCE

Tel.: +33 4 92 94 42 00 Fax: +33
4 93 65 47 16

Internet

<http://www.3gpp.org>

Contents

Intellectual Property Rights	6
Forward	6
1 Scope.....	7
2 References.....	7
3 Introduction.....	8
4 Definitions and Abbreviations	8
5 Proposition	9
5.1 Relationship with Architecture work in S2.....	10
6 Service Requirements	11
6.1 Basic Services.....	11
6.2 Supplementary Services	11
6.3 Operator Specific Services	11
6.4 Other Services	11
7 H.323 Solution	12
7.1 Description	12
7.2 Architecture	14
7.2.1 Introduction.....	14
7.2.2 Assumptions.....	15
7.2.3 Functional Architecture.....	15
7.3 Message Flows	16
7.3.1 Registration.....	16
7.3.2 MO call requiring CAMEL interaction.....	17
7.3.3 MT call requiring CAMEL interaction	18
7.4 State Models	19
7.4.1 H.323 and CAMEL O-BCSM.....	19
7.4.2 Successful call establishment.....	19
7.4.3 Unsuccessful call establishment due to gatekeeper admission reject.....	20
7.4.4 Unsuccessful call establishment due to refusal by destination party.....	21
7.4.5 H.323 and CAMEL T-BCSM	22
7.4.6 Successful MT call delivery.....	22
7.4.7 Unsuccessful MT call delivery.....	23
7.5 CAMEL Integration.....	24
7.5.1 Impact on H.323 Standards.....	24
7.5.2 Impact on CAMEL and other UMTS Standards	24
7.6 Service Impacts	24
7.7 Multimedia Evolution.....	25
7.8 Advantages	25
7.9 Disadvantages.....	25
8 SIP Solution	25
8.1 Description	25
8.2 Architecture	28
8.2.1 Introduction.....	28
8.2.2 Functional Architecture.....	28
8.2.3 Basic concept of the proposal	29
8.2.4 Assumptions.....	29
8.3 Message Flows	30
8.3.1 Proposed Registration process	30
8.3.2 Mobile Originating Call with CAMEL interaction	31
8.3.3 Mobile Terminating Call with CAMEL interaction.....	32
8.4 State Models	33

8.4.1	Mapping SIP message to CAMEL Basic Call State Models.....	33
8.4.2	Mapping to Originating BCSM for MO calls	33
8.4.3	Terminating BCSM for MT Calls	34
8.4.4	Unsuccessful MT Call Delivery.....	35
8.5	CAMEL Integration.....	36
8.5.1	Impact on SIP Standards.....	36
8.5.2	Impact on CAMEL and other UMTS Standards.....	36
8.6	Service Impacts	36
8.7	Multimedia Evolution.....	37
8.8	Advantages	37
8.9	Disadvantages.....	37
9	Work in other Standards Groups	37
9.1	3GPP.....	37
9.1.1	System Architecture Working Group 2 (S2).....	37
9.2	ETSI	38
9.2.1	TIPHON.....	38
9.2.2	SPAN3	38
9.3	IETF	38
9.4	ITU-T	39
9.4.1	SG11	39
9.4.2	SG16.....	39
10	Questions & Answers	40
11	Conclusions & Recommendations.....	40

Intellectual Property Rights

Forward

This Technical Report has been produced by the 3GPP.

The contents of the present document are subject to continuing work within the TSG and may change following formal TSG approval. Should the TSG modify the contents of this TS, it will be re-released by the TSG with an identifying change of release date and an increase in version number as follows:

Version 3.y.z

where:

- x the first digit:
 - 1 presented to TSG for information;
 - 2 presented to TSG for approval;
 - 3 Indicates TSG approved document under change control.
- y the second digit is incremented for all changes of substance, i.e. technical enhancements, corrections, updates, etc.
- z the third digit is incremented when editorial only changes have been incorporated in the specification;

1 Scope

The purpose of this Technical Report is to study the feasibility of a core network CAMEL server controlling voice services carried by VoIP within a GPRS PDP Context using:

- 1) An architecture based on ITU-T, H.323 family of recommendations.
- 2) An architecture based on IETF SIP specifications.

2 References

The following documents contain provisions, which through reference in this text, constitute provisions of the present document.

- References are either specific (identified by date of publication, edition number, version number, etc.) or non-specific.
 - For a specific reference, subsequent revisions do not apply.
 - For a non-specific reference, the latest version applies.
 - A non-specific reference to an ETS shall also be taken to refer to later versions published as an EN with the same number.
-
- [1] IETF RFC 1889, A Transport Protocol for Real-Time Applications.
 - [2] ITU-T Q.931, Digital Subscriber Signalling System No. 1 (DSS 1) – ISDN User-Network Interface Layer 3 Specification For Basic Call Control.
 - [3] GSM 04.08
 - [4] IETF RFC 2543, SIP: Session Initiation Protocol.
 - [5] N2-99826, “Feasibility Technical Report on CAMEL control of VoIP Services”, 19th-23rd July 1999, Visby, Sweden.
 - [6] “Location of the SSF entity in GPRS network supporting real-time applications”, Contribution from Lucent Technologies circulated to supporters of CAMEL control over VOIP on 26th July 1999.
 - [7] S2-99528, “The inclusion of a ‘Service Switching Function’ in the reference multimedia architecture for the support IN based service features”, 26th – 20th July 1999, New Jersey, USA
 - [8] Tdoc65, “Comments to DTR 02004, concerning IP, fixed wireless and cellular mobile roaming scenarios and the conceptual IP cellular network model”, Motorola, ETSI TIPHON Tel Aviv 26-30th October 1998.
 - [9] TS 101 441 Vx.4.0 Draft A, GSM 03.78, CAMEL Phase 3, stage 2
 - [10] N2-99826, “Feasibility Technical Report on CAMEL control over VoIP Services”, 19th-23rd July 1999, Visby, Sweden.
 - [11] TS 101 441 Vx.4.0 Draft A, GSM 03.78, CAMEL Phase 3, stage 2.
 - [12] ETSI TIPHON 10, Temporary Document 65, Tel Aviv, 26-30 Oct.1998

3 Introduction

The GSM CAMEL feature for control of operator specific services when roaming has evolved over a number of years and work on the latest Phase (Phase 3) is planned for completion as part of Release '99. Work in other 3GPP groups, particularly S2, is focused on developing a reference architecture for an all IP PLMN. One of the many requirements for 3G is to support roaming between 2G and 3G networks. Another requirement is to support a minimum set of 2G standardised supplementary services for roamers, such as call forwarding. The all IP PLMN is based on an evolved GPRS that supports voice over IP (VoIP).

VoIP calls may be established between 3G terminals or between a 3G terminal and legacy network terminal, such as 2G mobile, ISDN or PSTN. In the IP world there are currently two solutions that support VoIP; the H.323 family of recommendations defined by the ITU, and the Session Initiation Protocol (SIP) defined by the Internet Engineering Task Force (IETF). This Technical Report introduces these solutions and examines the feasibility of CAMEL controlling VoIP services in an all IP network with a view to supporting some 2G Supplementary Services and operator specific services or similar. Thus it is envisaged that CAMEL service control may be employed across 2G and 3G networks providing consistent services when roaming.

The information in the report is introduced below:

Section 5: briefly describes the proposal and functional model.

Section 6: addresses services that may be employed across 2G and 3G.

Section 7: describes the H.323 solution, architecture, message flows, state models, impact on standards, impact on services, multimedia evolution, advantages and disadvantages.

Section 8: describes the SIP solution, message flows, state models, impact on standards, impact on services, multimedia evolution, advantages and disadvantages.

Section 9: introduces work in other standards groups covering similar or related issues.

Section 10: records questions and answers from CN2a meeting presentations of earlier drafts

Section 11: describes conclusions and recommendations.

4 Definitions and Abbreviations

BCSM	Basic Call State Model
CAMEL	Customised Application for Mobile networks Enhanced Logic
CAP	CAMEL Application Protocol
CSI	CAMEL Subscriber Information
GGSN	Gateway GPRS Support Node
GPRS	General Packet Radio Service
HLR	Home Location Register
IPSSF	Internet Protocol Service Switching Function
MAP	Mobile Application Part
MSC	Mobile Switching Centre
MO	Mobile Originating
MS	Mobile Station

MT	Mobile Terminating
O-CSI	Originating CSI
PDP	Packet Data Protocol
SGSN	Serving GPRS Support Node
SIP	Session Initiation Protocol
SS-CSI	Supplementary Service CSI
T-CSI	Terminating CSI
VLR	Visitor Location Register

5 Proposition

An overall objective for this feasibility study is to demonstrate that CAMEL control of VoIP services in 3G networks can be readily specified and implemented by adapting standards and software used in 2G networks. This approach leads to services that function the same when a user roams between 2G and 3G networks, simplifies service evolution from 2G to 3G, and leads to more rapid implementation.

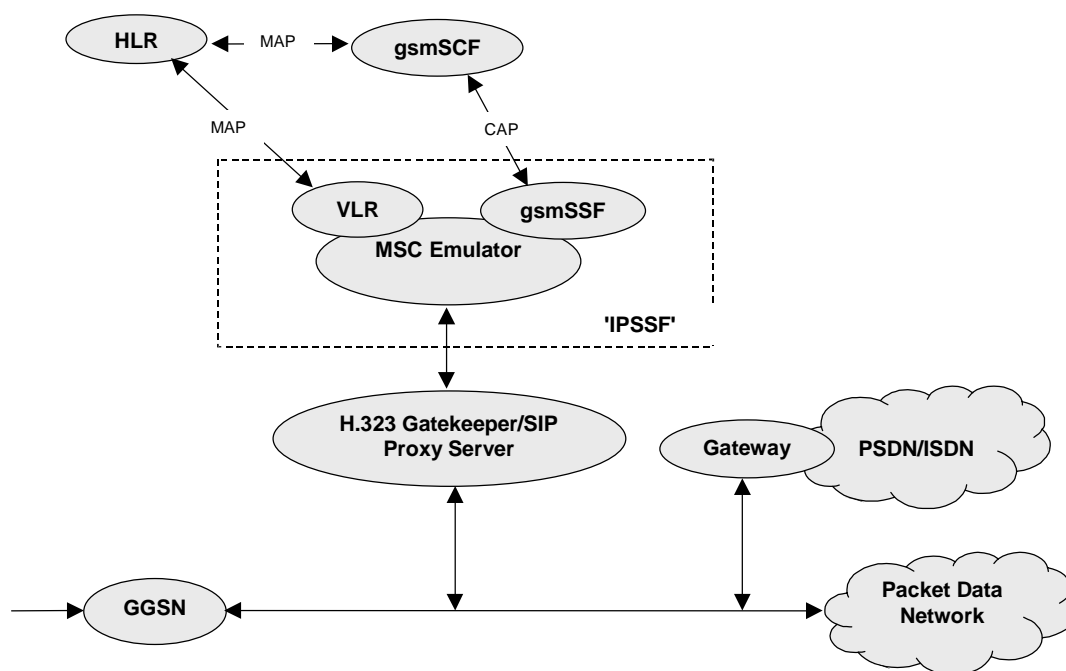

Figure 1: Functional Model for CAMEL Control of VoIP Services

Figure 1 illustrates the proposed functional model of the core network. It is derived from existing CAMEL specifications and 3GPP 23.121. In the latter technical specification, the Gatekeeper/SIP Proxy Server has been placed on the Gi interface to allow the Internet call control signalling to be transparent to the GPRS nodes, (SGSN and GGSN). Furthermore, if the signalling were to be non-transparent, and the SGSN were to handle the VoIP call control, the existing GPRS procedures, including the current CAMEL Phase 3 work would require changes. The reason is that if a subscriber roams outside the area served by the SGSN, the relationship between the *gsmSCF* and the SGSN in the old location is terminated and a new dialogue between the SGSN in the new location area and the

gsmSCF is established. Such an approach would not allow existing CAMEL services to be re-used without substantial changes, unless techniques such as anchoring original SGSN are introduced.

The functions represented in the model are:

HLR: Release '99 or later HLR

gsmSCF: Release '99 or later CAMEL Service Control Function (gsmSCF)

gsmSSF: Release '99 or later Service Switching Function

MSC Emulator and VLR: Modified Release '99 GMSC, VMSC and VLR functions. Many processes, such as call control, database and billing are retained or enhanced. Circuit switching and ancillary processes are removed. H.323 or SIP server inter-working functions are added. This combination of functionality is referred to in this report as the 'IPSSF'.

The interface between the H.323 Gatekeeper/SIP Server and the 'IPSSF' call control processes must:

- a) Carry sufficient call data for the gsmSSF to function correctly and to deliver the necessary information to the gsmSCF so that service logic decisions can be made.
- b) Allow the gsmSCF (in combination with gsmSSF and MSC Emulator) to control VoIP calls (e.g. change 'B' party address) and manipulate call information (such as presentation number) similar to a GSM Release '99 GMSC or VMSC.

H.323 Gatekeeper/SIP Proxy Server: – Either a H.323 Gatekeeper or a SIP Proxy server.

Gateway: - Provides interworking between packet network and external circuit switched networks such as PSTN or ISDN.

GGSN: – Release '99 or later Gateway GPRS Support Node

Notes:

Mobile Terminated (MT) Speech Calls: MT VoIP call states are modelled using a CAMEL Phase 3 or later T_BCSM as used for circuit switched MT calls.

Mobile Originated (MO) Speech Calls: MO VoIP call states are modelled using a CAMEL Phase 3 or later O_BCSM as for circuit switched MO calls.

Physical Location: The H.323 Gatekeeper/SIP Server and 'IPSSF' may be located in a home network or a visited network as both MAP signalling and CAP signalling are standardised for international use.

Physical Realisation: From the control of VoIP viewpoint the IPSSF and the H.323 Gatekeeper/SIP Server may be combined in one network entity or may be separate in separate network entities. If they are separate, standardisation of the interface may be required.

IP PDU Routing: Routing of IP call control packets to/from the H.323 Gatekeeper/SIP Proxy Server is not fully addressed in this work. It is simply assumed that appropriate addressing and routing takes place.

5.1 Relationship with Architecture work in S2

Ongoing architecture work in S2 for 3G is documented in TS 23.121 and in the Technical Report on 'Architecture for an all IP network' (TR 23.922 V1.0.0). The work in this CAMEL control of VoIP services FTR is intended to aid/complement S2 work by analysing feasibility at a somewhat lower level of abstraction, focusing on functional/protocol capabilities. The IPSSF in the functional model described above may form part of a Service Capability Server (SCS) in the Multimedia architecture PS Domain' described in TS 23.121. Similarly, it may form part of the Call State Control Function (CSCF) described in the all IP TR. The exact mapping between the Functional Model used in this report and the architectures developed by S2 requires further study and is work probably most appropriate to S2.

6 Service Requirements

In 3GPP, SA1 has responsibility for the definition of service requirements. Requirements for Release '00 are at a very early stage of development. When considering feasibility it is very useful to have in mind the services that a 3G network may be required to support. This section lists many example 2G network voice services that may be required by 3G VoIP customers, including some new 3G network possibilities, such as 'high quality audio'. Other services are being considered but not included here because the focus of this report is mainly on how existing 2G services may be support on an IP only network. Many of the services listed below are not supported by H.323 or SIP. They may be supported in the future. Services that early implementations may be required to support are show in *italics*. Detailed study is necessary to identify the services that require CAMEL control as it may be possible to re-use the VLR and MSC Emulator capabilities for some services without the need for CAMEL control, such as Operator Determined Barring. Some services may be more appropriate to implementation in the Terminal not the network, such as Call Hold.

6.1 Basic Services

Example basic services that may require CAMEL control in a 3G network:

- *Speech*
- *Emergency calls*
- Low bit rate data
- Medium bit rate data
- High bit rate data
- High quality audio
- Low bandwidth video
- High bandwidth video

6.2 Supplementary Services

Example 2G supplementary services that may require CAMEL control in a 3G network:

- *Operator determined barring*
- *User defined barring*
- *Call screening*
- *Call deflection*
- *Call forwarding unconditional*
- *Call forwarding on busy, no reply and not reachable*
- *Call waiting*
- *Call hold*
- *Call transfer*
- *Calling number identification presentation/restriction*
- *Connected number identification presentation/restriction*
- *Multiple Subscriber Profile*
- *Multi-party*
- *Call Completion Services (e.g. CCBS)*
- *Closed user group*
- *Advise of charge*
- *Calling name presentation*

6.3 Operator Specific Services

Example 2G operator specific services that may require CAMEL control in a 3G network:

- *Short number dialling*
- *Prepay*
- *VPN*

6.4 Other Services

Example services not listed in the 'Basic Services', 'Supplementary Services' or 'Operator Specific Services' categories that may require CAMEL control in a 3G network:

- *Lawful interception*
- *Voice group-call service*
- *Voice broadcast service*
- *ASCI*
- *MExE*
- *Location Services*

- SMS
- Fax
- *SoLSA*

7 H.323 Solution

7.1 Description

ITU-T defines a family of recommendations known as H.323 for multimedia communications over packet based networks. The majority of VoIP products available today support H.323.

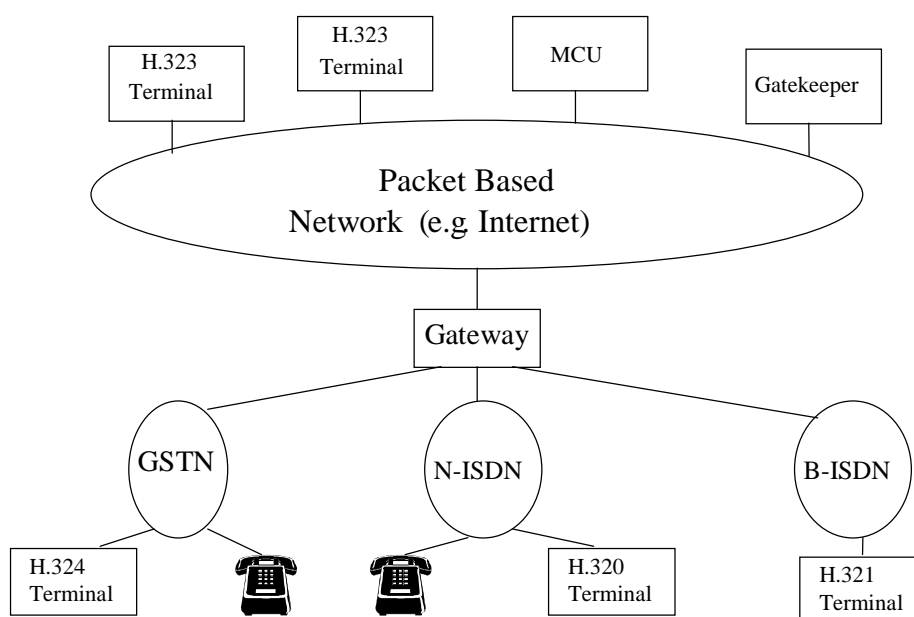

Figure 2: H.323 Environment

The H.323 environment is illustrated in Figure 2. A 'terminal' is a network endpoint that provides real-time, voice or multimedia communications with another Terminal or a Gateway. A Gateway is a network endpoint that provides the necessary translation services to allow H.323 terminals to communicate with terminals on other networks, such as the ISDN. A Gatekeeper is a network entity that provides address translation and access control. It may also provide bandwidth management. Gatekeepers are optional. A Multipoint Control Unit (MCU) is a network endpoint that provides the capability for VoIP conference calls. All terminals participating in a conference establish a connection with the MCU. It manages resources and negotiates between terminals to determine which video and audio codec to use.

Audio / Video Applications	Terminal Control and Management				Data applications
G.XXX H.XXX	RTCP	H.225.0 Terminal to Gatekeeper Signalling (RAS)	H.225.0 Call Signalling	H.245	T.124
RTP					T.125
Unreliable Transport (UDP)			Reliable Transport (TCP)		T.123
Network Layer (IP)					
Link Layer					
Physical Layer					

Figure 3: H.323 Protocol Architecture

Role	Protocol	Description
Audio/video applications	G.XXX	Audio codecs, e.g. G711, G722, G723, G728, G729
	H.XXX	Video codecs, e.g. H.261, H.263
	RTP	Real Time Protocol used to transport audio/video data payloads.
Terminal, control and management	H.225	Used for: <ul style="list-style-type: none"> • Call control based on Q.931 procedures. • Registration, Admission and Status (RAS) control procedures between terminal and Gatekeeper. • Packetization of control, audio, video, and data signals using Real time Control Protocol (RTCP) as well as transport and network layer protocols (e.g. UDP, TCP/IP)
	RTCP (Real Time Control Protocol)	RTP Control Packets
	H.245	Used for session negotiation & establishment. Based on Q.931.
Data applications	T.120 family	Used for multimedia data transfer.
Security	H.235	Defines security procedures for H.323 environments.
Supplementary services	H.450 family	Recommendations available now: <p>H450.1 - Generic protocol for supplementary services support H450.2 - Call Transfer H450.3 - Call Diversion H450.4 - Call Hold H450.5 - Call Park and Call Pick-up H450.6 - Call Waiting H450.7 - Message Waiting Indication</p> Recommendations for other Supplementary Services are planned.

Figure 4: H.323 Protocol Summary

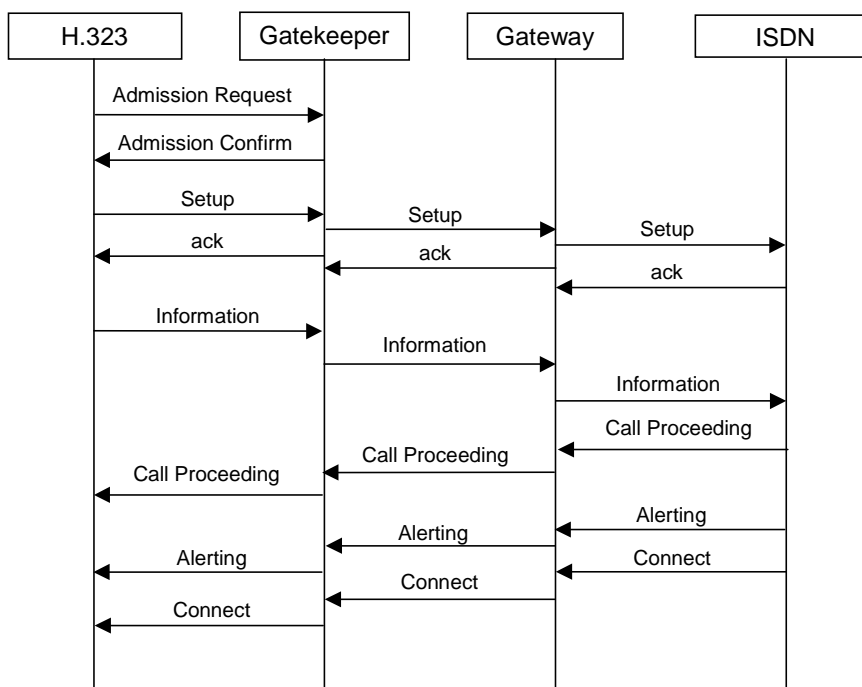

Figure 5: Simple Example H.225 Gatekeeper Routed Call Setup

Addressing: It is common for Internet addresses to be assigned dynamically which means that an IP addresses cannot be used to identify a user. One way of overcoming this problem is for users to register with a Gatekeeper . Once registered, other users can reach them by sending a location request message to the Gatekeeper. To accomplish roaming and IN service convergence a temporary ETSI TIPHON document reference[12] identifies a special type of Gatekeeper called a 'Mediation Gatekeeper' or 'MGK'. The user is assigned a unique ID (or 'alias') in the MGK, such as an MSISDN or an IP address. However, there are other methods that can be used. In this TR, H.323 roaming users are assumed to register with a Gatekeeper in a visited network and the alias is registered in the HLR.

H.225, GSM and IN Integration: H.225 messages are based on Q.931. GSM (04.08) call control processes are similar to Q.931. ITU-T IN Capability Sets (e.g. IN CS-1) are based around ISDN call control. Q.931 is the ISDN user-network interface layer 3 specification for basic call control. This common ancestry in ISDN and Q.931 especially, leads to a view that integration based on a common call control model may be feasible. H.323 supports an architecture where all call control signalling messages between terminals are routed via a Gatekeeper. A Gatekeeper seems to be an obvious choice when attempting to integrate H.225, GSM and IN (i.e. CAMEL).

7.2 Architecture

7.2.1 Introduction

This section of the report provides information flows that illustrate simple MO and MT calls with CAMEL interactions. It is based upon an architecture that proposed in references [6] and [7]. The objective is to provide further understanding of the proposed architecture and to further progress the work in the feasibility study.

7.2.2 Assumptions

- a. The call flows presented are based on using the ITU-T H.323 protocol between the Mobile Station (MS) and the Gatekeeper.
- b. The gatekeeper and the IPSSF have been co-located in order to avoid any showing information flows between the two entities. Standardisation of the information flows between these entities is for further study.
- c. The attach/detach and establishment of (MS initiated or network initiated) PDP context is based on existing GPRS procedures as defined in UMTS 24.008 and UMTS 29.060. No changes are assumed.
- d. The information flows make no consideration for interworking with other networks such as the PSTN/ISDN and no media gateways or signalling gateways are shown. This is considered to be outside the scope of the feasibility study.
- e. For this work, it is assumed that roaming users register with a gatekeeper in the visited network. It is acknowledged that there are several proposals in other standard bodies investigating other alternatives involving for example registration with home gatekeeper whilst roaming.
- f. The addressing mechanism used to identify called parties provides a means to identify the home GPRS network. An incoming call request can be forwarded to the mediation gatekeeper in the home network of the called user. The mediation gatekeeper can query the HLR to identify the gatekeeper that the called user is registered with. It is acknowledged that there are other alternatives being investigated by the various standards groups.

7.2.3 Functional Architecture

The proposed functional architecture is discussed in [6] and is shown in Figure 6. The main idea behind this functional architecture is to be able to reuse existing (circuit switched) CAMEL services for VoIP.

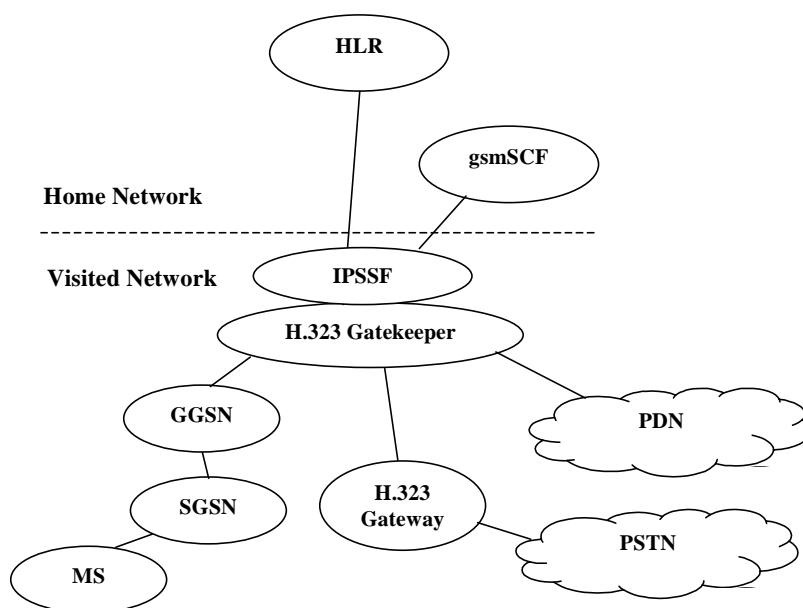

Figure 6: Proposed functional architecture

7.3 Message Flows

7.3.1 Registration

It is not within the scope of this feasibility study to investigate or select the registration and location update process that must exist within a multimedia service network. However this section outlines a possible registration process that allows CAMEL Subscriber Information (CSI) to be stored in the Gatekeeper/IPSSF. Two distinct levels of registration exist; one at the PDP transport capability (Attach/Detach and PDP context establishment) and another level at the VoIP/multimedia level. Within H.323, this latter registration takes place with a Gatekeeper and roaming users register with a gatekeeper in the visited network. Gatekeeper discovery can be achieved via H.323 gatekeeper discovery procedure or via the resolution of `ras://gk` via DNS.

Figure 7 outlines a proposed registration process. MS is a mobile station in a visited network.

- {1} The MS attaches to the network via existing GPRS procedures. This involves an attach request to the SGSN and a location update sequence from the SGSN to the HLR.
- {2} The MS activates a PDP context to establish an IP session with the gatekeeper.
- {3} The MS checks that it can register with that particular gatekeeper using a RAS *GatekeeperRQ* message. Assuming that the request is accepted, the gatekeeper confirms that registration can take place.
- {4} Upon confirmation that the MS is allowed to register with the gatekeeper, a RAS *Registration Request* is sent.
- {5} At this point, the gatekeeper sends a location update to the HLR in the user's home network to register the alias address. The HLR responds with an *InsertSubscriberData* message that contains the CAMEL subscription Information (CSI). At this stage it is assumed that the Originating CSI (O-CSI) and the Terminating CSI (T-CSI) is sent to the gatekeeper. Supplementary Service CSI (SS-CSI) applicability is for further study. The HLR keeps a record of the address of the gatekeeper that the MS is registered with.
- {6} Once the registration process is complete, the PDP session with the gatekeeper may be terminated.

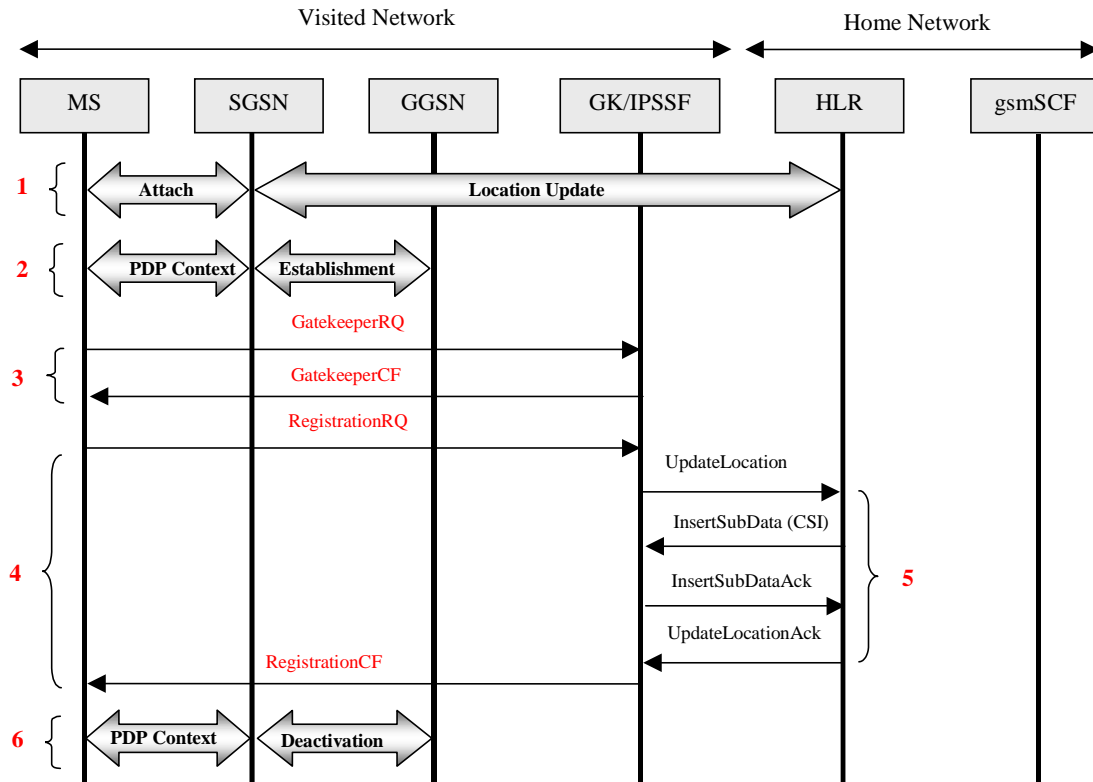

Figure 7: MS registration with gatekeeper

7.3.2 MO call requiring CAMEL interaction

The call flows for a mobile originated (MO) calls are shown in Figure 8 and are further explained below:

- {1} The MS wishes to place a VoIP call. A PDP context must be established to allow an IP session to be set up.
- {2} The MS checks that it is allowed to place a call via RAS *Admission Request* message.
- {3} If the MS is allowed to place the call (gatekeeper routed) an H.225 *Setup* message is sent to the gatekeeper.
- {4} When the *Setup* message is received at the gatekeeper, if the O-CSI for the calling user is present, it would be possible to analyse its contents and if necessary invoke the IPSSF. The IPSSF is now assumed capable of implementing the CAMEL O-BCSM. Later sections in this report cover the mapping of the O-BCSM points in call and H.323 call state model. The IPSSF starts a dialogue with the gsmSCF. The gsmSCF address and service key to invoke are obtained from the triggering criteria in the O-CSI.
- {5} The gsmSCF sends the instructions to the IPSSF according to the service logic invoked
- {6} The gatekeeper forwards the call according to the instructions received from the gsmSCF. H.225 *Setup* message is sent to the destination address.
- {7} Dialogue between the gsmSCF and the IPSSF may continue according to the service logic. The remainder of the information flows will vary according to the service logic and are not shown.

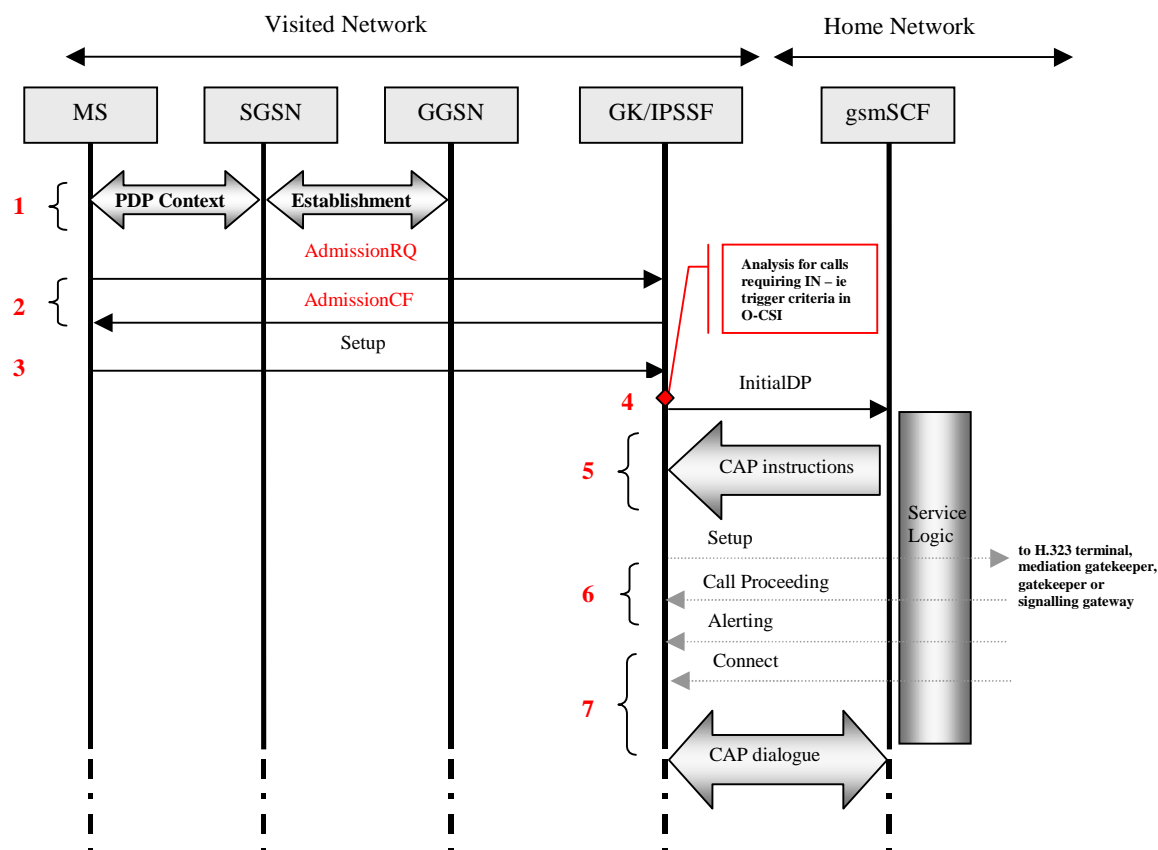

Figure 8: MO call with CAMEL interaction

7.3.3 MT call requiring CAMEL interaction

The call flows for mobile terminated (MT) calls are shown in Figure 9 and are further explained below:

- {1} An incoming H225 *Setup* message is received by the mediation gatekeeper in the home network of the called subscriber. (The incoming call could be from an other H.323 gatekeeper or H.323 signalling gateway representing a call originating from external networks such as the PSTN).
- {2} The mediation gatekeeper queries the HLR to discover the IP address of the gatekeeper that the called user is registered with. *SendRoutingInformation/Ack* messages can be used for this purpose.
- {3} The mediation gatekeeper forwards the call to the required gatekeeper by sending a *Setup* message.
- {4} The gatekeeper receives the H225 *Setup* message and checks the T-CSI of the called user to determine whether any CAMEL services should be invoked.
- {5} If analysis of the T-CSI shows that the triggering criteria are met, the IPSSF is invoked to create a T-BCSM and the IPSSF initiates a dialogue with the gsmSCF in the home network of the called user. Instructions are received from the gsmSCF on how the call is to proceed.
- {6} The gatekeeper will route the call according to the instructions received from the gsmSCF and will send an H225 *Setup* message to the destination party

- {7} Dialogue between the gsmSCF and the IPSSF may continue according to the service logic. The remainder of the information flows will vary according to the service logic and are not shown.

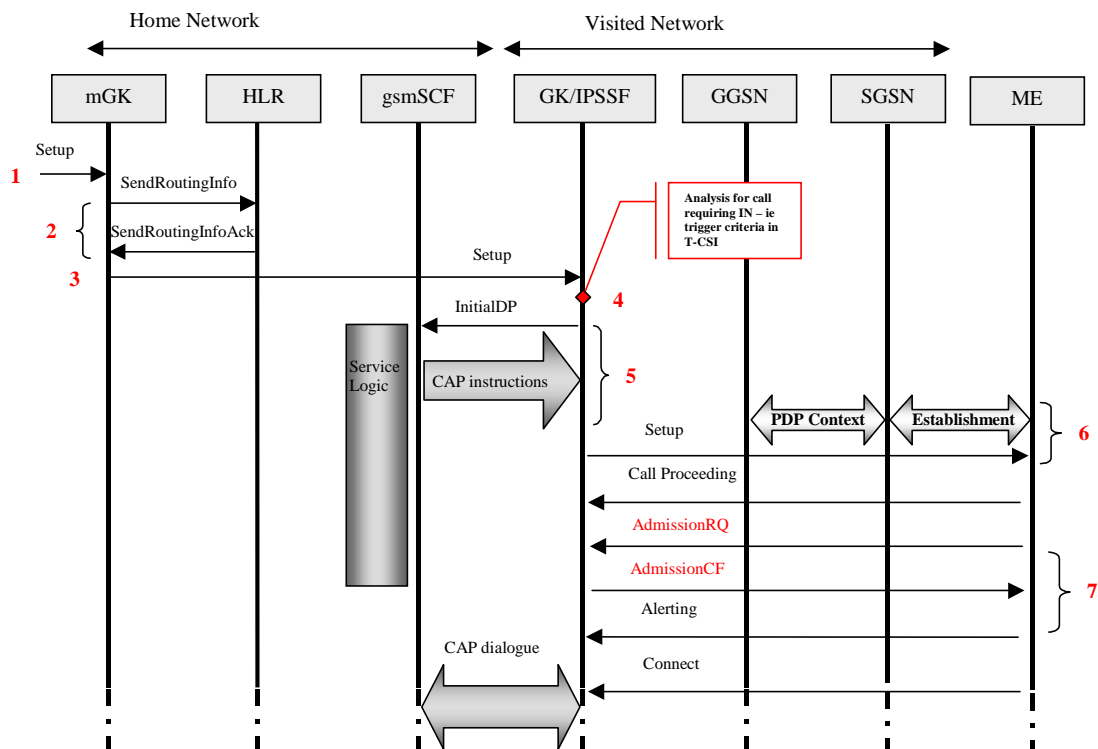

Figure 9: MT Call with CAMEL interaction

7.4 State Models

7.4.1 H.323 and CAMEL O-BCSM

Figures 10, 11 and 12 show the relationship between the H.323 protocol state model and the points in call (PICs) defined in the CAMEL phase 3 Originating Basic Call State Model (O-BCSM) for successful and unsuccessful call attempts. The O-BCSM represented is based on CAMEL phase 3 state models as described in reference [9]. For the sake of simplicity, the information flows between the GPRS network nodes (GGSN and SGSN), the gsmSCF and Gatekeeper/SSF are not shown in any of the Figures. The sequence of messages flows relating to the SGSN, GGSN and the gsmSCF are as covered in section 7.3.2 and Figure 8. An O-BCSM object can be created upon receipt of an H.225 Setup message and the analysis of the O-CSI.

The figures assume that the MS has previously registered with a gatekeeper in the network. The destination entity shown can be an other MS, gatekeeper, mediation gatekeeper or H.323 signalling gateway. As the call control protocol, H225 used in an H.323 environment is based on Q931, the mapping between the messages and the PICs are similar to existing GSM mechanisms.

7.4.2 Successful call establishment

Figure 10 shows the PICs and relationship to H.323 messages for a successful call establishment of MO call with CAMEL interaction.

- {1} The H.225 *Setup* message indicates that a dialled number is received from the MS and detects that an O-CSI exists for this subscriber.

- {2} Analysis of the O-CSI takes place and gsmSCF is invoked.
- {3} Instructions are received from the gsmSCF to route the call to the destination address.
- {4} Upon receipt of the *Connect* message from the called party, a transition to the PIC *O_Active* takes place. *O_Answer* DP can be reported.
- {5} Either called or calling party can release the call with a *ReleaseComplete* message, upon which a transition to the PIC *O_Null&Authorise_Origination_Attempt_Collect_Info* takes place and the DP *O_Disconnect* may be reported.

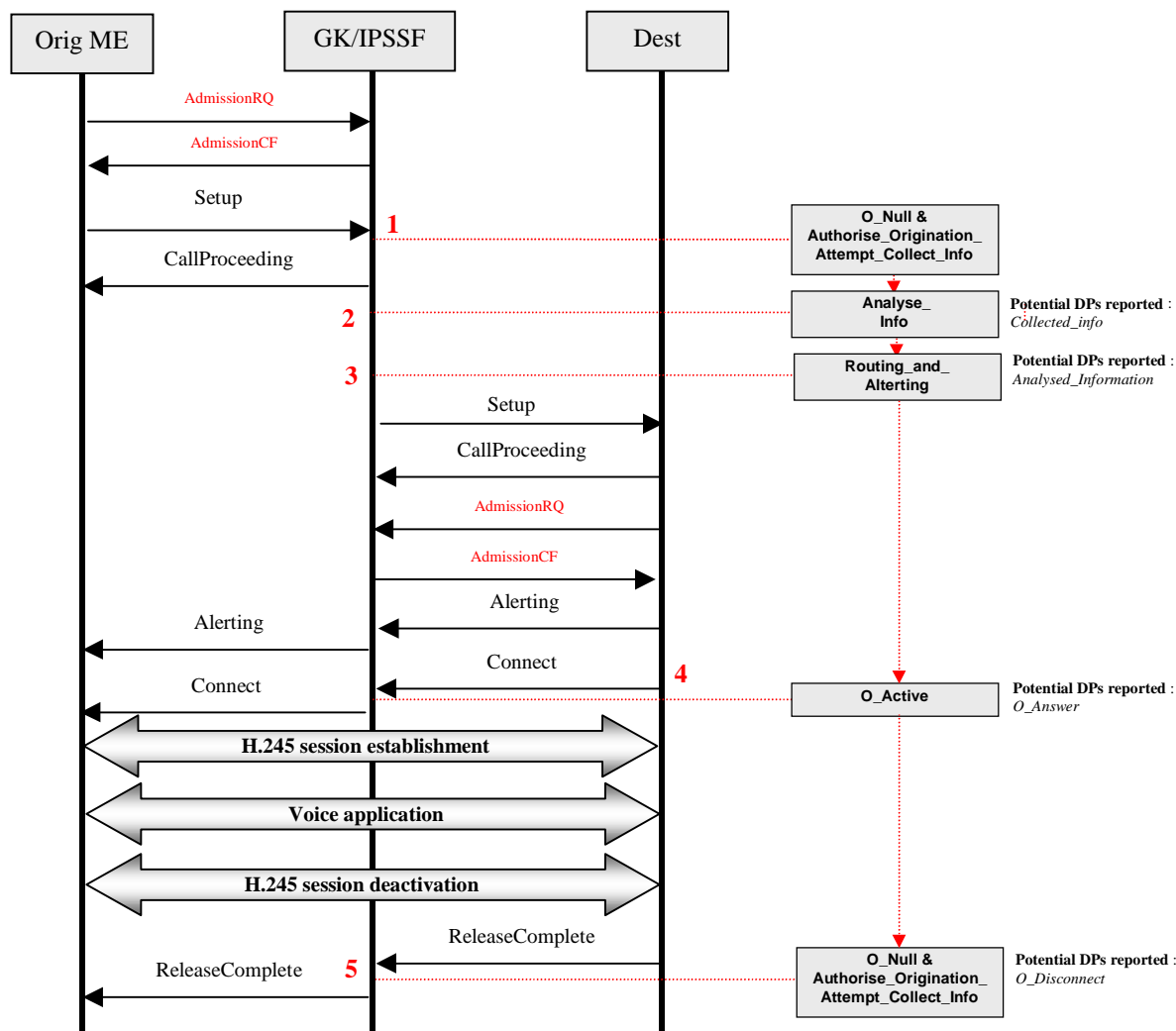

Figure 10: H.323 message flows and corresponding CAMEL O-BCSM for successful call establishment

7.4.3 Unsuccessful call establishment due to gatekeeper admission reject

Figure 11 shows the PICs and relationship to H.323 messages for the situation where the destination is refused permission to accept the incoming call by the gatekeeper. An *AdmissionReject* message may be sent by the gatekeeper to the destination is registered with for reasons specified in RAS procedures. In

order to keep the Figures relatively simple, the PICs O_Null&Authorise.. and Analyse_Info and corresponding message flows are not shown.

- {1} Instructions received from the gsmSCF on routing of the call and an H.225 *Setup* message is sent to the destination.
- {2} The destination is not given permission by the gatekeeper to accept the incoming call. A number of reasons could exist, such as insufficient bandwidth, permission expired etc. This information is carried in the rejection reason of the *AdmissionReject* and transported into the *ReleaseComplete* message back to the gatekeeper.
- {3} *ReleaseComplete* message arrives at gatekeeper indicating that the call could not be completed. DPs Route_Select_Failure or O_Routing_and_Alerting_Failure may be reported according to the rejection reason provided in the *ReleaseComplete* message.

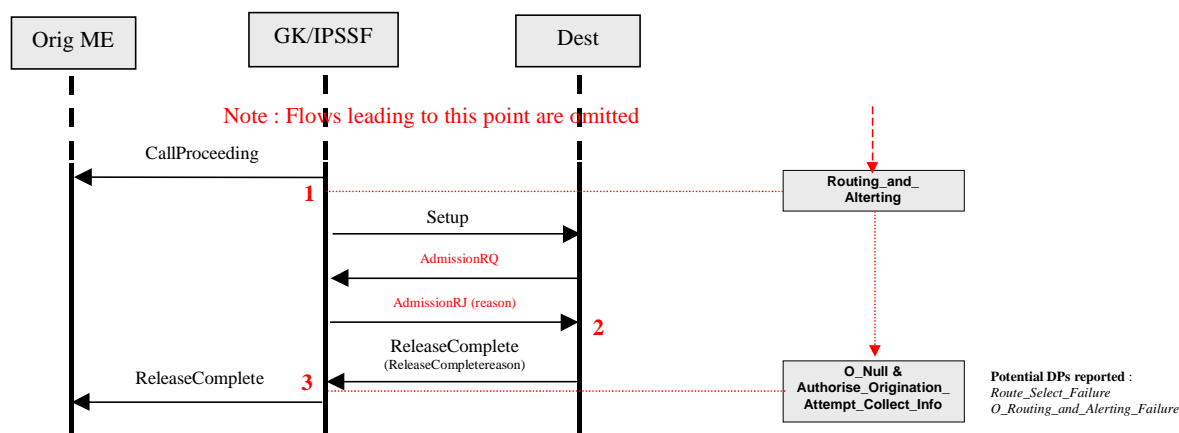

Figure 11: H.323 messages flows and corresponding CAMEL O-BCSM for the case where the destination is refused permission to accept the call by the gatekeeper

7.4.4 Unsuccessful call establishment due to refusal by destination party

Figure 12 shows the PICs and relationship to H.323 messages for the situation where the destination does not accept the incoming call request. Once again, in order to keep the Figures relatively simple, the PICs O_Null&Authorise.. and Analyse_Info and corresponding message flows are not shown.

- {1} Instructions received from the gsmSCF on routing of call and an H.225 *Setup* message is sent to the destination.
- {2} The gatekeeper receives a *ReleaseComplete* message with a release reason. Potentially, depending on the release reason, the DPs O_No_Answer, O_Busy, O_Abandon, O_Routing_and_Alerting_Failure or Route_Select_Failure may be reported.

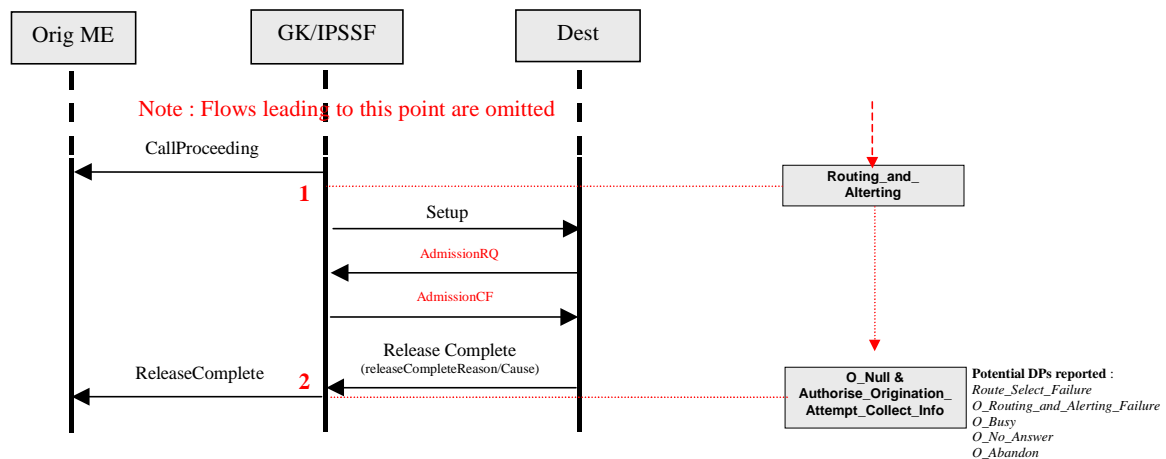

Figure 12: H.323 messages flows and corresponding CAMEL O-BCSM for the unsuccessful establishment (other than admission refusal)

7.4.5 H.323 and CAMEL T-BCSM

Figures 13 and 14 show the relationship between the H.323 protocol state model and the points in call (PICs) defined in the CAMEL phase 3 Terminating Basic Call State Model (T-BCSM) for successful and unsuccessful MT call attempts. The T-BCSM represented is based on CAMEL phase 3 state models as described in reference [9]. Once again, for the sake of simplicity, the information flows between the GPRS network nodes (GGSN and SGSN), the gsmSCF and Gatekeeper/SSF are not shown in any of the Figures. The sequence of messages flows relating to the SGSN, GGSN and the gsmSCF are as covered in section 7.3.3 and Figure 9. A T-BCSM object can be created upon receipt of an H.225 Setup message and the analysis of the T-CSI.

7.4.6 Successful MT call delivery

Figure 13 shows the PICS and relationship to the H.323 protocol state model for a successfully established MT call requiring CAMEL interaction.

- {1} The H.225 *Setup* message arrives at the gatekeeper the destination MS is register with. If a T-CSI exists for the subscriber, a T-BCSM instance is created.
- {2} Analysis of the T-CSI takes place and gsmSCF is invoked
- {3} Instructions from the gsmSCF are received and upon receipt of the *Connect* message from the called MS a transition to T_Answer takes place. The DP T_Answer may be reported.
- {4} Either calling or called party can release the call with a *ReleaseComplete* message, upon which a transition to PIC T_Null takes place with potentially the DP T_Disconnect being reported.

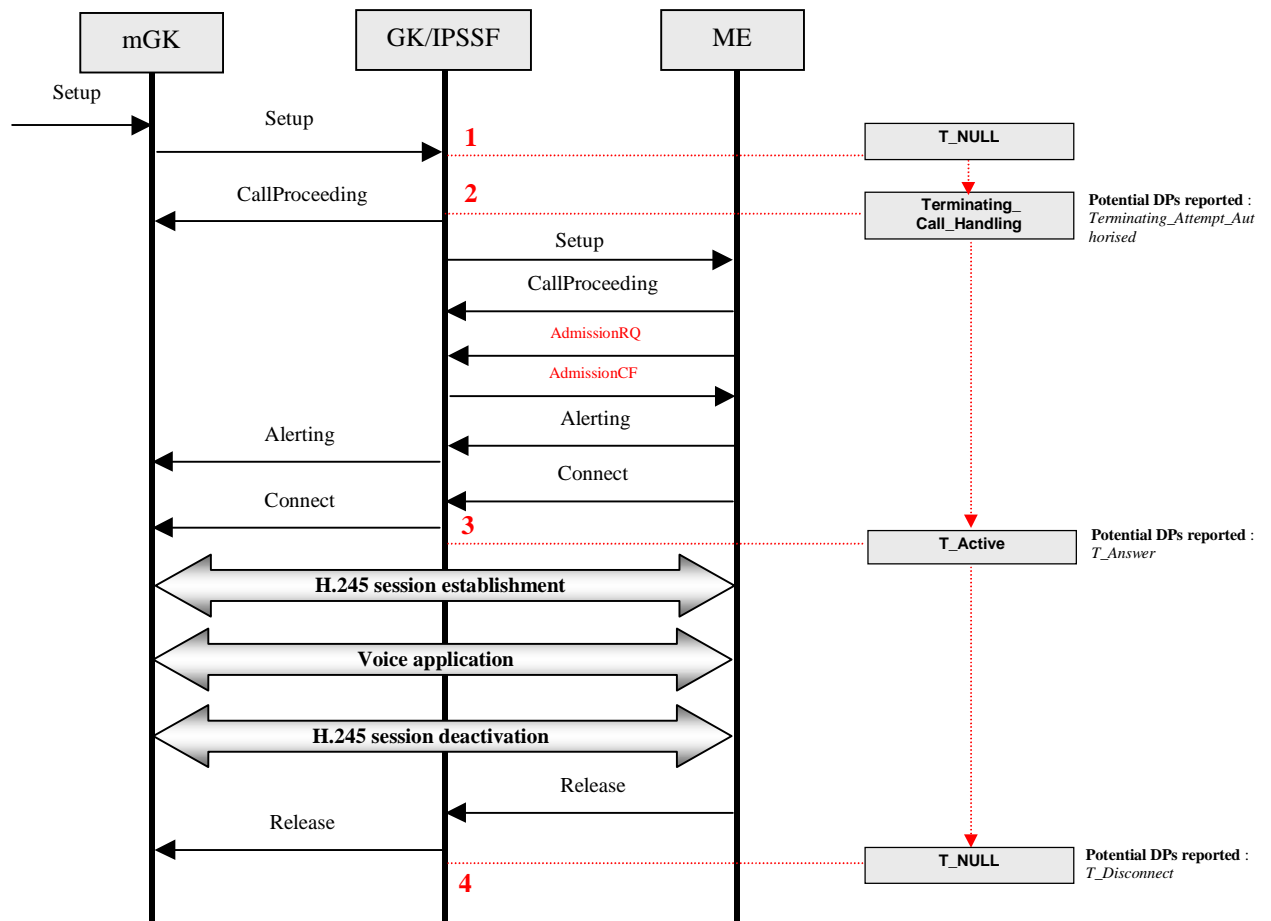

Figure 13: H.323 message flows and corresponding CAMEL T-BCSM for successful call establishment

7.4.7 Unsuccessful MT call delivery

Figure 14 shows the PICs and relationship to H.323 message for the situation where the terminating MS does not accept the incoming call.

- {1} The H.225 Setup message arrives at the gatekeeper the destination MS is register with. If a T-CSI exists for the subscriber, a T-BCSM instance is created.
- {2} Analysis of the T-CSI takes place and gsmSCF is invoked
- {3} The called party refuses to accept the call and sends a *ReleaseComplete* message to the gatekeeper. The *ReleaseComplete* message may contain release reason. Potentially, depending on the release reason, the DPs T_No_Answer, T_Busy, T_Abandon or T_call_handling_Failure may be reported.

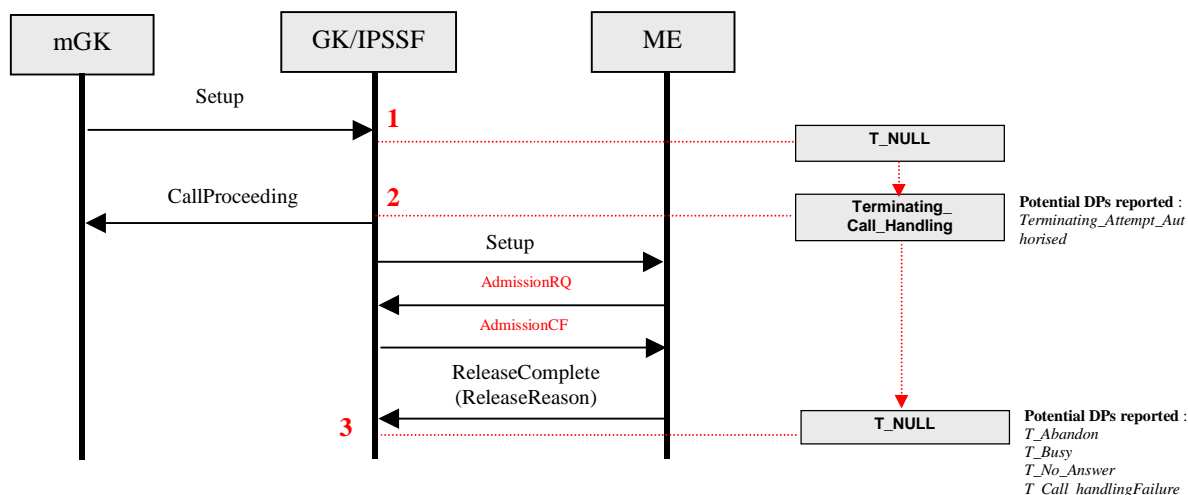

Figure 14: H.323 message flows and corresponding CAMEL T-BCSM for unsuccessful call establishment

7.5 CAMEL Integration

Integration of CAMEL functions with H.323 Gatekeeper functions may require enhancements to H.323 standards or CAMEL standards. Some initial work has been done to identify the standards that may need to be enhanced and to assess the extent of the changes required.

7.5.1 Impact on H.323 Standards

Section 7.4 describes and illustrates how H.225 messages may be mapped to O_BCSM and T_BCSM Detection Points (DPs) at the Gatekeeper/SSF. When studying the Figures it can be seen that some CAMEL Phase 3 DPs (such as O_Active) have good correspondence with H.225 messages at the Gatekeeper, while other DPs require more detailed analysis. At this level of analysis it seems likely that changes to H.323 may not be needed.

As the H.323 standards are already well established it seems likely that changes would be unwelcome in and it seems more likely that, if necessary, some reduction in CAMEL functionality may be a more acceptable compromise.

7.5.2 Impact on CAMEL and other UMTS Standards

It is likely the some functional modelling additions and some CAP message information element additions will be needed. It is also likely that some HLR/VLR data and MAP protocol additions may be needed. It is of course very difficult to assess and describe exactly how much effort and meeting time is required to effect these changes. In comparison to previous CAMEL work on Phase 1, Phase 2 and Phase 3, in the author's opinion the effort required is probably more than was necessary to complete GPRS inter-working in CAMEL Phase 3, but probably less than the work necessary to complete CAMEL Phase 1.

The major impact of these changes concerns documents 22.078, 23.018, 23.078, 29.078 and 29.002.

7.6 Service Impacts

The combination of CAMEL and H.323 (as described in this report) may support some GSM supplementary services, such as unconditional call forwarding (subject to some re-engineering) and perhaps most operator specific services (depends on the extent of any reduced functionality necessary for integration). Every service needs to be studied in detail to determine exactly what can be supported.

Interworking with H.323 based supplementary services is another aspect. Again every service needs to be studied in detail, however, it seems likely that a comparable level of inter-working may be possible to that achieved with a combination of an MSC and ISDN, i.e. low-level services like CLI probably are feasible but more complex services may not be feasible.

7.7 Multimedia Evolution

The proposal in this report is focused on voice not multimedia. Control of multimedia services requires further study. However, the proposal does not in any way preclude CAMEL evolution to control multimedia services supported by the H.323 family of recommendations. It is likely that further enhancements to the protocols and functions listed in section 7.5.2 (e.g.. MAP, CAP, HLR, VLR, CSE) may be necessary, depending on the nature of the multimedia service control required.

7.8 Advantages

The following advantages have been identified:

- Maximises the re-use of existing functional entities, protocols and services. Such reuse decreases the development and ownership costs allowing existing familiar 2G services to be provided to 3G subscribers at an early stage.
- Minimum changes to the CSE for the support of legacy services. There are several IN/CAMEL services already deployed such as PrePaid, VPN, Mobile Number Portability etc., which may be required in a voice over IP network.
- This approach is in line with the work currently underway in ETSI SPAN 3 (Services and Protocols), in particular a work item addressing IN support for voice over IP in the H.323 architecture and associated protocols in association with the TIPHON project. The study will investigate how an H.323 gatekeeper can act as a virtual Service Switching Point (SSP). It is worth noting that ETSI plan to harmonise the fixed line IN protocol (ETSI Core INAP CS3.1) and mobile equivalent (CAP Phase 3) into a common protocol targeted for ETSI Core INAP CS4.

7.9 Disadvantages

The following disadvantages have been identified:

- Introduces new functional entity 'IPSSF', which provides the necessary mapping between the Gatekeeper and the CSE. However, this functional entity is based on the functions already provided by a VMSC/GMSC, where already standardised process such as the gsmSSF can be reused.

The interface between the SCS/CSCF and the IPSSF requires further study.

8 SIP Solution

8.1 Description

The IETF Multiparty Multimedia Session Control (MMUSIC) working group specifies an IP telephony architecture (Figure 15). The architecture is seen as an alternative to ITU-T H.323 family of recommendations that is simpler to implement. It allows for the possibility of interworking with H.323 terminals. However, H.323 currently has the greatest industry backing.

The Session Description Protocol (SDP) can be likened to H.245 (channel open/close and terminal capability handling). Session descriptions have a list format containing information about the session

(see RFC 2327). The Session Initiation Protocol (SIP), reference [4], can be likened to H.225 (Registration, Admission, Status (RAS), and Q.931 messages). Message headers are in plain text and look similar to Email headers.

SIP uses a client server model similar to the Hypertext Transfer Protocol (HTTP) and many others (Figure 16 (a)). It is used in conjunction with other protocols such as SDP, RTP and RSVP. SIP can establish connections via TCP or UDP (Figure 16 (b)).

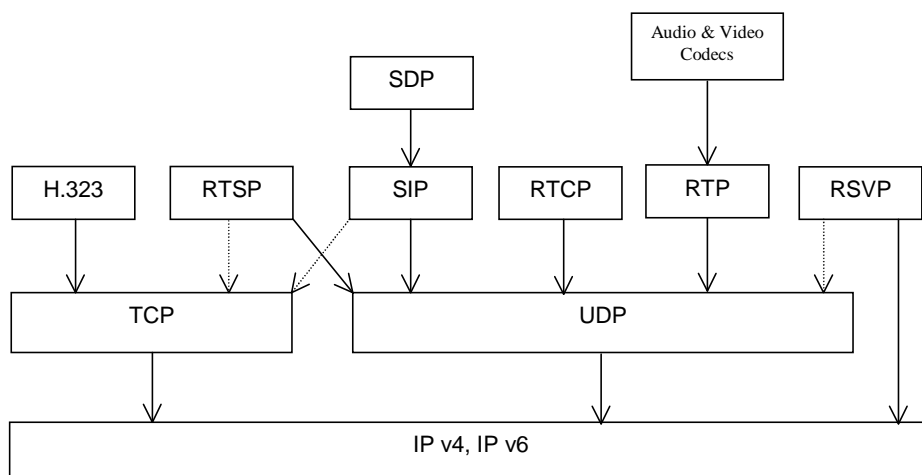

Figure 15: IETF IP Telephony Architecture

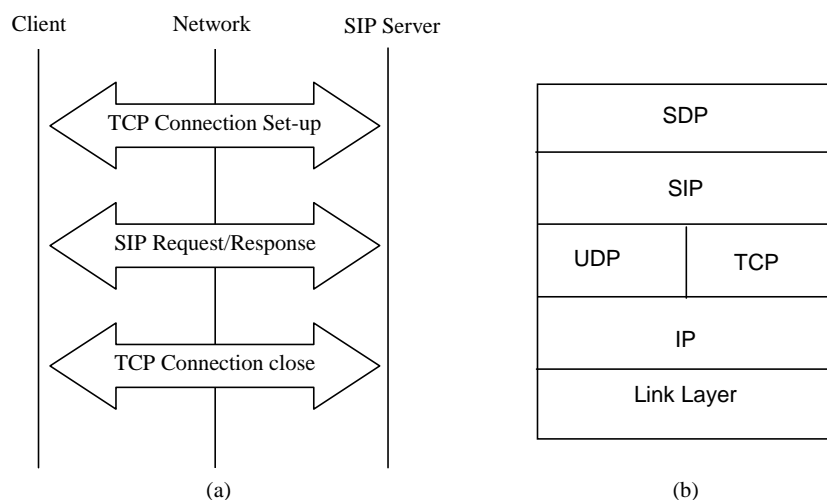

Figure 16: (a) Client/Server Model using TCP, (b) Protocol Stack using UDP/TCP

SIP Messages: To initiate a session a client sends an INVITE message to a server. An INVITE message typically contains a session description in SDP sufficient to establish communication. SIP Request and Response messages are listed below.

SIP Request Messages

- INVITE
- ACK
- BYE
- CANCEL
- OPTIONS

SIP Response Messages

- 1xx Informational
- 2xx Success
- 3xx Redirection
- 4xx Client Error
- 5xx Server Error

REGISTER

6xx Global Failure

- INVITE - Invites client or server to establish a session.
 ACK - Confirmation reception of a final response to an INVITE message.
 BYE - The sender wishes to close the session.
 CANCEL - Cancels pending requests.
 OPTIONS - Asks for information about capabilities before establishing a session.
 REGISTER - Informs a Location Server of the client's IP address.

SIP response messages use a 3 digit number, e.g. 1xx. The first digit defines the category. The next two digits allow up to 100 variations, e.g. 200 OK (successful invitation).

Session Establishment: Sessions may be established using direct point-to-point communication or by using a SIP Server for personal mobility. A SIP server may be a Redirection Server or a Proxy Server. To establish a session using a SIP server the originator sends an INVITE message to the server. The server communicates with a Location Server to retrieve the IP address of the terminating party. When a Redirection Server is employed (Figure 17) the IP address is passed to the originator. The originator sends a new INVITE message and a session is established with the terminating party. When a Proxy Server is employed (Figure 18) the address of the terminating party is not passed to the originator. A Session is established between the originator and terminating party via the Proxy Server. One or more intermediate Proxy Servers may take part in the session. It is envisaged that a Proxy Server may be a network entity where CAMEL service control could be applied. This possibility is investigated further in this report.

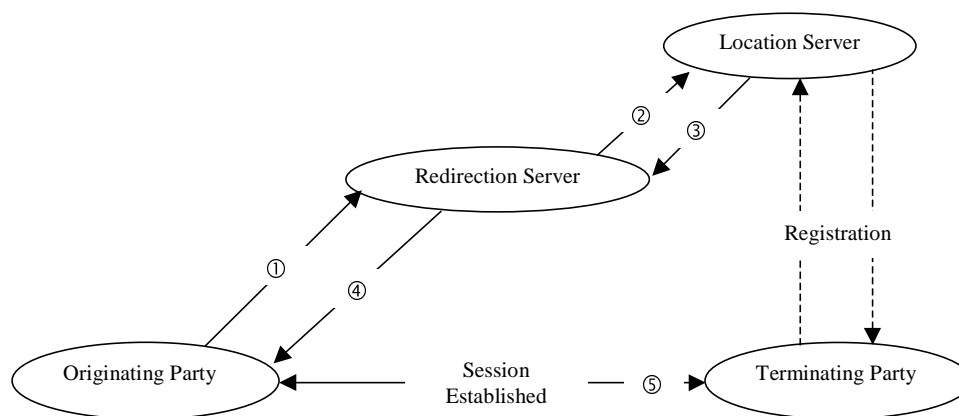

- ① Terminating Party IP address: dsmith@anynet.com
- ② Terminating Party IP address: dsmith
- ③ Terminating Party IP address: dsmith@temp.com
- ④ Terminating Party IP address: contact dsmith@temp.com
- ⑤ Terminating Party IP address: dsmith@temp.com

Figure 17: Session Establishment Using a Redirection Server

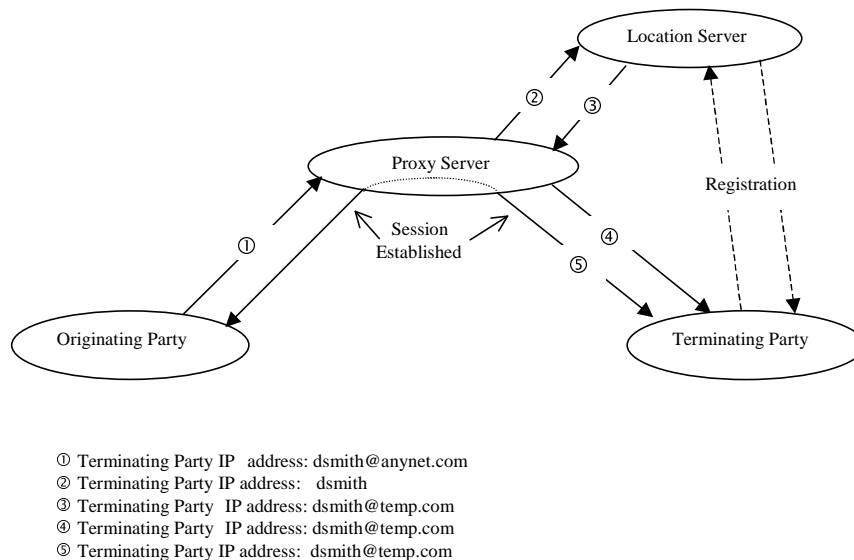

Figure 18: Session Establishment Using a Proxy Server

Interworking with H.323: RFC 2543 states (reference [4]) that SIP could be used to determine that a party can be reached via H.323, obtain the H.245 gateway and user address and then use H.225.0 to establish the call.

8.2 Architecture

8.2.1 Introduction

This section of the report provides information flows that illustrate the possible interaction of CAMEL and SIP. In particular it provides a proposal for the triggering of CAMEL services as well as a mapping between the CAMEL call states and the call states of the Session Initiation Protocol (SIP).

An overall objective for the feasibility study is to demonstrate that CAMEL control of VoIP services in 3G networks can be readily specified and implemented by adapting standards and software used in 2G networks. This approach leads to services that function the same when a user roams between 2G and 3G networks, simplifies service evolution from 2G to 3G, and leads to more rapid implementation. This section of the report investigates the possibility of CAMEL service control based on the SIP proxy Server approach, as described in companion contributions (or sections that will form part of the technical report). This means that a locally configured proxy server is required for outgoing calls that require legacy service support based on existing CAMEL services.

The section of the report is organised as follows: Section 8.2.2 outlines the proposed functional architecture for the support of CAMEL/SIP interaction. Section 8.2.3 briefly describes the concepts for IN service triggering based on CAMEL Subscription Information. Section 8.3.1 describes a registration process, section 8.3.2 deals with the detail of triggering services for Mobile Originated Calls, section 8.3.3 deals with the details for triggering Mobile Terminated calls. Section 8.4 describes the mapping of the SIP protocol state to the CAMEL basic call state model for the Originating and the Terminating sides.

8.2.2 Functional Architecture

The proposed functional architecture is derived from various companion contributions relating to the technical report. It is provided here for completeness. The concept of the 'IPSSF' is introduced which acts as an overlay between the IP telephony call control and the Intelligent Network layer provided by the CAMEL Service Environment (CSE) or the GSM Service Control Function (gsmSCF). This 'IPSSF' provides the necessary mapping between the SIP protocol state machine and the CAMEL

Basic Call State Model (BCSM). Figure 19 outlines the proposed functional architecture at the network level.

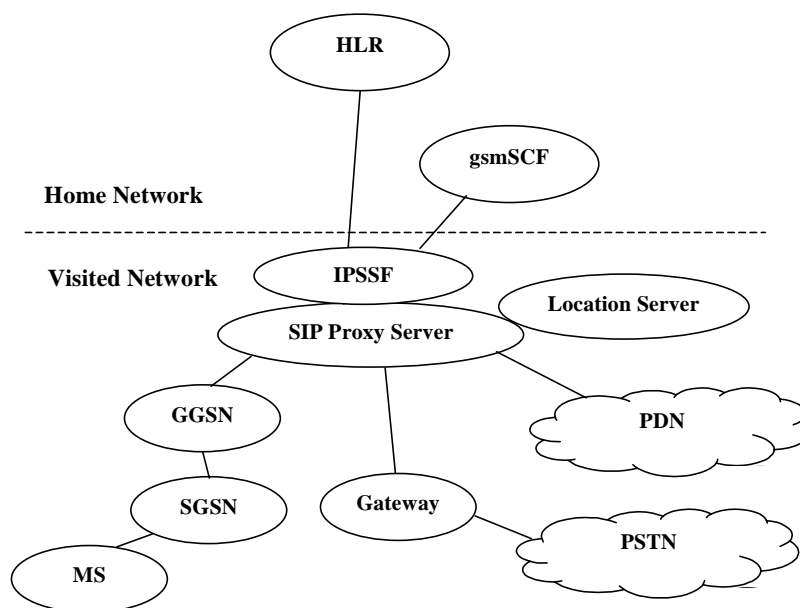

Figure 19: Proposed functional Architecture to support CAMEL control of VoIP based on SIP call control

8.2.3 Basic concept of the proposal

Subscribers may register in the visited SIP network allowing the subscriber to receive incoming calls. A subscriber may use the MSISDN as an additional identifier in the registration process. Upon registration with the server, the CAMEL subscription information for the subscriber is sent to the IPSSF by the HLR in the subscriber's home network. As incoming calls made to the subscriber terminate at the server the subscriber is registered with, the Terminating CAMEL Subscription Information (T-CSI) may be examined and if necessary the gsmSCF may be invoked on a per incoming call basis. Similarly, calls made by a subscriber already registered with a proxy server allow the Originating CAMEL (O-CSI) subscription information to be examined and potentially allow the gsmSCF to be invoked. Callers not registered will not have any O-CSI information in the proxy server they are using to place the call. The proposal here is as follows: when the initial call request message (or the *INVITE* method) is received by the SIP proxy server, the IPSSF/VLR establishes a dialogue with the HLR of the home subscribers network to allow the CAMEL subscription information to be sent. The O-CSI may then be examined and if necessary the gsmSCF may be invoked.

8.2.4 Assumptions

- a. All the call flows show that the SIP Proxy Server and the IPSSF have been co-located in order to avoid showing an information flows between the two entities. Standardisation of the messages for this interface is for further study.
- b. The attach/detach and establishment of the Packet Data Protocol (PDP) session are based on existing GPRS procedures found in UMTS 24.080 and UMTS 29.060.

- c. When a subscriber registers or places a call via a SIP Proxy server, the home network of the subscriber can be identified.
- d. A subscriber may use the MSISDN as an additional identifier in the registration process.
- e. Originating and terminating SIP Proxy servers must operate in a call-state aware mode.
- f. As registration with a SIP Proxy server is not mandatory, it shall be possible to determine whether a registration exists for that particular subscriber when an incoming call is placed by a subscriber. This allows the CSI information to be fetched from the HLR if the subscriber is not registered. (Note: Absence of the O-CSI does not necessarily mean that the user is not registered, merely that the O-CSI may not exist for that subscriber).
- g. The information flows make no consideration for interworking with other networks (e.g. PSTN via gateways as this is considered to be outside of scope of the technical report).

8.3 Message Flows

8.3.1 Proposed Registration process

This section outlines a possible registration process based on the SIP *REGISTER* method, which allows CAMEL subscription information to be stored in the SIP Proxy Server/IPSSF. IETF RFC 2543 [4] defines the term Registrar for registration purposes and it is the SIP registrar that accepts the *REGISTER* method. In this section it has been assumed that the SIP Proxy Server and the SIP registrar are co-located. This registration process is in addition to the PDP transport layer registration (GPRS Attach/Detach and PDP context establishment as found in UMTS 24.080 and UMTS 29.060). With the SIP *REGISTER* method, it is assumed that registration with a location server takes place. As this is outside the scope of SIP to specify, the information flows for this procedure are not shown, but are assumed to take place.

Unlike H.323, registration with a server is not mandatory. Only users that wish to receive incoming calls need to register with a SIP Proxy server and a location server. Callers placing calls are not required to register. The information flows for the registration procedure are shown in Figure 21 and elaborated in the following text:

- {1} The MS attaches to the network using existing GPRS procedures. This involves an attach request to the SGSN and a location update sequence between the SGSN and the HLR.
- {2} The MS activates a PDP context to establish an IP session with the local proxy SIP server in the visited network. Mechanisms for the discovery of the SIP Proxy server are for further study.
- {3} The MS sends a *REGISTER* method to the SIP Proxy server.
- {4} The SIP Proxy server notifies the IPSSF/VLR of the registration attempt. The IPSSF in turn notifies the HLR. The HLR responds with an *InsertSubscriberData* message which contains the CAMEL Subscription Information (CSI) which includes the Originating CSI (O-CSI) and Terminating CSI (T-CSI). The applicability of the Supplementary Service CSI (SS-CSI) is for further study.
- {5} The SIP Proxy server acknowledges that the registration process has been completed by a *200 OK* response message.
- {6} Once the registration process is complete, the PDP session with the SIP Proxy Server may be terminated.

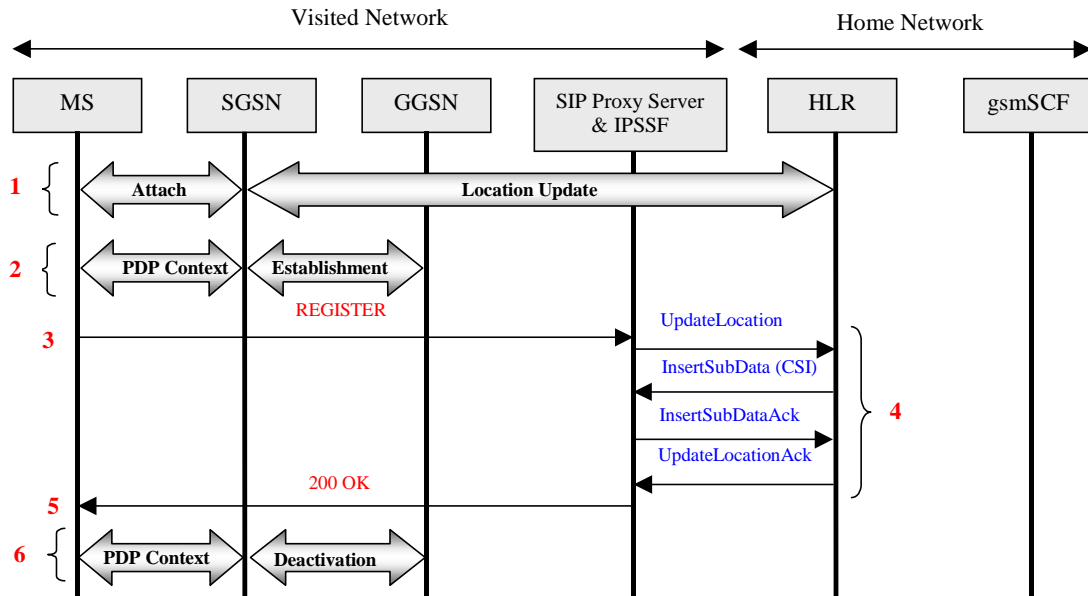

Note : Messages shown in red are SIP messages. Blue messages are MAP messages

Figure 21: Proposed registration procedure

8.3.2 Mobile Originating Call with CAMEL interaction

This section deals with the mobile originating calls that require interaction with CAMEL.

The call flows are shown in Figure 22 and are further explained below:

- {1} The MS wishes to place a VoIP call. A PDP context is established to allow an IP session to be established over the GPRS network.
- {2} The User Agent Server in the MS initiates a SIP request by issuing an *INVITE* method to the SIP Proxy server.
- {3} The VLR functionality in the IPSSF is checked to determine if the calling party has previously registered. If no registration found, then step {4} is followed. If the IPSSF determines that the calling user has a valid registration then step {5} is followed.
- {4} The IPSSF establishes a dialogue with the HLR of the subscriber's network. An *UpdateLocation* message is sent to the HLR. The HLR responds by sending an *InsertSubscribersData* message, which may contain the CAMEL Subscription Information, including O-CSI, T-CSI and the SS-CSI.
- {5} The O-CSI data is analysed and if the necessary triggering criteria are met, the gsmSCF is invoked via an *InitialDP* message.
- {6} The SIP Proxy server will route the call based on the instructions received by the service logic in the gsmSCF. The remainder of the information flows will vary according to the service logic and are not shown.

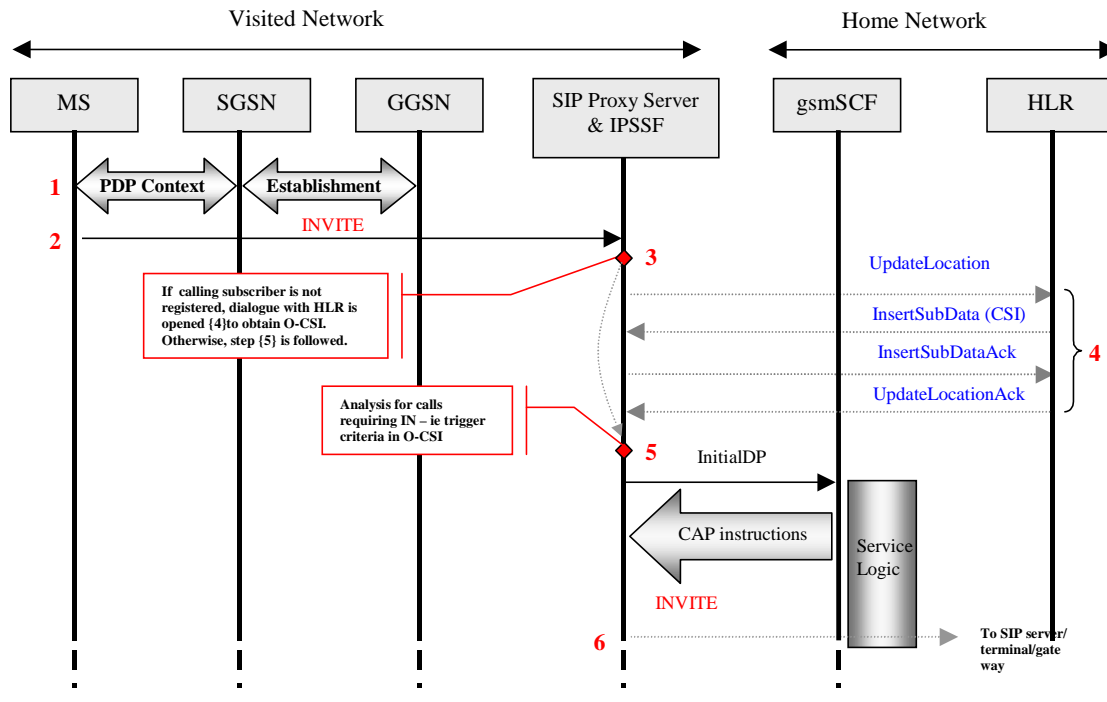

Figure 22: MO Call with CAMEL interaction

8.3.3 Mobile Terminating Call with CAMEL interaction

This section deals with the CAMEL interaction for mobile terminated calls. A CAMEL service is triggered if the triggering criteria held in the called subscriber's T-CSI matches the characteristics of the incoming call. The information flows are shown in Figure 23 and further explained below:

- {1} The terminating SIP Proxy server receives an INVITE method.
- {2} The T-CSI is analysed and the triggering criteria are check against the particulars of the incoming call. A terminal must register with a server to be able to accept incoming call and has been assumed that since this registration has taken place; the T-CSI is available at the server.
- {3} If the necessary triggering criteria are met, the gsmSCF is invoked and a CAP dialogue established between the IPSSF and the gsmSCF.
- {4} Instructions are received from the gsmSCF on how the call is to be routed.
- {5} The SIP Proxy server will route the call based on the instructions received by the service logic in the gsmSCF. A network initiated PDP context is established in order to deliver the *INVITE* method to the User agent server. As the rest of the information flows will vary according to the service logic, the remained of the information flows are not shown.

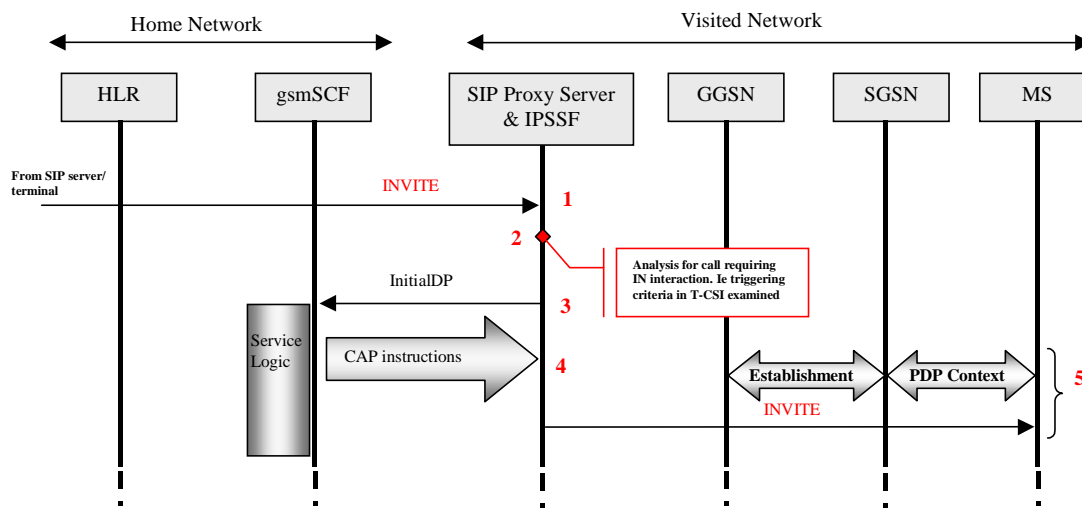

Figure 23: MT Call with CAMEL interaction

8.4 State Models

8.4.1 Mapping SIP message to CAMEL Basic Call State Models

This section deals with how the Originating Basic Call State Model (O-BCSM) Points in Call (PICs) and Detection Points (DPs) or 'triggers' are mapped to the appropriate SIP messages. Although a mapping is possible, there is not always the same analogy between the circuit switched environment that the CAMEL BCSM were designed for and the packet environment, and as a result a direct mapping is not always possible. The state models for the CAMEL O-BCSM and the T-BCSM are based on the emerging CAMEL Phase 3 draft specifications as identified in reference[11].

For simplicity, the information flows in the Figures of the following subsections do not show the flows between the GPRS network nodes (SGSN and GGSN) and between the gsmSCF and IPSSF.

8.4.2 Mapping to Originating BCSM for MO calls

The mapping between the SIP methods and responses for O-BCSM relating to Mobile Originating Calls are shown in Figure 24. Only the successful case is described. Further work is necessary to describe all other scenarios. The information flows are further described below :

- {1} *INVITE* method arrives at the proxy server, indicating that the MS has requested to set up a call. SIP Proxy server determines if O-CSI exists for this user.
- {2} Analysis of the O-CSI takes places and if necessary triggering criteria are met, gsmSCF is invoked. DP CollectedInfo may be reported.
- {3} Instructions received from the gsmSCF on how the call is to be routed, together with which EDPs are armed. State Routing_And_Alerting entered. *INVITE* method forwarded to destination.
- {4} A response '*200 OK*' indicates that the destination has accepted in session invitation, indicating that a session has been established. State O_Active is entered, DP O_Active may be reported to the gsmSCF and an *ACK* is sent to the originating party.

- {5} Either party may release the call with a *BYE* method. On receipt of the *BYE*, transition to the PIC *O_Null&Authorise_Origination_Attempt_Collect* takes place and the DP *O_Disconnect* may be reported to the gsmSCF.

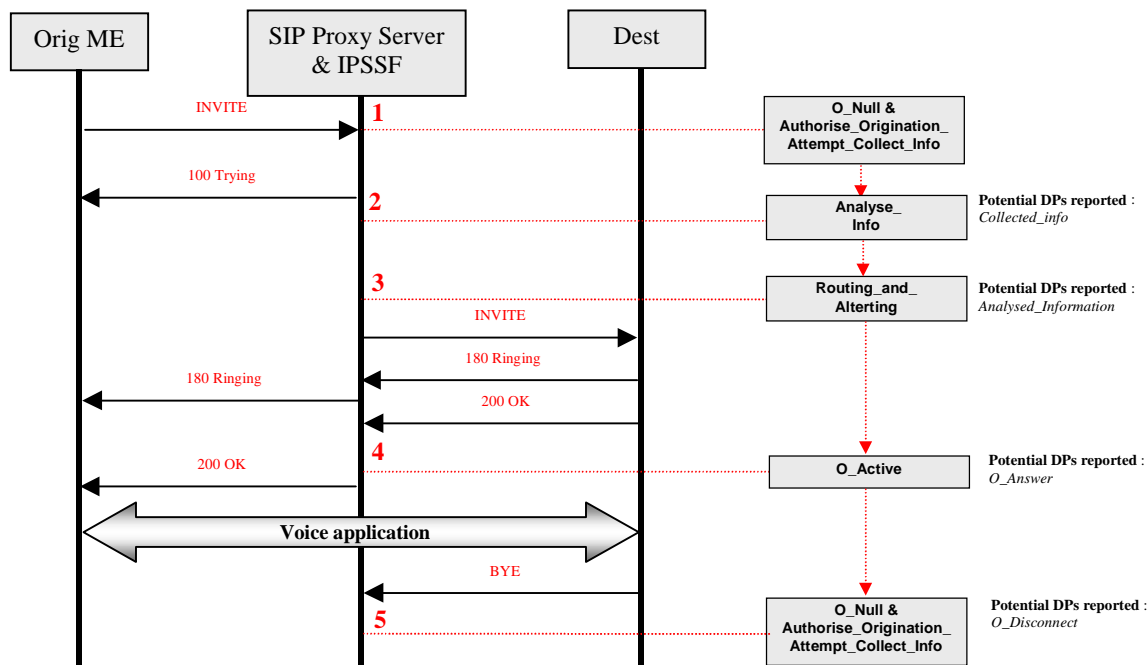

Figure 24: Message flows and corresponding CAMEL O-BCSM for successful call establishment

8.4.3 Terminating BCSM for MT Calls

The mapping between the SIP methods and responses for T-BCSM and Mobile Terminating Call is shown in Figure 25. The information flows further described below :

- {1} *INVITE* method arrives at the destination SIP Proxy server. Server/IPSSF determines if a T-CSI exists for the called user
- {2} T-CSI is analysed and if necessary triggering criteria are met, gsmSCF is invoked. Transition to state *TerminatingCallHandling* and DP *Terminating_Attempt_Authorised* may be reported.
- {3} Call accepted by the terminating party. DP *T_Answer* may be reported to the gsmSCF, state *T_Active* entered.
- {4} Either party may terminate the call by sending a *BYE* and transition to PIC *T_Null* takes place and the DP *T_Disconnect* may be reported.

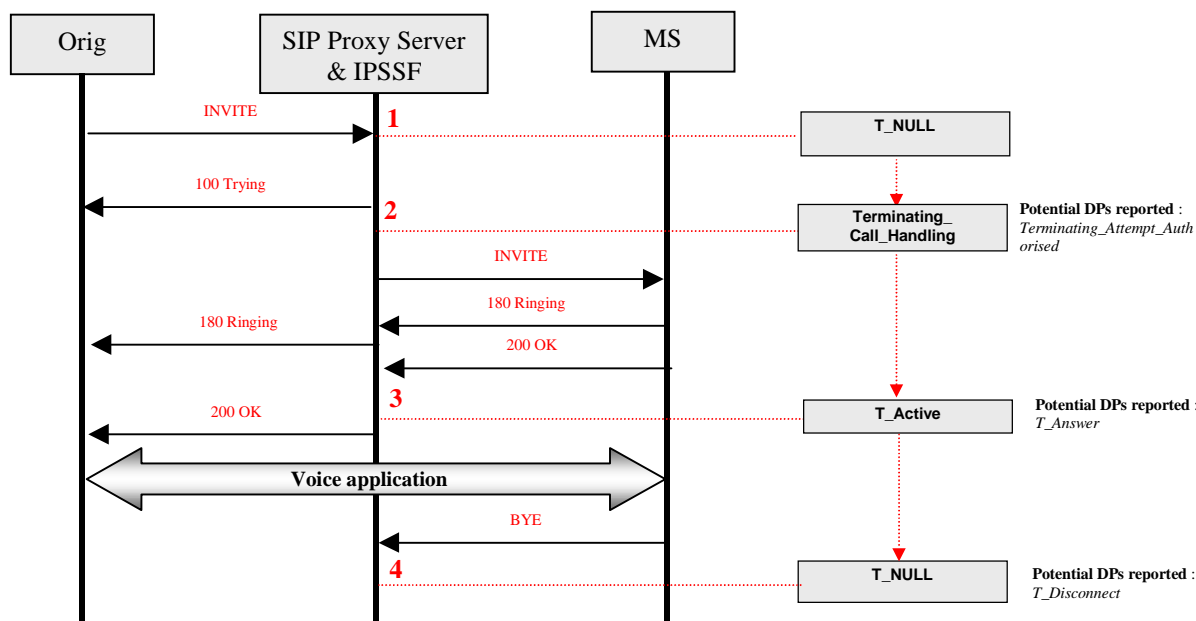

Figure 25: Message flows and corresponding PIC in the CAMEL T-BCSM for successful call delivery

8.4.4 Unsuccessful MT Call Delivery

This subsection explores the mapping and the reporting of the DPs that may be encountered when the call is not successfully established. The information flows are shown in Figure 26 and further explained below:

- {1} *INVITE* method arrives at the destination SIP proxy server. Server/IPSSF determines if a T-CSI exists for the called user
- {2} T-CSI is analysed and if necessary triggering criteria are met, gsmSCF is invoked. Transition to state *TerminatingCallHandling* and DP *Terminating_Attempt_Authorised* may be reported.
- {3} The destination does not accept the incoming call – reason response may be any value in 4xx response range. The mapping of client error codes (4xx) to the possible Detection Points in PIC *Terminating_Call_Handling* is not all that straight forward. For example, the DP *T_CallHandlingFailure* can capture most of the 4xx error codes, and *T_Busy* can be mapped on to 486 Busy Here, it is not clear how *T_Abandon* and *T_No_Answer* can be mapped on to the error codes. Although further work is required, the problem is not unique to GSM and CAMEL. Work in other standards organisations needs to be investigated to determine similar issues.

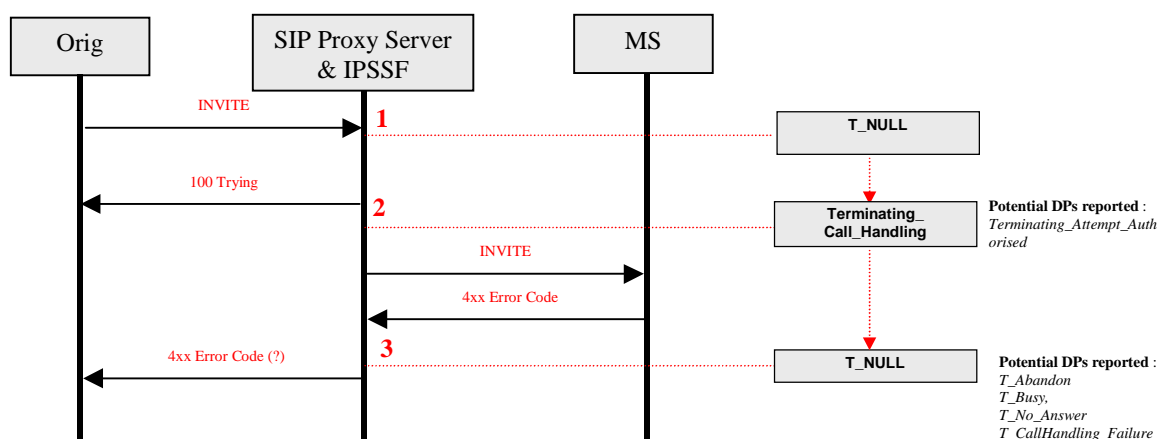

Figure 26: Message flows and corresponding PIC in the CAMEL T-BCSM for unsuccessful call establishment.

8.5 CAMEL Integration

Integration of CAMEL functions with SIP Proxy Server functions may require enhancements to SIP standards or CAMEL standards. Some initial work has been done to identify the standards that may need to be enhanced and to assess the extent of the changes required.

8.5.1 Impact on SIP Standards

Section 8.4 describes and illustrates how SIP messages may be mapped to O_BCSM and T_BCSM Detection Points (DPs) at the SIP Proxy Server/SSF. When studying the Figures it can be seen that some CAMEL Phase 3 DPs (such as O_Active) have good correspondence with SIP messages at the SIP Proxy Server, while other DPs require more detailed analysis. At this level of analysis it seems likely that changes to SIP may not be needed.

8.5.2 Impact on CAMEL and other UMTS Standards

It is likely that some functional modelling additions and some CAP message information element additions will be needed. It is also likely that some HLR/VLR data and MAP protocol additions may be needed. It is of course very difficult to assess and describe exactly how much effort and meeting time is required to effect these changes. In comparison to previous CAMEL work on Phase 1, Phase 2 and Phase 3, in the author's opinion the effort required is probably more than was necessary to complete GPRS inter-working in CAMEL Phase 3, but probably less than the work necessary to complete CAMEL Phase 1.

The major impact of these changes concerns documents 22.078, 23.018, 23.078, 29.078 and 29.002

8.6 Service Impacts

The combination of CAMEL and SIP (as described in this report) may support some GSM supplementary services, such as unconditional call forwarding (subject to some re-engineering) and perhaps most operator specific services (depends on the extent of any reduced functionality necessary for integration). Every service needs to be studied in detail to determine exactly what can be supported. Interworking with SIP extensions for call control services is another aspect. Again every service needs to be studied in detail.

8.7 Multimedia Evolution

The proposal in this report is focused on voice not multimedia. Control of multimedia services requires further study. However, the proposal does not in any way preclude CAMEL evolution to control multimedia services supported by SIP. It is likely that further enhancements to the protocols and functions listed in section 8.5.2 (e.g., MAP, CAP, HLR, VLR, CSE) may be necessary, depending on the nature of the multimedia service support required.

8.8 Advantages

The following advantages have been identified:

- Maximises the re-use of existing functional entities, protocols and services. Such reuse decreases the development and ownership costs allowing existing familiar 2G services to be provided to 3G subscribers at an early stage.

Minimum changes to the CSE for the support of legacy services. There are several IN/CAMEL services already deployed such as PrePaid, VPN, Mobile Number Portability, etc which may be used in a voice over IP network.

8.9 Disadvantages

The following disadvantages have been identified:

- This approach is not in line with the work currently underway in ETSI SPAN 3 (Services and Protocols), in particular a work item addressing IN support for voice over IP on the H.323 architecture and associated protocols in association with the TIPHON project.
- Introduces new functional entity 'IPSSF', which provides the necessary mapping between the SIP Proxy Server and the CSE. However, this functional entity is based on the functions already provided by a VMSC/GMSC, where already standardised process such as the gsmSSF can be reused.

The interface between the SCS/CSCF and the IPSSF requires further study.

9 Work in other Standards Groups

9.1 3GPP

9.1.1 System Architecture Working Group 2 (S2)

The 3GPP S2 group has overall system architecture responsibility for the GSM/GPRS evolved system within the 3GPP organisation and also has close linkage with the ETSI SMG12 (GSM/GPRS) system architecture group.

The S2 group is investigating the architectural impacts and linkages involved with providing IN (CAMEL) based features into the mobile environment including the impacts of aspects such as roaming, Mobile Originated and Terminating calls, interactions with GSM standardised supplementary services and distributed service control/SSF issues across network boundaries. Items currently under study include the addition of CAMEL features for GPRS (beyond CAMEL Phase 3) and the opportunities to include further location based capabilities. CAMEL is also continuing into the UMTS area to include the Open Service Architecture (OSA) aspects.

3GPP document 23.121 specifies architectural requirements.

9.2 ETSI

9.2.1 TIPHON

TIPHON Working Group 7 is studying the implementation of TIPHON networks in a mobile environment, and has been in existence since the beginning of 1999. TIPHON mobility is user and service mobility in the context of the VoIP application. The group has an understanding with 3GPP S2 to liaise over IP activities. It is currently planning on producing 3 main documents:

07.001 Analysis of existing roaming techniques applicable to TIPHON mobility services

07.002 Investigation of synergies and common requirements between TIPHON networks and wireless systems as they are currently being developed by other bodies.

07.003 Mobility and Access to Wireless Systems: Extensions to Requirements, Architectures and Protocols

However, at the present moment only 07.001 has any significant text associated with it. The document is a review of existing mobile networks and specifically lists supplementary services as an open issue. In section 5.1 the GSM network is described, and CAMEL identified as the Intelligent Network service within GSM used to provide service mobility where the end user should not see any difference in the services provided by the IN nodes irrespective of the user's location and terminal used. Similarly section 5.7 describes the GPRS network, section 5.9.4 introduces Session Initiation Protocol, and section 5.10 details the mobile extension to H.323.

At the July 1999 TIPHON 14 meeting, working group 7 discussed a document (14TD054) received from ITU-T SG16 for information concerning new work recently approved on mobility for H.323. The contribution stirred discussion, as the solution was seen as conflicting with the general attempt within TIPHON to work towards a layered architecture.

9.2.2 SPAN3

ETSI SPAN (Services and Protocol for Advanced Networks) is ETSI's core competence centre for fixed networks standardisation including IP based networks. SPAN3 (formerly SPS3) is the competence centre for IN Activities, including generic operations for INAP mobility. SPS3 work on Core INAP CS-3 has been split into two streams. CS-3.1 comprises CS2 and CAMEL Phase 3, while CS-3.2 looks at fixed network requirements and will be based on the ITU CS3 output. Both are due for completion by the end of 1999 and will be merged in Core INAP CS4, due for completion at the end of 2000.

CS-3.2 contains a work item addressing IN support for voice over IP based on the H.323 architecture and associated protocols in conjunction with the TIPHON project. A liaison statement from SPS3 to TIPHON entitled "Using Intelligent Networks in a Tiphon Architecture" was written in June 1999, giving the following proposals

- The IN infrastructure shall be independent of the IP telephony signalling protocol (SIP, H323,...).
- The call control and consequently IN control shall be at least at the edge of the network i.e. nearest to the user in a Local Exchange and between two operators in an Inter-operator Gateway.

9.3 IETF

The Routing area contains the IP Routing for Wireless/Mobile Hosts (mobileIP) Working Group. It has developed routing support to permit IP nodes (hosts and routers) using either IPv4 or IPv6 to seamlessly roam among IP sub-networks and media types. The group has produced an Internet draft entitled "Requirements on Mobile IP from a Cellular Perspective" which considers MobileIP as a macro-mobility solution for cellular networks. This document does not address the issues surrounding the provision of supplementary services.

The Transport area contains the IP Telephony (iptel) working group and the Media Gateway Control (MEGACO) working group.

The Internet draft “SIP Call Control Services” describes a set of extensions to SIP which allow for various call control services. Example services include blind transfer, transfer with consultation, multi-party calls, bridged conferences, and ad-hoc conferencing. The Internet draft “Accessing IN services from SIP networks” proposes a mapping from the states of the IN call model to the states of SIP, an Internet call signalling protocol.

9.4 ITU-T

9.4.1 SG11

Study Group SG11 is responsible for studies relating to signalling requirements and protocols for telephone, N-ISDN, B-ISDN, UPT, mobile and multimedia communications. SG11 is responsible for most of the Q-Series standards, including Q.931. Questions under study by the group include:

- 5/11 Intelligent network capability sets
- 6/11 New signalling capabilities and requirements for advanced broadband multimedia services
- 7/11 Signalling, call handling and management requirements for universal personal telecommunications and for user mobility in future public land mobile systems
- 13/11 Network signalling for the support of broadband services and third generation land mobile networks (FPLMTS)
- 22/11 Intelligent Network Application Protocol (INAP)
- 24/11 Signalling requirements for emerging land mobile and satellite mobile - Network and Inter-network Signalling Requirements

9.4.2 SG16

Study Group16 is responsible for studies relating to multimedia service definition and multimedia systems, including the associated terminals, modems, protocols and signal processing. SG16 is responsible for the H-Series standards, including H.323, as well as parts of the T-, G-, and F-Series. Questions under study by the group include:

- 13/16 Packet switched multimedia systems and terminals

This question covers the H.323 standard, of which Annex H studies H.323 Mobility. The annex has the following objectives:

- Define functional requirements for H.323 mobility at the application level in a transport independent way.
- Examine whether any new messages or message elements need to be created in H.323 for supporting mobility
- Facilitate interoperability for implementation of H.323 mobility over any specific networking environment such as wireless/PSTN

10 Questions & Answers

Early drafts of this FTR were presented to 3GPP CN WG2a and a small number of questions were raised. The questions and answers are recorded here.

Q. In our work, are we considering IN control of RAS signalling or for call control or both?

A. Control of RAS signalling is out of scope.

Q. How does the architecture support the playing of tones and announcements?

A. This is a problem not unique to CAMEL and is one of many issues that we have not addressed. We felt that it is appropriate to address this aspect as part of a more detailed study.

Q. Are we only considering CAP over SS7?

A. We have not excluded the possibility of CAP over IP, this possibility depends on the outcome of SIGTRAN work and the MAP over IP work in CN2B. CAMEL control of VoIP services is independent of whether SS7 or IP is used for the lower layer signalling transport.

Q. What considerations are there for 'fast start' and what impact does this have?

A. Requires further study.

Q. How are we incorporating the work output from MEGACO?

A. As far as we are aware MEGACO work does not directly impact CAMEL control of VoIP services but further study is required.

11 Conclusions & Recommendations

This report has demonstrated how CAMEL can be used to control VoIP services in an all IP network using H.323 or SIP. The analysis has been carried out at a high level sufficient to identify that further detailed design and specification work should lead to a viable solution. At this level of analysis no preference for H.323 or SIP was evident. Based on this evidence, either H.323, SIP or both could be successfully employed.

It is recommend that detailed specification work is included in the scope of CAMEL for Release '2000 subject to decisions in S2 that may impact on architecture and the choice of VoIP solution (H.323 or SIP or both). It is desirable that the list of standard services (such as conditional call forwarding), should be agreed at an early stage to allow maximum time for enhancing CAMEL standards.