

---

**TSG-SA WG 1 (Services) meeting #14  
Kobe, Japan, 5-9 November 2001**

**S1-011322  
Agenda Item:**

**Title:** Focus of TR 22.941

**Source:** TSG SA1

**To:** SA2, CN1

**cc:** SA, CN, T

**Contact Person:**

**Name:** TR 22.941 Rapporteur, Randolph Wohlert, SBC Communications

**E-mail Address:** [rwohlert@tri.sbc.com](mailto:rwohlert@tri.sbc.com)

---

This liaison is provided for the purpose of promoting common understanding, and soliciting contributions to TR 22.941, the IP Framework Report. SA1 would like to bring to the attention of others that one of the most significant aspects of TR 22.941 is validation of the degree to which solutions meet key requirements for the deployment of IP Multimedia Services.

SA1 has made significant progress in identifying key requirements, and respectfully requests input from other groups regarding their views on the degree to which the requirements are met. Each group is kindly asked to provide contributions on their topics of expertise to SA1 in the form of proposed text for section 11 of the Report.

Note: the solutions provided to meet specific requirements need to also meet general requirements for provision of a full end to end solution including charging and billing, security, privacy, and authorization.

If the key requirements are not adequately met then the focus of the work effort should be shifted accordingly. Key requirements are identified in sections 7 and 8 of the TR, and the latest version is attached for your consideration.

Responses should be provided in the form of a table with the following structure:

<u>Requirement</u>	<u>Solution</u>	<u>How Requirement Met</u>
--------------------	-----------------	----------------------------

**Attachment:**

TR 22.941 version 0.7.7

**Actions:**

1. SA2 and CN1

Please provide input to TR 22.941 indicating provided solutions to the requirements identified in the TR in sections 7 and 8, and how the requirements are met.

2. SA, CN, T

Please request additional working groups to take this into consideration as may be appropriate.

**Date of Next SA1 Meetings:**

Title	Date	Location	Country
SA1 Adhocs	14 – 18 Jan 02	Phoenix	United States
SA1#15	11 – 15 Feb 02	Saalfelden	Austria

# 3GPP TR 22.941 V0.7.7 (2001-11)

---

*Technical Specification*

---

**3rd Generation Partner  
Technical Specification Group Services**



**Aspects;  
IP Based Multimedia Services Framework;  
Stage 0  
(Release 5)**

The present document has been developed within the 3<sup>rd</sup> Generation Partnership Project (3GPP™) and may be further elaborated for the purposes of 3GPP.

The present document has not been subject to any approval process by the 3GPP Organizational Partners and shall not be implemented.

This Specification is provided for future development work within 3GPP only. The Organizational Partners accept no liability for any use of this Specification.

~~Specifications and reports for implementation of the 3GPP™ system should be obtained via the 3GPP Organizational Partners' Publications Offices.~~

---

Keywords

---

<keyword[, keyword]>

**3GPP**

Postal address

---

3GPP support office address

---

650 Route des Lucioles - Sophia Antipolis  
Valbonne - FRANCE  
Tel.: +33 4 92 94 42 00 Fax: +33 4 93 65 47 16

Internet

---

<http://www.3gpp.org>

---

**Copyright Notification**

No part may be reproduced except as authorized by written permission.  
The copyright and the foregoing restriction extend to reproduction in all media.

© 2001, 3GPP Organizational Partners (ARIB, CWTS, ETSI, T1, TTA, TTC).  
All rights reserved.

---

# Contents

<b>2</b>	<b>FOREWORD</b> .....	<b>8</b>
<b>3</b>	<b>INTRODUCTION</b> .....	<b>8</b>
3.1	OVERVIEW OF DOCUMENT STRUCTURE .....	8
<b>4</b>	<b>SCOPE</b> .....	<b>10</b>
<b>5</b>	<b>REFERENCES</b> .....	<b>10</b>
<b>6</b>	<b>DEFINITIONS, SYMBOLS AND ABBREVIATIONS</b> .....	<b>12</b>
6.1	DEFINITIONS.....	12
6.2	ABBREVIATIONS.....	12
<b>7</b>	<b>SERVICE EXAMPLES</b> .....	<b>12</b>
7.1	MULTIMEDIA SERVICE .....	13
7.1.1	<i>General Description</i> .....	13
7.1.2	<i>Key Requirements</i> .....	14
7.2	EMERGENCY CALL.....	19
7.2.1	<i>General Description</i> .....	19
7.2.2	<i>Requirements</i> .....	19
7.3	MOBILE NUMBER PORTABILITY .....	19
7.3.1	<i>General Description</i> .....	19
7.3.2	<i>Key Requirements</i> .....	19
7.4	IDENTIFICATION RESTRICTION.....	20
7.4.1	<i>General Description</i> .....	20
7.4.2	<i>Key Requirements</i> .....	20
7.5	LAWFUL INTERCEPTION.....	20
7.5.1	<i>General Description</i> .....	20
7.5.2	<i>Key Requirements</i> .....	20
7.6	MALICIOUS CALL TRACE.....	21
7.6.1	<i>General Description</i> .....	21
7.6.2	<i>Key Requirements</i> .....	21
7.7	GLOBAL TEXT AND TOTAL CONVERSATION .....	21
7.7.1	<i>General Description</i> .....	21
7.7.2	<i>Key Requirements</i> .....	22
7.8	MOBILE VIRTUAL PRIVATE NETWORK .....	23
7.8.1	<i>General Description</i> .....	23
7.8.2	<i>Key Requirements</i> .....	23
7.9	LOCAL SERVICES.....	24
7.9.1	<i>General Description</i> .....	24
7.9.2	<i>Key Requirements</i> .....	24
7.10	PRESENCE SERVICE.....	25
7.10.1	<i>General Description</i> .....	25
7.10.2	<i>Key Requirements</i> .....	25
7.11	INSTANT MESSAGING .....	26
7.11.1	<i>General Description</i> .....	26
7.11.2	<i>Requirements</i> .....	26
7.12	GAMING .....	26
7.12.1	<i>General Description</i> .....	26
7.12.2	<i>Requirements</i> .....	26
7.13	PREPAID SERVICE.....	27
7.13.1	<i>General Description</i> .....	27
7.13.2	<i>Key Requirements</i> .....	27
7.14	INTERACTIVE CUSTOMER CARE SERVICES .....	27
7.14.1	<i>General Description</i> .....	27

7.14.2	Key Requirements.....	27
7.15	MULTIMEDIA GROUP CALL, MULTIMEDIA BROADCAST CALL .....	27
7.15.1	General Description.....	27
7.15.2	Key Requirements.....	27
7.16	PRIORITY SERVICE .....	27
7.16.1	General Description.....	27
7.16.2	Key Requirements.....	27
7.17	DISTRIBUTED SPEECH RECOGNITION BASED VOICE PORTAL SERVICE .....	28
7.17.1	General Description.....	28
7.17.2	Key Requirements.....	28
7.18	LOCATION SERVICES .....	28
7.18.1	General Description.....	28
7.18.2	Key Requirements.....	28
7.19	HOME MONITORING .....	30
7.19.1	General Description.....	30
7.19.2	Key Requirements.....	30
7.20	WHITE BOARD COMMUNICATION.....	31
7.20.1	General Description.....	31
7.20.2	Key Requirements.....	31
<b>8</b>	<b>SYSTEMS ENGINEERING CONSIDERATIONS.....</b>	<b>32</b>
8.1	IP MULTIMEDIA CORE NETWORK .....	32
8.1.1	General Description.....	32
8.1.2	Key Requirements.....	32
8.2	CUSTOMER CARE .....	33
8.3	TELECOMMUNICATIONS MANAGEMENT.....	33
8.4	SERVICE CONTROL.....	33
8.5	CHARGING AND BILLING .....	33
8.5.1	Quality of Service (QoS) Based Charging.....	33
8.5.1.1	General Description.....	33
8.5.1.2	Key Requirements.....	33
8.6	CONSISTENT DELIVERY OF BASIC SERVICES .....	33
8.7	CAPABILITY DISCOVERY AND SERVICE NEGOTIATION.....	33
8.8	END TO END QUALITY OF SERVICE .....	34
8.8.1	General Description.....	34
8.8.2	Key Requirements.....	34
8.9	QUALITY OF SERVICE MANAGEMENT.....	34
8.9.1	General Description.....	34
8.9.2	Key Requirements.....	35
8.10	INTEROPERABILITY BETWEEN VARIOUS MECHANISMS .....	35
8.11	USER CONTROL.....	35
8.12	SECURITY.....	35
8.12.1	Integrity.....	35
8.12.2	Authentication .....	35
8.12.3	Authorization.....	35
8.12.4	Privacy .....	35
8.13	INTERWORKING.....	35
8.13.1	2G / 3G Interworking .....	35
8.13.2	GSM / IS-41 Interworking .....	35
8.13.3	Interdomain Interworking .....	35
8.14	HANDOVER .....	35
8.15	ROAMING .....	35
8.16	ACCESS NETWORK CONSIDERATIONS .....	35
8.17	CONFORMANCE TESTING .....	35
<b>9</b>	<b>REQUIREMENTS CROSS REFERENCE.....</b>	<b>35</b>
<b>10</b>	<b>ENABLERS .....</b>	<b>35</b>
10.1	TOOLKITS.....	35
10.2	USER DEVICES .....	35

10.3	NETWORK ARCHITECTURE.....	35
10.3.1	Radio Access Network.....	36
10.3.2	Core Network.....	36
10.4	PROTOCOLS.....	36
10.4.1	Quality of Service Enablers.....	36
10.4.2	QoS Management Enablers.....	37
<b>11</b>	<b>VERIFICATION.....</b>	<b>38</b>
11.1	VERIFICATION METHODS.....	38
11.1.1	Service Examples, Requirements and Service Enablers.....	38
11.1.2	Verification of Service Enablers.....	40
	<b>ANNEX A (INFORMATIVE): CHANGE HISTORY.....</b>	<b>41</b>
	<b>ANNEX B (INFORMATIVE): ADDITIONAL SERVICE EXAMPLES.....</b>	<b>41</b>
<b>1</b>	<b>MOBILE INTERNET ACCESS.....</b>	<b>42</b>
<b>2</b>	<b>CUSTOMISED INFOTAINMENT/EDUTAINMENT.....</b>	<b>42</b>
<b>3</b>	<b>E-COMMERCE AND M-COMMERCE.....</b>	<b>42</b>
<b>4</b>	<b>MULTIMEDIA MESSAGING INFORMATION SERVICE.....</b>	<b>43</b>
<b>5</b>	<b>PHONE TO PHONE OBJECT TRANSFER.....</b>	<b>43</b>
<b>6</b>	<b>PHONEBOOK SYNCHRONISATION.....</b>	<b>43</b>
<b>7</b>	<b>PEER TO PEER GAMING.....</b>	<b>43</b>
<b>8</b>	<b>SERVER BASED GAMING.....</b>	<b>45</b>
<b>9</b>	<b>MULTIMEDIA GROUP CALL, MULTIMEDIA BROADCAST CALL.....</b>	<b>47</b>
<b>10</b>	<b>DISTRIBUTED SPEECH RECOGNITION BASED VOICE PORTAL SERVICE.....</b>	<b>48</b>
<b>11</b>	<b>QUALITY OF SERVICE (QOS) BASED CHARGING.....</b>	<b>51</b>
	<b>ANNEX C (INFORMATIVE): IP BASED MULTIMEDIA SERVICES ROADMAP.....</b>	<b>52</b>
	<b>ANNEX D: BACKGROUND INFORMATION.....</b>	<b>55</b>
<b>1</b>	<b>PRIORITY SERVICE.....</b>	<b>55</b>
<b>2</b>	<b>LOCATION SERVICES.....</b>	<b>57</b>

## Foreword

This Technical Report has been produced by the 3<sup>rd</sup> Generation Partnership Project (3GPP).

The contents of the present document are subject to continuing work within the TSG and may change following formal TSG approval. Should the TSG modify the contents of the present document, it will be re-released by the TSG with an identifying change of release date and an increase in version number as follows:

Version x.y.z

where:

- x the first digit:
  - 1 presented to TSG for information;
  - 2 presented to TSG for approval;
  - 3 or greater indicates TSG approved document under change control.
- y the second digit is incremented for all changes of substance, i.e. technical enhancements, corrections, updates, etc.
- z the third digit is incremented when editorial only changes have been incorporated in the document.

## Introduction

Specifications are being developed within 3GPP, and co-operatively with other organisations (i.e. IETF) that will enable the deployment of IP based multimedia services. A variety of mechanisms are under consideration to provide the capabilities needed to meet the requirements of envisioned services.

This report provides a high level end-to-end systems framework that provides consideration of how the diverse mechanisms (enablers) being standardised will collectively integrate to effectively meet service requirements and enable the deployment of envisioned services. Additionally, this report serves to document the collective vision of 3GPP, ensure consideration of end-to-end service issues, and as may be warranted, facilitate the focus of the ongoing work.

## Overview of Document Structure

In accordance with the above objectives, this Report is structured in the following logical manner:

- Introductory Sections
  - Contents
  - Foreword
  - Introduction
- Scope
- References
- Definitions, Symbols and Abbreviations
- Service Examples
  - Descriptions of representative IP Based Multimedia Services
  - Includes consideration of services required to meet regulatory requirements
  - This section identifies Requirements based on representative services
- Systems Engineering Considerations
  - This section identifies Requirements based on systems engineering requirements
- Requirements Cross Reference
  - This section provides an informative table indicating which Requirements may be needed to support which representative service examples.
- Enablers
  - This section describes the Enablers being standardized to meet the Requirements
- Verification
  - This section describes the degree to which the Enablers meet the Requirements
- Annex A: Change History
- Annex B: Additional Service Examples



This section serves as a placeholder for additional service examples that are under consideration (for further study).

- **Annex C: IP Based Multimedia Services Roadmap**  
This section provides information on the collective 3GPP vision, and may consider the degree to which current activities are aligned and consistent with the long term vision.
- **Annex D: Background Information**  
This section provides additional information that may be useful as background information

## Scope

This Technical Report provides a framework for IP based multimedia services within the 3GPP system. As a framework report the scope of this document is broader than that of the existing Stage 1, 2, or 3 specifications. It serves as an “umbrella” that conceptually pulls together at a high level the work of other 3GPP deliverables providing an overall cohesive view of services, their requirements from the perspective of users and service providers, the enablers of the requirements, and how the enablers meet the requirements. This document is intended to verify the ability to fulfil requirements stated elsewhere, e.g. in TS 22.101 and TS 22.228.

As such this Report contains extracts from, and reference to other specifications that should be consulted for more detailed information, e.g. TS 22.101 and TS 22.228. If a discrepancy exists between the content of this report and the referenced specifications, the content of the referenced specifications supersedes the contents of this report.

To meet its objectives this TR will:

- Identify **Requirements** determined from
  - Representative service examples reflecting the user’s and operator’s perspectives of services
  - Systems Engineering Issues as viewed from the operator’s perspective
- Describe the **Enablers** being standardised to meet the Requirements
- Provide **Verification** of the degree to which the Enablers meet the Requirements
- Describe the long term **vision** of 3GPP with respect to IP Based MultiMedia Services.
 

Note: It is an individual choice of an operator, which Service Enablers a network will support. Similarly, it is an individual choice of a terminal vendor which Service Enablers a particular terminal will support.

Consideration of CS domain based services is not within the scope of this specification. However, interworking between CS, PS, and IMS domains and subsystems, and external networks (e.g. Internet) is within the scope of this report.

Note that this report is viewed as being applicable not only to Release 5, but to subsequent releases as well. As such it captures not only the near term vision of IP based multimedia services, but the long term vision as well, and is intended to be a living document that crosses releases.

## References

The following documents contain provisions which, through reference in this text, constitute provisions of the present document.

- References are either specific (identified by date of publication, edition number, version number, etc.) or non-specific.
- For a specific reference, subsequent revisions do not apply.
- For a non-specific reference, the latest version applies. In the case of a reference to a 3GPP document (including a GSM document), a non-specific reference implicitly refers to the latest version of that document *in the same Release as the present document*.

- |      |  |
|------|--|
| [01] | 3GPP TS 21.905: 3rd Generation Partnership Project; Technical Specification Group Services and System Aspects; Vocabulary for 3GPP Specifications. |
| [02] | 3GPP TS 22.101: “UMTS Service Principles”  |
| [03] | 3GPP TS 23.107: “Quality of Service, Concept and Architecture”   |
| [04] | 3GPP TS 22.115: “Service Aspects Charging and Billing”   |
| [05] | 3GPP TR 23.955: “Virtual Home Environment (VHE) Concepts”  |
| [06] | 3GPP TS 33.800: “Principles for Network Domain Security”   |
| [07] | 3GPP TS 22.121: “Provision of Services in UMTS - The Virtual Home Environment; Stage 1”  |
| [08] | 3GPP TS 22.038: “SIM application toolkit (SAT); Stage 1”   |
| [09] | 3GPP TS 22.057: “Mobile Station Application Execution Environment (MExE); Stage 1”   |
| [10] | 3GPP TS 22.078: “CAMEL; Stage 1”   |

- [11] 3GPP TS 22.071: "Location Services (LCS); Stage 1"
- [12] 3GPP TR 22.928: "IP-based multimedia services examples"
- [13] 3GPP TS 22.228: "IP Multimedia Subsystem; Stage 1"
- [14] 3GPP TS 22.141: "Presence Service"
- [15] 3GPP TS 26.226: "Global text telephony; Transport of text in the voice channel"
- [16] 3GPP TS 23.221: "Architectural Requirements"
- [17] 3GPP TS 23.002: "Network Architecture"
- [18] 3GPP TS 23.271: "Functional Stage 2 Description of Location Services"
- [19] 3GPP TS 25.305: "Stage 2 functional specification of UE positioning in UTRAN"
- [20] 3GPP TS 25.857: "UE positioning enhancements"
- [21] 3GPP TS 23.228: "IP Multimedia Subsystem; Stage 2"
- [22] 3GPP TS 23.218: "IP Multimedia (IM) session handling; IM call model"
- [23] 3GPP TS 24.229: "IP Multimedia Call Control Protocol based on SIP and SDP; stage 3"
- [24] 3GPP TS 24.228: "Signalling flows for the IP multimedia call control based on SIP and SEP; stage 3"
- [25] 3GPP TS 29.162: "Interworking between the IM CN subsystem and IP networks"
- [26] 3GPP TS 29.163: "Interworking between the IM CN subsystem and CS networks"
- [27] 3GPP TS 33.203: "Access Security for IP based services"
- [28] 3GPP TS 32.801: "Performance Management"
- [29] 3GPP TS 23.271: "Functional Stage 2 Description of Location Services"
- [30] 3GPP TS 22.226: "Global Text Telephony: Stage 1"
- [31] ITU-T F.703 Multimedia Conversational Services
- [32] ITU-T H-series supplement 1.
- [33] 3GPP TS 32.101: "3G Telecom Management: Principles and high level requirements".
- [34] 3GPP TS 32.102: "3G Telecom Management Architecture".
- [35] 3GPP TS 32.140: "Service Operations Management; Subscription Management: Detailed Requirements and Architecture".
- [36] 3GPP, TS 32.200: "Telecommunication Management; Charging Management; Charging Principles".
- [37] 3GPP, TS 32.225: "Telecommunication Management; Charging Management; IMS Charging Data Description".
- [38] 3GPP, TS 32.600: "Telecommunication Management; Configuration Management; 3G Configuration Management concepts and requirements".
- [39] 3GPP TS 32.401: "Telecommunication Management; 3G Performance Management (PM)".
- [40] 3GPP TS 32.111-1: "Telecommunication Management; Fault Management; 3G fault management requirements".

Editor's note: IETF references to be provided.

## Definitions, symbols and abbreviations

### Definitions

**Requirements** describe the functionality needed to implement and deploy the described representative service examples. They may reflect the perspective of the end user as well as the perspective of the operator or service provider. They may include functionality for specific services (e.g. regulatory related services) or common functionality applicable to many services. Requirements may also be derived from systems engineering considerations (see section 9 of this Report) as well as service examples.

**Service Enabler:** defines a capability that may be used, either by itself or in conjunction with other Service Enablers, to provide a service to the end user. Service Enablers may include modification of the existing system architecture and protocols, or new architectural elements and protocols.

### Abbreviations

<< to be provided >>

### Service Examples

This section of the report provides representative examples of services that may be deployed using the functionality of the IP Multimedia Subsystem. The provided service examples are intended to be representative, and are not viewed as being an exhaustive list. For each of the service examples, a general, high-level service description is provided and key requirements are identified. The requirements identified are those viewed as being key from the perspective of ensuring sufficient functionality exists within the 3GPP IP Based Multimedia System to enable successful commercial deployment of services. More detailed descriptions of the services, and their requirements are provided in other Technical Specifications and Reports referenced by this Report. Additionally, informative background information for some services is provided in a subsequent appendix attached to this Report.

## 1.1 Multimedia Service

### 1.1.1 General Description

With the deployment of IP Based Multimedia Services, subscribers shall be able to access one or simultaneously multiple different types of packet based communications including those listed below (this list is not intended to be exhaustive).

- Real Time Communications
  - Voice
  - Text
  - Video
- Non-Real Time Communications
  - audio download;
  - video download;
  - audio streaming;
  - video streaming;
  - general data files;
  - text messaging (e.g. SMS);
  - emails;
  - general web browsing;
  - multi-media messaging

The IP Multimedia Subsystem provides synchronisation between the multiple components of a multimedia communication session.

The services and capabilities enabled will depend on the capabilities of the user's device and the supporting networks, and may be provided by various servers. The servers may be located in the network controlled by the network operator, or may be external to the network and controlled by a 3<sup>rd</sup> party.

Multimedia sessions may support mixed media communications including different Voice, Video, and Text communication components in the upstream and downstream communications directions. For example, a subscriber receives an urgent voice call but is currently in a situation where a verbal response is not suitable (e.g. in a meeting). Using a "special answer" option on the UE, the subscriber could accept the audio portion of the incoming call (probably delivered via an earpiece) but would only reply in a textual fashion (e.g., instant messaging, soft keys on UE with pre-programmed responses). In this manner, the subscriber could listen to the incoming voice call and could generate responses without interrupting or disturbing the meeting in progress.

In similar manner, a subscriber could also choose to initiate a mixed media interaction communications session. Under this scenario, the subscriber could initiate the call with the subscriber input is provided in a textual fashion and the return communications are provided in an audio media (again probably delivered via an earpiece).

It is also possible to provide this function with the Global Text and Total conversation service by adding the conversational text medium to the session and use that in these situations.

It shall also be possible to enable communication services where the media type changes during the active communication session, for example to support a multimedia based voice response unit. For example, using terminal equipment with the required capabilities, a customer places a voice call to the customer service center. Instead of connecting the customer to an audio unit that plays announcements and prompts for input, the current session is switched from a voice call to an interactive "data call". During this interactive "data call", textual and/or graphical representation of the various options are provided to the subscriber's UE. The customer can then browse through the choices and select the desired service. After selection by the customer, the current connection may again change media (e.g., switch back to voice call, receive a streaming video).

A user requests a multimedia session by entering the identity of the item required. This could include for example setting up a conversation with another user, and downloading one or more objects. Identities used may include SIP URLs as well as MSISDNs (E.164 numbers). These identities will allow users to identify and recognise the entities they wish to interact with in a familiar manner (e.g. people whose MSISDN they already know, or familiar names of information providers).

### 1.1.2 Key Requirements

Key requirements are organised by general topics in the following subsections. In general these requirements are applicable to all multimedia services. Requirements applicable to specific forms of general IP based multimedia services (voice, video, text, etc) are identified in additional subsections following the more generally applicable requirements.

#### User Perspective

- Users initiating a session may be informed of its progress by tones, messages or graphic display on their terminal.
- During the session, other indications may be given similarly e.g. to indicate a 3rd party is trying to attach to the session. Tones and announcements may be generated locally by the terminal (subject to terminal capability) or within the network. It should be possible to personalise announcements for a user's native language.
- During a session, users may employ one or more simultaneous and synchronised media streams providing different levels of Quality of Service, e.g. a voice comment to a graphic presentation shown on a shared screen.
- While in the session, the user shall be able to select additional objects. It shall be possible for the additional objects to be provided in a supplementary manner to the current objects or for the additional object to replace (one or more) of the current object(s). The new object's ability to replace or be supplementary to current ongoing object(s) shall be controllable by the end users in a manual or automatic manner.

#### Addressing and Identities

- The user shall be able to address an object using the following methods as applicable:
  - by entering a SIP URL using a terminal keyboard, or via an external device connected to the terminal, or via any other input device
  - by selecting the SIP URL stored in the terminal or on a (U)SIM card
  - by following a hyperlink presented on the terminal's screen (e.g. as part of a presented object or after a push operation (e.g. an advertisement)
  - By entering or selecting a number in E.164 format
- It shall be possible to allow sessions based upon numbers and identities that are not globally unique (for example VPN short number or friendly name ranges that only have meaning within a non-public entity). It should be possible to associate a user assigned nickname with an E.164 or URL identity. (Note: this may be a part of the User's Profile).
- The called party is sent the identity of the caller unless specifically withheld. The identity used will depend on the capabilities of the networks but could include E.164 number or SIP URL or even an icon.

#### Service Specific Considerations

- Authorisation for the use of the service will be under the control of the home network operator.
- Deauthorisation for the use of the service will be under the control of the home network operator.
- Registration with the IMS will allow the use of IP based multimedia services, subject to authorisation and barring conditions.
- Registration with one or more object servers may also take place.
- Deregistration from the IMS will prevent the use of IP based multimedia services
- Deregistration from object servers may also take place.
- The user, a 3rd party service provider, and the network operator should be able to activate the various multimedia service features including redirection and barring.
- The user, a 3rd party service provider, and the network operator should be able to deactivate the various multimedia service features including redirection and barring.

#### Distribution, Downloading, Terminal Capabilities...

- IP based multimedia services shall be able to securely download trusted executable modules (e.g. Java applets) as part of the presented object.

## Interworking with Other Services

- Interworking will be required with other types of networks. When interworking with legacy networks, the capability to transfer media items may not always be possible due to limitations of the other network. It shall always be possible, however, to set up a voice conversational session with any user on any other type of voice telecommunications network.

## Roaming Considerations

- A user shall be able to use Multimedia Services in any compatible mobile network where there is a roaming agreement. The serving network may charge the roamer for originated sessions.
- All session control functions (e.g. setting/cancelling barring etc) should be available in the roamed-to network in the same way as they are in the home network. They should also be presented to the user in a consistent way (e.g. in accordance with the Virtual Home Environment concept).
- It shall be possible for the roamed to network to provide Multimedia Service objects to inbound roamers. These may be used to provide multi-media access to local services provided via the roamed to network.

## Session Handling

- It shall be possible to:
  - Create a session containing a voice media component.
  - Terminate a session.
  - Negotiate capabilities of the terminal, at session set up and at modifications (e.g. speech Codec negotiation).
  - Join an ongoing session (conference call) from a mobile or non-mobile (FFS) terminal.
  - Set up sessions to multiple destinations (multi-party).
- The network shall support the option to encrypt the voice component and signalling of a basic voice call.
- The user shall be able to bar certain types of sessions, ranging from all sessions to sessions based on type of terminating service, etc.
- The network operator shall be able to bar certain types of sessions. The criteria used to select the barring may differ from that used by the user.
- The user shall be able to set up sessions to multiple destinations (multi-party).
- The user shall be able to temporarily suspend the session (i.e. put the call on hold).
- It shall be possible to alert a busy user to another incoming call and provide the user with the ability to accept or reject it.
- The user shall be able to suspend an ongoing presentation session in order to initiate a new outgoing session or accept an incoming session/call. The user shall further be able to present an additional object, requiring unused terminal resources (screen, keyboard, codecs etc.) without suspending the ongoing presentation session.

Note: The ability to download, configure, and setup an application (client) in a terminal is for further study.

## Basic Voice Service

- Subscribers shall be able to make and receive conversational class voice calls via the IMS to/from all types of networks (within IMS, GSM, PSTN etc.).
- Callers in 3GPP compatible systems should be able to use default codecs to ensure end-to-end compatibility.

Note: The Default Codec for voice is AMR within 3GPP, except for GERAN and CS combination it is FR.

- The basic call features according to 22.228 [13] (e.g. redirection, barring, calling party identity etc) should work across 3GPP compatible networks including when roaming. They should also work across other types of network subject to the capability of that network.
- The user can make and receive calls in any compatible mobile network where there is a roaming agreement. The roamer is charged for the calls he makes (and receives, if appropriate) by the serving network.
- All call control functions (e.g. setting/cancelling redirection, barring etc) should be available in the roamed-to network in the same way as they are in the home network. They should also be presented to the user in a consistent way (VHE concept).
- The network should support the option to encrypt the voice component and signalling of a basic voice call.
- Allow calls to be set up using E.164 or SIP URL identifiers.
- It should be possible to associate a user assigned nickname with an E.164 or URL identity. (Note: this may be a part of the User's Profile).
- Transmission of DTMF tones end-to-end shall be supported during a call, in order to allow the users be able to signal across the networks.

Note: The ability to download, configure, and setup an application (client) in a terminal is for further study (i.e. not viewed as being critical to basic voice call in the release 5 timeframe, although critical to some applications, such as gaming).

## Text Service

- Text service can be either real time (e.g. GTT) or non real time (e.g. SMS).
- Subscribers shall be able to send and receive text via the IMS to/from several types of networks (within IMS, GSM/SMS, PSTN/GTT etc.)
- It shall be possible to switch between real time and non real time IMS text communication without major user actions. As an example, after a reply to a text message has been received, the users may decide to continue the text communication in real time.
- Text can be one of the components in a multimedia call, but also, text can be the only communication component in a session (e.g. when conversational text medium is used).

## Videophone Service

- Subscribers shall be able to make and receive conversational class videophone calls if the user devices can support the video component, compatible codecs, and all networks used by the call, end to end, are capable of supporting it.
- It shall be possible to initiate the full videophone call at initial set-up, or the video component may be added to an existing voice call and removed, as the user requires.
- Capability shall be provided to initiate a session with audio only, video only or both. If a call is made to a network that cannot accept video (eg PSTN or GSM), then the call should default to voice only.
- Information provided during the call shall be the same as for Basic Voice Service. Additional messages may be given by video.
- Call redirection and barring capability as for Basic Voice Service.
- Additionally, the user can redirect and bar the audio and video components separately.
- The network operator should also have the capability to redirect and bar the components separately
- The user can set up calls to multiple destinations (multi-party call) as for Basic Voice Service. The user should be able to display the video from each party in the call either in turn or simultaneously (if the terminal is capable).
- The user already busy on a call or session can be alerted to another incoming call and can choose to accept it (suspending the session, putting original call on hold) or reject it as for Basic Voice Service.
- The user should be able to switch the audio or video components of the call on and off during the call as required.



- The user can be charged for calls in the same ways as described for Basic Voice Service. Additionally, separate charges can be raised for the audio and video parts of the call.
- When interworking with other networks that can carry video, the switching on and off of the video component of the call should be recognised by all networks. Similarly for the switching on and off of the audio component.
- Additionally, when the audio or video component is switched on or off during a call, the network should adjust the resource required (particularly the radio resource).

## Mixed Media Interactive Communication

Note: Mixed media communication capability enables the upstream and downstream communication paths to consist of different types of interactive media.

- For the support of mixed media communications, the subscriber shall be given the opportunity to select the type of communication when an incoming call is received (how to answer incoming calls, e.g., “*normal voice call*”, “*receive audio and reply text*”).
- For the support of mixed media communications, , when a subscriber initiates a session, the subscriber shall be able to select the type of communication desired (e.g., “*normal voice call*”, “*send text and receive audio*”).
- Activation of Mixed Media Interactive Communication services would typically occur on a per communication session basis. For each communications session initiated or received, the subscriber would indicate if the call should be established as a normal call or as a type of mix media interactive communications call.

Note: Since activation would typically occur on a per communication sessions basis, de-activation would automatically occur at the termination of the current communication session.

- Applications may need to be loaded into the subscriber’s terminal equipment to support the Mixed Media Interactive Communication services. These applications could be loaded over the air interface at time of subscription. Network operator software distribution capabilities could be utilized to distribute revised versions of these applications to the subscriber’s terminal equipment.
- Calls utilizing the Mixed Media Interactive Communication service could be charged voice calls, data calls, or a combination of both. These charges could be based a variety of factors including the following:
  - Duration of the call
  - Amount of data services used for the call (e.g., number of packets)
  - Destination of called party including location of called party
  - Location of subscriber
  - Level of QoS used for each media type
  - Amount of bandwidth used for each media type

Note: The text component of a mixed media interactive session can be provided as real time conversational text as described in the GTT-IP service.

- The capabilities of the mixed media interactive communication service should be available in the roamed-to network in the same manner as in the home network; within the limitation of the capabilities of the serving network.
- Capability shall be provided for network and user equipment to support upstream and downstream communication paths for one communication session with different media types.
- Capability shall be provided to “answer” an incoming call with an indication of the desired upstream media type.
- Capability shall be provided to initiate a communication session with specification of the media types for both the upstream and downstream communication paths.

## Multimedia Based Voice Response Unit

- For multimedia based voice response unit support, the capability to change media type (including QoS and bandwidth characteristics) of an active communication sessions without having to establish new separate communication sessions shall be provided.

## Emergency Call

### General Description

It is a regulatory requirement in many countries that networks offering speech service shall also offer emergency speech service. For detailed 3GPP requirements see TS 22.101.

In some countries e.g. the USA the regulator also requires that in case of an emergency call also the geographical location of the handset is signalled to the emergency centre.

In some regions, also emergency text conversational service is required.

### Requirements

- Emergency calls shall be supported with and without USIM depending on the requirement of the regulator.
- Emergency service requires a connection from terminal to emergency service centre.
- Emergency service requires a specific handling regarding priority and set-up delay.
- The routing shall be able to take into account the area where the call is made in order to route call to nearest emergency call centre.
- Emergency call centre is required to receive additional details like Calling Line Identity (e.g. for call back purpose) as call arrives.
- Due to special nature of emergency call some specific service control / management logic may not apply e.g. CLIR shall not apply.
- Emergency call shall be available in each country according to local regulations and usable for local subscribers and roamers on same way.
- Further, a subscriber shall be able to establish emergency call with a familiar number.

For more detailed 3GPP requirements see TS 22.101.

## Mobile Number Portability

### General Description

Mobile Number Portability (MNP) is defined as the process enabling a mobile subscriber to move from a network operator to another network operator without changing his mobile number. The change of network operator may or may not imply a change of service provider.

MNP only allows a customer to change network operator or service provider while keeping the same mobile number for the provision of the same basic service.

For more detail see TS 22.066.

### Key Requirements

- MNP is only applicable to E.164 numbers.
- IMSI are not portable.
- MNP must not preclude the provision of supplementary services, including services offered not in conjunction with a call
- Implementation of Number Portability at national level entails potentially significant changes to numbering administration, network element signalling, call routing and processing, billing, service management, and other functions.

For more detail see TS 22.066.

## Identification Restriction

### General Description

Sometimes, when using telecommunications services, a user may want to protect their privacy by not revealing their identity to any other parties. In addition to the user preferences also regulatory requirements exist in some regions to protect the identity of the calling party.

For more detail see TS 22.081.

### Key Requirements

- The user shall have the possibility to protect her identity on a per call basis or permanently.
- Once invoked, the restriction services are in force for the entire duration of the call or multimedia session.
- It must be possible for the anonymous user to participate in a multimedia session and to restrict the presentation of their identity
- The network must store the user's anonymity preferences in the user profile.
- The network must check to determine if the user has invoked the presentation restriction service prior to initiating a call or multimedia session.
- The terminating network shall be able to distinguish between the case that the identity of the originator is not available (e.g. deleted by the transit network) or restricted by the originator
- The user may be charged on a "per usage" basis or the user may be charged a flat rate for the duration of the regular billing period
- The network shall support an Override Capability that allows authorized parties to override the Calling and Connected Party Anonymity services.

For more detail see TS 22.081.

## Lawful Interception

### General Description

Regulatory requirements exist in some regions to provide lawful interception capability.

If a mobile target (the subject of the interception) is identified by the Law Enforcement Agency (LEA) a so-called "Intercept Request" is transmitted from the LEA to the Administration Function of the network operator specifying the identity of the target. The LEA must also specify the scope of the interception, including which types of media are to be intercepted, the duration of the interception. The Administration Function invokes the intercept function in one or more nodes in the network. Once the intercept is invoked, all appropriate media sessions shall be intercepted and delivered to the LEA via the Delivery Function.

For more detail see TS 33.106.

### Key Requirements

- It is essential that the target not be aware of the intercept, i.e. that the interception shall occur in such a manner that no indication is given to the target that the interception is occurring
- It must be possible to intercept any type of session involving the target. The session may contain one or more media components. The media components may include voice, text, video, real-time data communication, or other supported media.
- The intercepted communication may be analysed or recorded for use in law enforcement.
- The network operator shall be able to deliver two types of information to the LEA: Content of Communications (CC) and Intercept Related Information (IRI).
- An authorised LEA can invoke, modify, or terminate an intercept session at any time.
- Availability of the lawful intercept capability depends on the local regulations and policies.
- The availability of lawful intercept shall not affect the telecommunications services which are available to the target subscriber.

For more detail see TS 33.106.

## Malicious Call Trace

### General Description

Malicious Call Trace is a facility invoked by the user to record all the events and services invoked by a calling party when the user deems the call to be threatening, malicious, life threatening or of use to law enforcement agencies. Invoking the trace instructs the network to alert the operator. The network should be also capable of informing Law Enforcement of the proceeding call, and allow LEA to monitor a call in progress.

### Key Requirements

- The network should be able to track (keep a record, statistics) trace related activities on its subscribers in order to warn, or terminate services.
- The network should be able to resolve originating IP address and ports, and be able to bar access from those ports, or IP addresses.
- The network should be able receive trace requests from other networks. It need not divulge that information to the requesting network, but may act on it's own, or forward to LEA.
- The user shall be able to invoke even in case of roaming.

## Global Text and Total Conversation

### General Description

Global Text and Total conversation (GTT) introduces **real time character by character** text conversation as a component in Basic Multimedia conversational services. It can be used alone or in combination with other media. Of special interest is to combine conversational text with video and voice, forming the service that is called Total Conversation in ITU-T F.703 Multimedia Conversational Service Description.

This is a simple example of how a user interface for Total Conversation may be composed.



Figure: Example of Total conversation user interface during a session.

One important reason to offer the Global Text and Total conversation feature is to enable emergency service access to people who are depending on a written dialogue.

By having the three media available simultaneously during the session, the user can easily mix and match:

- talking in the voice channel
- checking reactions, adding feelings, showing objects and using sign language and lip reading in the video channel
- typing information in the text channel for immediate reading word by word in the same rate as they are entered.

The text part of the dialogue can vary between some items requiring exactness, such as an e-mail address or a booking number, to typing the whole contents of the conversation.

The text part is also valuable when at least one of the users is in a noisy location or in a place where it is not acceptable to speak loud, as in meetings.

The text medium is important for many people who cannot use the voice channel fully.

- It is essential for deaf, hard-of-hearing, deaf-blind and speech-impaired people to have the opportunity to perform a typed conversation in real time. The opportunity to combine and use the media that are most suitable for the moment creates the good usability and can attract large user groups to GTT.

- In a conversation between a hearing person and a deaf person, the users would likely decide to mainly use the text channel, while the video medium is valuable for recognition and adding the feeling of contact.
- Many elderly people experience a gradual loss of hearing while the capability to speak remains. With Total Conversation the use of telecommunication for conversation can be maintained in a smooth way. Use of speech can be maintained as far as the words are perceived. Seeing the counterpart gives support for lip-reading in combination with hearing. When hearing and lip-reading fails, the counterpart can fill in with typing single words or the whole conversation according to the need. This offers an excellent opportunity to manage a conversation never before offered by telecom services.

Total Conversation attracts many users who have hereto been left without telecom services at a suitable functional level. There may be as much as 3 % of any population who have limited use of voice based services.

GTT as described in the Stage 1 specification 3GPP TS 22.226, can be provided through three transmission channel types: CS Voice, CS Multimedia and IP Multimedia. The scope of this report is IP Multimedia based services. Therefore only the features and requirements for the IP based GTT-IP are described here. It is part of the Basic Multimedia Conversational services.

Interoperation with Multimedia Messaging Services is within scope of this feature. This interoperation is in terms of using the same user interface devices and providing convenient ways to go back and forth between the two services for interaction with the same user as the requirement for real time handling versus message storing varies.

Further details pertaining to GTT are provided in TS 22.226.

### Key Requirements

- GTT-IP shall enable text conversation to be included in Basic Multimedia conversational service.
- Users of the GTT-IP Service shall be able to add and use a real time, character by character text stream during a session.
- Initiation of sessions and the text component shall be done as for the Basic Multimedia Conversation service.
- It shall be possible to activate only the text medium.
- It shall be possible to initiate the full Total Conversation session at initial session initiation. It shall also be possible to add the text component to an existing session with voice and video as the user requires.
- It shall be possible to open the text component in the session with no or very few user interface actions.
- All session progress information shall be given in visual form since the service is expected to attract hearing impaired and deaf users.
- The text received during the session shall be displayed to the user as it is received. The text coding conventions for Total Conversation shall be applied as specified in 3GPP TS 26.235.
- The video component shall meet some minimum requirements when it is used for lip-reading or sign language in Total Conversation situations. These requirements are documented in ITU-T H-series supplement 1.
- Interworking with existing text telephony in PSTN as well as emerging forms of standardised text conversation in other networks is within the scope of Global Text and Total conversation. Such interworking may be a regional regulatory requirement if corresponding interworking is provided between IP Multimedia based voice conversation and voice telephony in the other network.
- It is valuable to offer well specified external interfaces for the media components and control. Thereby people who need special forms of display or control can use mainstream terminals and attach user interface devices for their needs.
- This is for example true for deaf-blind users, who usually need a special tactile user interface that needs standardised specified external interfaces
- If a session is made to a terminal that cannot accept text, then the session should use the accepted media streams and indicate to the user that text medium communication was not possible.
- It shall be possible to offer interactive text communication capability without specific user registration to the service.
- Interworking shall be provided between domains (CS/PS/IMS) enabling users of interactive text communication across diverse networks, including those external to 3GPP systems.

## **Mobile Virtual Private Network**

### **General Description**

A Mobile Virtual Private Network (MVPN) offers secure single sign-on access to the company's information management systems, including access to filed documents, video clips (e.g. process descriptions) and real time transaction information, while mobile; optional ability to retrieve information while talking to company employees; and access to relevant information exactly when needed.

### **Key Requirements**

- The possibility to set up a single session with the corporate environment and later use it for single or multiple media components synchronised if of value shall be offered.
- It is required that a single authentication and authorisation enables access to the full capabilities of the corporate environment.
- It must be possible to address the corporate gateway using its E.164 or URL address.
- The corporate customer shall, as a minimum be able to activate and deactivate a known user's access to the service.
- It shall be possible to adopt the security of the access to the security of the customer's corporate environment
- It shall be possible to set-up a secure bit pipe to company Intranet gateway, allowing multiple simultaneous media components of various QoS.

## **Local Services**

### **General Description**

In addition to the services provided by the Home Environment (home services) the user shall have also the possibility to access so-called local services. Local services are services that are provided by the current serving network (home or visited).

### **Key Requirements**

- The user shall have the possibility to access the local services.
  
- The user may have the possibility to discovery the available local services (Note that there is no requirement to standardise this functionality identified yet).



## 1.2 Presence Service

### General Description

The presence service provides access to presence information to be made available to other users or services. Exploitation of this service will enable the creation of wireless-enhanced rich multimedia services (e.g. new communication services, information services) along the lines of those currently present in the Internet world.

A presence-enabled service as observed by the user is a service in which the user can control the dissemination of his presence information to other users and services, and also be able to explicitly identify specifically which other users and services to which he provides presence status. Combined with the capability of other users' control of their own presence status, virtually infinite combinations of users and services interacting at different levels can be created.

For details see TS 22.141.

### Key Requirements

- The presence service shall provide the ability for the home environment and for the users to manage the presence information of users' devices, services and service media, even when roaming.
- The home environment as well as the users shall be able to be both the supplier of presence information (i.e. presentities), as well as the requesters of presence information (i.e. watchers)
- Presence information for presentities shall be made available in a standardised format to enable interoperability.
- The presentities as well as of the watchers shall uniquely identified.
- It shall be possible to use the presence service independent of the bearer or transport mechanism.
- The operation of Presence Service may be offered both in parallel and independent of other services, e.g. supplementary services, tele-services, bearer services or any other services.
- The privacy aspect of presence information and the need for authorisation before providing presence information shall be configurable by the user (i.e. presentity).
- It shall be possible for the user (i.e. presentity) to define different user groups with different levels of authorisation, e.g. the details of presence information may depend on target user groups (e.g. family, friends, colleagues etc.).

For more details see TS 22.141.

## **1.3 Instant Messaging**

### **General Description**

Instant messaging (IM) is defined as the exchange of content between a set of participants in real time. Generally, the content is short textual messages, although that need not be the case. Generally, the messages that are exchanged are not stored, but this also need not be the case. IM differs from email in common usage in that instant messages are usually grouped together into brief live conversations, consisting of numerous small messages sent back and forth.

Instant Messaging could be used as a service coupled with presence and buddy lists; that is, when a friend comes online, a user can be made aware of this and has the option of sending the friend an instant message.

### **Requirements**

- The user shall have the possibility to send and receive a message (instant message) in real time.

## **1.4 Gaming**

### **1.4.1 General Description**

To be provided.

### **1.4.2 Requirements**

To be provided.

## 1.5 Prepaid Service

### General Description

The PrePaid Service (PPS) allows subscribers to set-up phone calls without a long-term contract with the mobile network operator. The subscribers pay in advance a predefined amount of money only. The account of the PPS subscriber is permanently monitored and decreased during a call using on-line charging functionality. If a pre-defined account threshold is reached during the call, the customer could be notified and the call is released. The subscriber can interrogate the balance of his current account at any time. Recharging of subscribers account could be done via different ways (e.g. voucher recharging, credit card recharging, automatic periodic recharging, manual recharging).

### Key Requirements

- The network shall have the possibility to monitor the prepaid account of the subscriber permanently.
- The network shall be informed about any chargeable activity from the subscriber
- The service shall provide the possibility to the subscribers recharge the account

## 1.6 Interactive Customer Care Services

### 1.6.1 General Description

A user is having difficulty with her phone MMI and something is not working properly. The user calls Customer Services. The Customer Services representative is able to scan the current UE settings, given permission by the user. The Customer Services representative is able to determine that the user has changed the ringtone volume to zero. The Customer Services representative is able to increase the ringtone volume, without needing a tailored system for specific manufacturers or models of UE.

### 1.6.2 Key Requirements

To be provided.

## Multimedia group call, multimedia broadcast call

### 1.6.3 General Description

To be provided.

### 1.6.4 Key Requirements

To be provided.

## Priority Service

The following subsections provide a general description and requirements for Priority Service. A more detailed description of the service is provided in Annex C: Background Information.

### General Description

When supporting their national security/emergency preparedness (NS/EP) mission, the Priority Service subscribers receive priority over other subscribers in the establishment and completion of a voice call or a data (multimedia) session. Should a service disruption occur, NS/EP voice and data services should be capable of being re-provisioned, repaired, or restored to required service levels on a priority basis.

The system must be able to identify NS/EP Priority Service subscribers and set a priority indicator to identify or mark the priority traffic (voice calls or data/multimedia sessions). There must be procedures and processes to handle priority service traffic that maintains the end QoS to support the communication. The types of processes required for priority service include priority access, priority call set up or session establishment, priority termination, and exemption from restrictive management controls.

### 1.6.5 Key Requirements

- Priority Service subscribers shall receive priority over other 3G subscribers in the establishment and completion of a voice call or a data (multimedia) session.
- Should a service disruption occur, NS/EP voice and data services must be capable of being re-provisioned, repaired, or restored to required service levels on a priority basis.
- Users can invoke this service either as a permanent subscription or on a per-call/per-session basis.
- Access can be via the use of a special code/dialing sequence/URL and/or a Personal Identification Number (PIN).
- The user can be charged for sessions in a variety of ways including the following methods:

- a) By the duration of the call or session (including “one-off” charge/flat rate). This includes the possibility to charge only for “session connected” time (as opposed to including the call/session set up time)
  - b) By the location of originating party
  - c) By the destination of call (including location of called party)
  - d) By the amount of services used for the call/session
  - e) By the amount of bandwidth used for different media types
  - f) By the level of QoS used for each media type
- When interworking with legacy networks, the capability to transfer and/or translate priority identification is required.
  - Voice and data services must interconnect and interoperate with other government or private facilities, systems, and networks.
  - Priority service must be available network-wide with access to and egress from international service.
  - Security features include the traditional confidentiality, authentication, integrity, availability, and accountability.
  - Priority service users may be given service regardless of user location or deployment status. Means by which this may be accomplished include “follow me”, functional numbering, call forwarding, or functional directories.
  - Selected users must be able to use priority services without risk of usage being traced (i.e., without risk of user identification or location being compromised).

Note: Requirements for Priority Service will be reviewed and may change upon completion of SA1 work on Priority Services.

## **Distributed Speech Recognition Based Voice Portal Service**

### **1.6.6 General Description**

To be provided.

### **1.6.7 Key Requirements**

To be provided.

## **1.7 Location Services**

### **General Description**

Location Services may be considered as a network provided enabling technology consisting of standardized service capabilities which enable the provision of location based applications.

A brief high level overview of Location Services is provided in the annex D: Background Information.

Detailed descriptions of services, including Public Safety Services, Location Based Charging, Tracking Services, Traffic Monitoring, Enhanced Call Routing, Location Based Information Services, and Network Enhancing Services are provided in 3GPP 22.071.

### **Key Requirements**

The following requirements should be validated within the IMS.

#### **Location Information**

- It shall be possible to identify and report in a standard format (e.g. geographical co-ordinates) the current location of the user’s terminal and to make the information available to the user, ME, network operator, service provider, value added service providers and for PLMN internal operations.
- It shall be possible for applications to specify or negotiate horizontal and vertical accuracy.
- Accuracy may be independently considered with respect to horizontal and vertical positioning estimates
- Location Services may allow an LCS Client to request or negotiate the provision of velocity.

#### **QoS Parameters**

- Accuracy is a negotiable QoS parameter.

- The LCS Server may allow a LCS Client to specify or negotiate the required response time (in the context of immediate location request) either at provisioning or when the request is made.
- The network shall provide statistical reporting of reliability (QoS parameters) data.

### Location Requests

- The LCS Server may allow different location requests to be assigned different levels of priority.

### Positioning Methods

- Multiple positioning methods should be supported in the different Access Networks, including both handset and network based approaches (e.g. UL-TOA, E-OTD, IPDL-OTDOA, Network Assisted GPS and methods using cell site or sector information and Timing Advance or RoundTrip Time measurements).
- The location determining process should be able to combine diverse positioning techniques and local knowledge when considering quality of service parameters to provide an optimal positioning request response.
- Both “active” and “idle” UEs shall be capable of being positioned.
- For Emergency Services (where required by local regulatory requirements), the PLMN shall support positioning for unauthorized MSs (i.e. including stolen MSs and MSs without a SIM/USIM).

### Privacy

- Unless required by local regulatory requirements, or overridden by the target MS User, the target MS may be positioned only if allowed in the MS subscription profile. In general, for valued added location services, the target MS being positioned should be afforded the maximum possible privacy, and should not be positioned unless the positioning attempt is explicitly authorized. In the absence of specific permission to position the target MS, the target MS should not be positioned.
- The Target MS Subscriber shall be able to restrict access to the Location Information (permanently or on a per attempt basis). The LCS Client access shall be restricted unless otherwise stated in the Target MS Subscription Profile. The home network shall have the capability of defining the default circumstances in which the Target MS’s Location Information is allowed to be provided - as required by various administrations and/or network requirements.
- It may also be possible for a target MS to authorize positioning attempts after the target MS is notified of a positioning request and the target MS grants permission for positioning. This notification condition (notification with privacy verification) shall be specified in the Target MS Subscription Profile.
- It shall be possible to provide multiple layers of permissions to comply with local, national, and regional privacy requirements.
- For Emergency Services and Lawful Interception Services (where required by local regulatory requirements) Target MSs may be positioned regardless of the privacy attribute value of the subscriber associated with the Target MS (or ME) making the call.

### Security

- The user shall be able to change the setting of the Privacy exception list at any time.
- Specific local, national, and regional security regulations must be complied with.
- Position information shall be safeguarded in a secure and reliable manner, such that the location information is neither lost, corrupted, nor made available to any unauthorized third party.
- Audit records should be maintained of positioning requests and responses to facilitate resolution of security violations.

## Charging and Billing

- To support transaction based charging where applicable, service associated call detail records may need to include (as a minimum) the following additional information (depending on the specific service):
  - Type and Identity of the LCS Client;
  - Identity of the target MS;
  - Results (e.g. success/failure, method used, position, response time, accuracy)
  - Time Stamp;
  - Type of coordinate system used.

## 1.8 Home Monitoring

### 1.8.1 General Description

So far, there has not been an easy way to generate revenue performing remote monitoring with streaming video. But this issue is over come with the home monitoring application. The person in this scenario is actually able to respond to an automated alarm and initiate a video call to remote cameras. The person could be an individual working for a home security company or an individual home owner. This service will use the new capabilities of a multimedia enabled mobile network for delivery of remote control services to a mobile user with video-streaming information. Any presented object can include a picture, video transmission, web page or a user agent. This includes the capability to set up events that trigger remote monitoring, establish video streams and allow remote object manipulation. Another motivation is to allow both multimedia and remote control data services on one common platform, which results in a more simplified system.

It is assumed that the Home monitor has the functions of video camera activation, control and alarming. Also, the home monitor has built-in security and password capability. The Home Monitor Server uses a Generic Video Conferencing Server to provide basic video conferencing functionality. Alternatively the home monitoring server may provide the conferencing functionality. It is assumed that both servers have registered with the network to use the Networks Billing service.

### 1.8.2 Key Requirements

- Provide confirmed alarm service to mobile users.
- Enable users defined procedures to be activated when failing to deliver an alarm.
- The alarm service may override over services such as busy, divert and call forwarding for lower priority alerts.
- Common, default video codecs shall be supported to ensure end-to-end compatibility.
- Allow sessions to be set up using E.164 or SIP URL identifiers. A translation facility may be required between E.164 numbers and SIP URL identities. This may necessitate the provision of ENUM/DNS type facilities. It should be possible to associate a user assigned nickname with an E.164 or URL identity.
- Create a session containing a unidirectional streaming video media component.
- Terminate a session.
- Negotiate capabilities of the terminal, at session set up and at modifications (e.g. video Codec negotiation).
- The user can set up calls to multiple destinations (multi-party). (Note: feasible implementations may imply network-based solutions).
- A user can switch between different video sources.
- Support charging and billing of the originating or terminating entity, pre-paid and post-paid capability, by network operator or by service provider.

## 1.9 White Board Communication

### 1.9.1 General Description

So far, there has not been an easy way to electronically communicate via free format communication-. But this drawback is over come with the white board application. The person in this scenario is actually handwriting a message when a friend initiates a video call to him. This way of creating a message in a native language including symbols and pictures makes the communication more personal than a regular e-mail whether in Chinese, Japanese, English, French or any language.

It is assumed that the end users make use of a “Whiteboard Server” to allow for more than 2 users to share the same whiteboard.

The Whiteboard Server employs a Generic Conferencing Server providing basic conferencing functionality.

Alternatively the Whiteboard Server may internally provide the conferencing functionality.

It is assumed that the Whiteboard Server and Conferencing Server have registered with the network to use the Networks Billing service.

It is assumed that the generic conferencing server is provided by the network operator (could be home, visited or third party) and this handles the bearer level transfer of data between a whiteboard object and the users. A third party service provider provides the whiteboard application and this deals with the application level signalling and control of the whiteboard data.

Also UE1 and UE2 may be located in their home networks or may be roaming or may be roaming.

### 1.9.2 Key Requirements

- Common, default codecs shall be supported to ensure end-to-end compatibility.
- Create a session containing a data session as well as video session if required.
- Terminate any of the sessions.
- Negotiate capabilities of the terminal, at session set up and at modifications (e.g. Java applets).
- Join an ongoing session.
- Provide the ability to bill usage of media components based upon connection time, data volume, application events, personalization, etc.
- Support charging and billing of the originating or terminating entity, pre-paid and post-paid capability, by network operator or by service provider.
- The user can temporarily suspend the session (i.e. put the call on hold).
- If the user is already busy on a call or in other session he can be alerted to another incoming call and can choose to accept it or reject it.
- The user should be able to display a 'whiteboard' object and update as required.

## Systems Engineering Considerations

End to end systems engineering considerations are provided in this section.

### IP Multimedia Core Network

The following general description and requirements are based on the content of TR 22.228. For more detailed information please refer to TS 22.228.

Note: the solutions that are provided for these requirements need to also meet requirements for provision of a full end to end solution including charging and billing, security, privacy, and authorization.

#### General Description

IP has opened up a whole range of communication applications, which may allow service providers to develop totally new value added applications as well as to enhance their existing solutions. The open architecture and platforms supported by IP and operating systems may lead to applications and new opportunities that are more difficult to replicate using a standard switched centralised solution.

A complete solution for the support of IP multimedia applications (including voice communications) shall be available. The solution consists of terminals, GERAN or UTRAN radio access networks and GPRS evolved core network. One of the main objectives for 3GPP specifications is to ensure that the availability and behaviour of these IP applications when used via the 3GPP mobile access is at least as good as when used via other mobile access types.

#### Key Requirements

### High Level Requirements

The following high level requirements shall be supported for IP multimedia applications:

- Negotiable QoS for individual media components in an IP multimedia session both at the time of establishing a media component as well as when the media component is active by the operator and the user
- End to end QoS for voice at least as good as that achieved by the circuit-switched (e.g. AMR codec based) wireless systems shall be enabled
- Support of roaming, negotiation between operators for QoS and for Service Capabilities is required. Such negotiation should be automated rather than manual, e.g., when another operator adds new service capabilities.
- The possibility for IP multimedia applications to be provided without a reduction in privacy, security, or authentication compared to corresponding GPRS and circuit switched services
- Support for interworking between the packet and circuit switched services, and with PSTN, ISDN and Internet.
- Support for basic voice calls between IMS users and users in CS domain/PSTN-style networks, In R5, the boundary interworking shall be able to convey the information associated with the services listed below:

CLIP/CLIR;  
Call Forwarding.

Also due to regulatory reasons the subscriber identity may be required to be conveyed via the IMS-CS/PSTN boundary to enable calling line identification services on both sides.

- Access independence shall be supported. It is desirable that an operator should be able to offer services to their subscribers regardless of how they obtain an IP connection (e.g. GPRS, fixed lines, LAN).
- It shall be possible to limit the view of an operator's network topology to authorised entities.

### Service Capabilities

- Registration mechanisms shall be supported which allow the network to understand the limitations of the mobile and thereby take appropriate actions.

### Capability Negotiation



- The IP multimedia applications shall be able to negotiate their capabilities to identify and select the available media components, QoS etc. of IP multimedia sessions. It shall be possible for the capability negotiation to take place on invocation, acceptance and during an IP multimedia session (e.g. following a change in UE capabilities, change in media types etc.). Capability negotiation may be initiated by the user, operator or an application on behalf of them.

## Redirecting of IP Multimedia Sessions

- It shall be possible for the user or the network to identify an alternative destination for an IP multimedia session or individual media of an IP multimedia session.
- Redirection to alternative destinations may be initiated by the sending party, receiving party or the network on their behalf.
- It shall be possible for redirection to be initiated at various stages of an IP Multimedia session, including:
  - Prior to the set up of an IP Multimedia session
  - During the initial request for an IP Multimedia session
  - During the establishment of an IP Multimedia session
  - While the IP Multimedia session is ongoing
- Redirection can be applied for all Multimedia sessions unconditionally or it can be caused by any of a set list of events or conditions. Typical causes could be:
  - Identity of the caller
  - Location or presence of the calling or called party
  - If the called party is already in a session
  - If the called party is unreachable or unavailable in some other way
  - If the called party does not respond
  - After a specified alerting interval

## Identification of Entities

- IP multimedia communication establishment (both mobile originating and terminating) depending on originator shall be able to be based on E.164 (e.g. +1 23 456 789) or SIP URL (sip:my.name@company.org).

## Customer Care

<< to be provided >>

### 1.10 Telecommunications Management

The operation of IP Multimedia Services is dependent upon the fundamental capabilities of UMTS telecommunications management which include the following:

- Subscription Management to support IMS-related services.
- Configuration, Fault and Performance (including QoS) Management of IMS-related and supporting network resources.
- The definition of charging information to be emitted by IMS-related network resources.

These capabilities will be comprehensively detailed in the 3GPP 32-series Telecommunication Management standards, several of which are identified in the References section of this TR.

## Service Control

<< to be provided >>

## Charging and Billing

Quality of Service (QoS) Based Charging

### General Description

To be provided.

### Key Requirements

To be provided.

## Consistent Delivery of Basic Services

<< to be provided >>

### Capability Discovery and Service Negotiation

<< to be provided >>

## End to End Quality of Service

### General Description

Support is required in telecommunication networks based on 3GPP standards to enable the practical provision and management of inter-domain quality-assured IP services.

As expressed in ITU-T E.800, Quality of Service (QoS) is “the collective effect of service performance which determines the degree of satisfaction of a user of the service”. According to ITU-T I.350, QoS is expressed by parameters, which are independent of the network design, based on user perceivable effects and takes into account all aspects of the service, which can be objectively measured at the service access point.

From the perspective of the end user (customer), Quality of Service may be viewed as an end-to-end concept. The requirements of the end users must be met even when services are offered across several operator’s networks, across different domains (including wireline, wireless, circuit switched, packet switched, and IP based multimedia services), and using different technologies (including different access networks).

### Key Requirements

To accomplish this, the following requirements are identified for validation in 3GPP networks enabled to provide IP based multimedia services.

- A mechanism shall be provided enabling the service provider to be responsible for providing end-to-end QoS to the user (one stop responsibility).
- Support needs to be provided for inter-domain IP QoS management, including
  - Mapping of traffic priorities from domain to domain
  - Admission control of traffic flows depending on the available network resources
  - Network resilience and protection
  - Exchange of accounting records
    - Automated transfer of all IP QoS parameters at the network and network management interfaces for services provided by interconnected and inter-domain environments
- End-to-end IP QoS mechanisms must be applied along the full path between two end users.
- Application level QoS signalling must be enabled as an over-all control mechanism.
- QoS classes should be aligned with global ITU standards.

## Quality of Service Management

### General Description

Successful deployment of IP Based Multimedia Services will require provision of network management capability to determine in an automated and consistent manner which users, applications, or hosts have access to services and resources under different conditions.

A variety of different mechanisms exist which may provide varying degrees of service quality under various conditions for various services. A key requirement for the successful deployment of the envisioned IP based multimedia services is the provision of a framework enabling network administrators to effectively and efficiently manage the delivered quality of service from an end to end perspective across networks.

End-to-end QoS may be specified by Service Level Agreements between domains / network boundaries. To enable QoS management based on Service Level Agreements across domains, consideration must be given to the available bandwidth and QoS classes and how they map across domains, policing and shaping requirements, security mechanisms, reports of service usage, billing information, commercial and financial obligations in case of breach of contract, etc. These must be specified in sufficient detail to enable consistent interpretation (and measurement) from one domain to the next for all domains along the traffic flow.

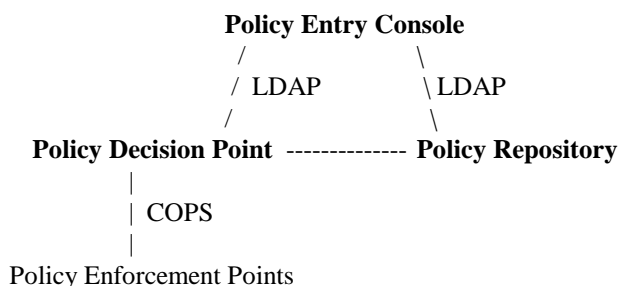

Diagram: Relationships Between QoS Management Entities

## Key Requirements

Quality of service management may be achieved based on Service Level Agreements (SLAs) using policy based network management techniques. This enables QoS policies to be defined, stored in a policy repository, and retrieved to make policy decisions (at Policy Decision Points, PDPs). A centralized platform is therefore required for network administrators to define and distribute network policies to enforcement points throughout the network.

### **Interoperability Between Various Mechanisms**

<< to be provided >>

#### **User Control**

<< to be provided >>

#### **Security**

<< to be provided >>

Integrity

Authentication

Authorization

Privacy

#### **Interworking**

<< to be provided >>

2G / 3G Interworking

<< to be provided >>

1.10.1 GSM / IS-41 Interworking

<< to be provided >>

1.10.2 Interdomain Interworking

<< to be provided >>

#### **Handover**

<< to be provided >>

#### **Roaming**

<< to be provided >>

### **Access Network Considerations**

Different access networks will enable services to varying degrees.

To be further elaborated upon.

<< to be provided >>

### **Conformance Testing**

<< to be provided >>

### **Requirements Cross Reference**

This section will provide information regarding which capabilities and requirements are needed for the provision of which services.

## **Enablers**

<< to be provided >>

## **Toolkits**

<< to be provided >>

## **User Devices**

<< to be provided >>

## **Network Architecture**

<< to be provided >>

## Radio Access Network

### 1.10.3 Core Network

#### Protocols

<< to be provided >>

#### Quality of Service Enablers

##### **IETF Integrated Services (IntServ) and Resource Reservation Protocol (RSVP)**

Intserv provides QoS control on a per application flow level hop-by-hop. With the IntServ/RSVP approach, applications set up an end-to-end path with reserved resources using RSVP. Network resources are reserved on a per-flow basis. Only applications with “real time” requirements use this approach, “best effort” applications share the non-reserved resources and thus do not adversely impact the “real time” applications when their demand for resources increases.

IntServ specifies two service classes. Guaranteed Service provides an assured level of bandwidth, an upper bound on end-to-end delay, and no queuing loss. Controlled-Load Service doesn't provide assured guarantees, but provides a flow similar to that of best-effort on a lightly loaded network, but unlike best effort, doesn't deteriorate when load increases.

To invoke IntServ a router needs to be provided with data flow traffic and reservation characteristics. This information can be provided by RSVP.

RSVP is a receiver oriented protocol for reserving resources. It includes mechanisms for policy control (is the user allowed to do this?), admission control (enough resources available?), QoS enforcement (classification and scheduling) and dynamic route changes (periodic path refreshment).

Concern has been expressed that RSVP does not scale to the size of the Internet. To address this, class-based aggregation and hierarchical RSVP have been introduced. Class-based aggregation enables flows with similar requirements to be grouped together according to different service classes. Within an aggregation area the bandwidth available for a given service class can be specified. Hierarchical RSVP enables large pipes with particular QoS parameters to be reserved across aggregation regions.

##### **Differentiated Services (DiffServ)**

DiffServ differentiates streams at the aggregate level and enables service providers to provide different classes of service to traffic flows that are based on Service Level Agreements (SLAs) between customers and the service provider. Packets are routed in an aggregated manner based on different DiffServ Code Points, which are indicated by a field in the packet header.

DiffServ aggregates traffic as a function of the desired Per-Hop-Behavior (PHB) of packets. The Per-Hop-Behavior for a packet is associated with a DiffServ codepoint (DSCP) by ingress routers. DSCP -> PHB mappings may be different in different domains, and need to be co-ordinated across domains.

##### **Multiprotocol Label Switching (MPLS)**

MPLS is designed to speed up packet routing in the core network by integrating Layer3 routing with Layer2 switching, independent of the underlying link-layer protocol. To do this entry routers assign a label to each packet that defines the packet's hop by hop Label Switched Path (LSP). The egress router then removes the label from the packet as it exits the MPLS domain. This makes the LSP appear as a single hop regardless how many routers are traversed within the network.

##### **Constraint Based Routing**

Constraint based routing determines routes through the network based on multiple constraints, including resource availability (QoS) and policy constraints. Such constraints can include available bandwidth, link and end-to-end path utilization, delay and latency, jitter, reliability, and administrative weight. The optimal route may not be the shortest route when these are taken into consideration

##### **IPv6**

Ipv6 introduces a number of enhancements over IPv4 that can impact QoS. As such it may be viewed as a QoS enabler.

Key enhancements include the provision of a simplified header format, an extension header with options, expanded addressing, enhanced routing, security enhancements, auto-configuration. Although Ipv6 doesn't provide specific QoS mechanisms, new header modifications do provide an enabling mechanism for the provision of QoS. The header changes most directly related to QoS include provision of a Traffic Class and Flow Label.

The Traffic Class is the same as the Type of Service field in IPv4, and can be used to distinguish different classes or priorities of packets.

The Flow Label is a new field intended to enable flow control where a flow is viewed as a sequence of packets from a source to a destination with special handling along the path. The special handling may be conveyed between routers using a control protocol such as RSVP, or by information in the flow's packets (for example, DSCP). The Flow Label is assigned by the source and may then be used by all routers along the path as a data access key to flow related data.

### **Inter-operation Between Approaches**

It may be that no one approach provides an optimal solution for the various IP based multimedia services. Additionally, the various approaches may be viewed as being complementary to one another. As such requirements for inter-operation between the various QoS mechanisms exist.

## **QoS Management Enablers**

### **Service Level Agreements (SLAs)**

In IP Networks, Service Level Agreements (SLAs) provide a mechanism for communicating various types of information across domains and between service providers. SLAs consist of two parts, Service Records and Traffic conditioning agreements. Service Records containing long term agreements pertaining to liabilities, level of customer support provided, network monitoring options, and billing options. Traffic conditioning agreements (TCAs) may change frequently and contain information pertaining to the classification of incoming traffic, bandwidth and QoS profiles, policing and shaping requirements.

For the provision of end-to-end QoS, SLAs must be consistently interpreted from one domain to the next along the entire communications path.

### **QoS Policies**

Policies are rules that describe the actions that should occur when specific conditions exist, and may be related to network usage, configuration, installation, error handling, security, and services. They are represented as data structures that can be stored and retrieved within the network, for example as defined by object classes in the Core Information Model (CIM).

Policies are enforced at Policy Enforcement Points (PEPs) in the network. When a PEP receives a notification or a message that requires a policy decision, the PEP sends a request to a Policy Decision Point (PDP). The PDP compares the current state of the network to the desired state that is described by an application specific policy. and decides what, if any, action is required. The PDP then returns the policy decision to the PEP which acts accordingly.

### **Common Open Policy Service (COPS) protocol**

COPS is a simple request/response protocol between Policy Enforcement Points (PEPs) and Policy Decision Points (PDPs) in the network that provides a way to distribute policy configuration information to devices. COPS uses a client/server model where the PEP sends requests, updates, and deletes to the remote PDP, and the PDP responds with decisions to the PEP. However, additionally, a PDP may push information to a PEP.

COPS does not provide a monitoring capability, and as such does not enable a complete management solution. For monitoring other management protocols are needed, such as SNMP.

### **Simple Network Management Protocol (SNMPv3)**

SNMP was originally specified as a network element operation and performance monitoring protocol that did not provide intrusive management operations. However, as the need for such capability in IP networks has evolved, so has the SNMP protocol. SNMP is the protocol being used by the DiffServ MIB to setup traffic classification filters and queues, monitor the degree to which traffic flows are within their profiles, and take action if needed (traffic shaping, policing, marking).

### **Differentiated Services Policy Information Base**

<< to be provided >>

## Verification

Editor's note: this section will provide an explanation of how the various enablers meet the requirements of IP based multimedia services (as identified in the previous sections).

either

- enough Service Enablers, or
- missing Service Enablers to be identified and S2 informed about the need
- additional aspects to be defined for Service Element n

### Verification Methods

Service Examples, Requirements and Service Enablers

The example of usage of the definitions: Service Examples, Requirements and Service Enablers is depicted in picture below.

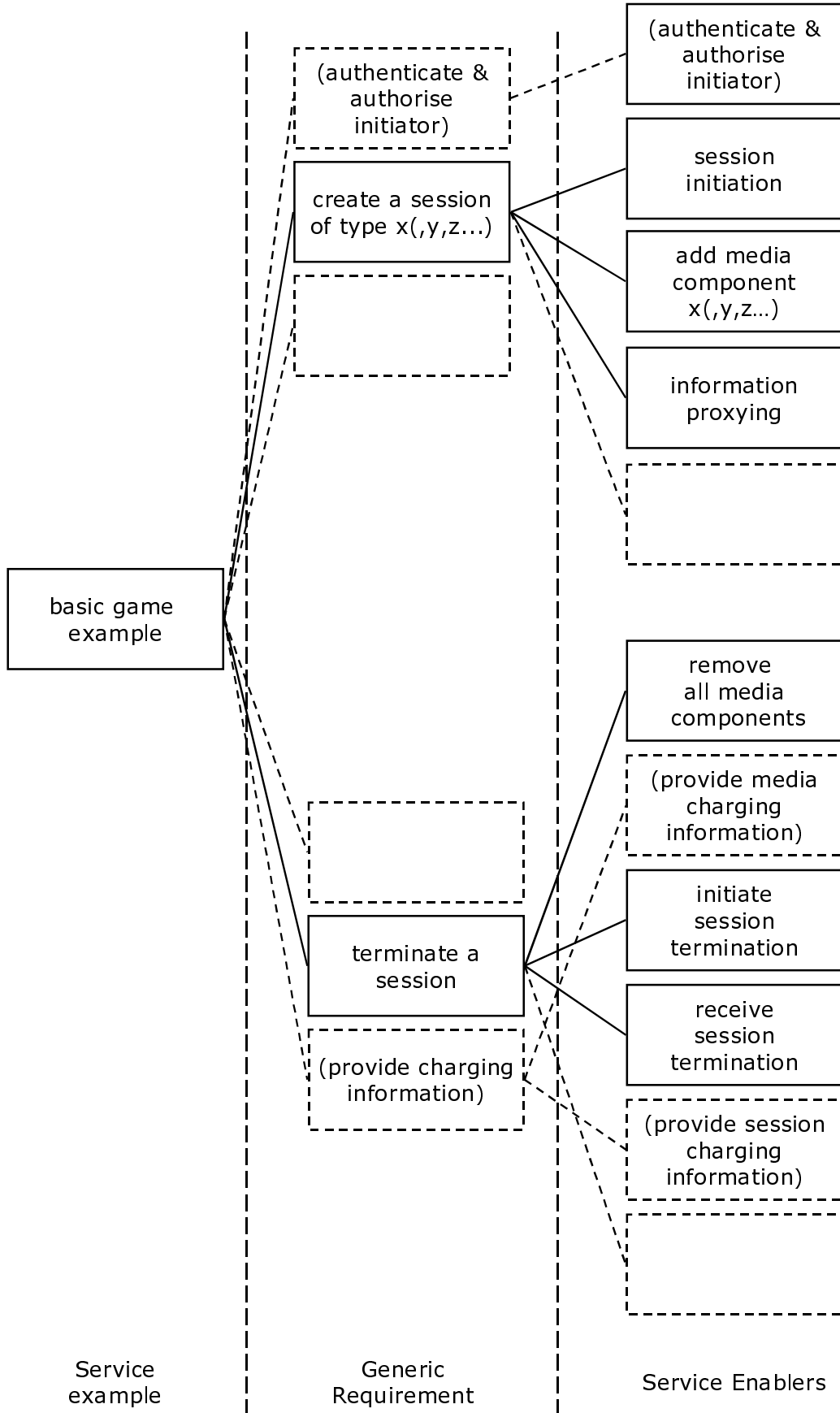
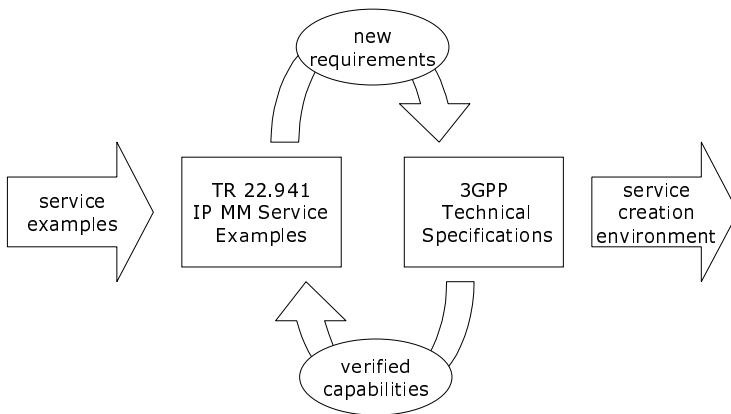

Figure 1: Examples of Requirements and Service Enablers

## Verification of Service Enablers



**Figure 2: Verification of Service Enablers**

The method, used in this TR to ensure definition of complete set of Service Enablers, consists of the following steps:

- generate a sufficient number of service examples
  - basic examples to define a minimum set of Requirements for the time frame when 3GPP R5 based services are brought to market
  - advanced examples to define wish list for the 3GPP R 5 time frame
- verify the relevance and usefulness of these service for the 3GPP R 5 time frame
- break down each service example into sufficiently complete set of Requirements covering
  - service aspects, including usage, initiation, user interface ...
  - charging and billing
  - roaming
  - security
  - interoperability
  - other requirements, e.g. pertinent to service distribution, service marketing etc.
- verify that requirements are covered in 22-series specifications.
- ask SA2 and other relevant groups to develop a list of defined Service Enablers
- jointly with SA2 and other relevant groups, create a matrix to verify that a sufficient number of Service Enablers exists to build the agreed examples
  - if yes => ok
  - if not => request additional Service Enablers
- add more service examples as required to guide definition of additional Service Enablers



## Annex A (informative): Change History

Change history												
TSG SA#	SA Doc.	SA1 Doc	Spec	CR	Rev	Rel	Cat	Subject/Comment	Old	New	Work Item	
			22.941					Rapporteur's initial draft skeleton		0.1.0		
								Addition of Initial Services Examples (S1-010383) from Tempe IMS adhoc meeting		0.2.0		
								Comments from 5/9/01 IMS drafting adhoc, Helsinki		0.2.1		
								Comments from 5/10/01 SA1 plenary, specification -> report, added Instant Messaging		0.2.2		
								Added emailed contributions on: Sections 8.1, 8.2, 8.9 (BT) 7.1 folded in 8 (editor) 8.10 (Nokia) 8.5.1 (Nokia)		0.2.3		
								Added email contribution on: Section 8.8 (Ericsson)		0.2.4		
								Added Comments and contributions from June Dallas Adhoc, including: Section 8.3 (AWS) Section 8.4 (AWS) 8.5.4 Lawful Interception (Rogers Wireless) Calling Party and Connected Party Anonymity (Rogers Wireless)		0.2.5		
								Additional comments provided by Dallas SA1 IMS adhoc drafting session.		0.2.6		
								Final output from Dallas SA1 IMS adhoc + Mobile Number Portability (Rogers Wireless) + additional editorial improvements		0.3.0		
								Output from Lake Tahoe Framework adhoc. Restructuring, refinement of examples, additional examples.		0.4.0		
								Removal of hidden text		0.4.1		
								Output from Dallas SA1 IP Framework Adhoc		0.5.0		
								Output from Loipersdorf IP Framework Adhoc		0.6.0		
								Output from Kobe IP Framework Adhoc's agreements on first day		0.6.1		
								Output from Kobe IP Framework Adhoc		0.7.0		

## Annex B (informative): Additional Service Examples

Editor's note: those examples below that are elaborated upon in the body of the document should be deleted from the appendix. Remaining examples (and further examples) should be retained in the appendix.

Additional examples to be provided for:

- Streaming
- MultiMedia Messaging (including MMS, Push)

Selected representative IP based multimedia services, to be used for validation of requirements and capabilities, are described in the body of this report. It is anticipated that many additional services will be enabled by the capabilities

developed. This appendix provides additional examples of basic and advanced IP based multimedia services for consideration. Note that this list of services is not intended to be exhaustive or complete, but rather only to provide further service examples for consideration.

## 1 Mobile Internet Access

A service that offers mobile subscribers access to full fixed Internet Service Providers. The offered transmission quality and functionality offered by the service shall be near-wireline. Web-casting multi-media to multiple parties.

Examples are:-

### ***MP3 download***

Background download of mp3-files from a remote server with an option to follow the progress of the download by command if the user requires. Per song charge.

MP3-downloads without UE being tied up during the transfer. Downloads are charged per song, including no charge in the case of an unsuccessful transfer.

The network must be able to deliver two or more independent simultaneous media streams to the same UE. The UE has to be able to handle two sessions at the same time. Ability to assign UE resources to either session.

## **Customised Infotainment/Edutainment**

Customised Infotainment is a service which provides device-independent access to personalised content (like advertisements, Information Services, communities, etc. ) anywhere, anytime via structured-access mechanisms which will allow also the support of services like mobile commerce, mobile chatting. (e. interactive entertainment).

Personalised multimedia services.

Examples are:-

### ***Games may be downloaded – need to attract the game development community***

Games may be loaded at point of sale or other outlets

### ***Interactive remote learning***

### ***Multiplayer mobile gaming with voice channel***

Shoot-n-Shout is a team competition where you simply shoot down the members of the competing teams. At a web/WAP service operated by the game application provider, interested potential players can choose a game session and also find other gamers to form a team with. There is a text chat service where potential teammates can learn to know each other. Teams can prepare a game strategy in advance through the text chat service, but when in the battle they need a faster way of communication. There is a conference/chat service where all players can talk (or rather shout) to each other in a "common room" and one "private room" for each team. Players in a team can also dynamically create more "private rooms" if they only like to talk to one (or a few) of their friends. The volume (and stereophonic position) of the players voices when they are using the "common room" is controlled so that it matches the virtual surroundings in the game environment, e.g., players that are behind a wall will only be heard as a vague whisper in the distance.

### ***The Real Virtual Theatre and Foyer Chat room***

A group of people is watching a theatre play and is utterly fascinated by the first act. Bob, a friend of theirs, is in a hospital bed and they really want to share this first act with him since they know Shakespeare's Midsummer Night's Dream is his favourite. Bob uses the theatre's online streaming service via the hospital network, displaying in colour and stereo surround sound on his bedside TV set. In the break his friends call him up from the theatre chat room equipped with 3D sound pick up and local display screens with streaming facilities. They set up the streaming from one of the screens to be synchronised with Bob's bedside equipment. Their voices are also mixed into the sound streams as they talk. Bob now gets both the playbacks from the first act and his friends' voices in 3D-surround sound. Bob's voice is projected close to the screen as if he was standing leaning on the bench right there. His voice is very clear and full of emotions as he speaks to the various playbacks. Both parties can control the playbacks and watch their own selection in a second window on the screen.

## **E-commerce and m-commerce**

Examples are:-

### ***Follow-up of a push service***

A presentation of a push announcement (e.g. based upon the user's location) can be followed up either by a voice call, using a hyperlink included in the announcement, or by an on-line m-commerce transaction. The originator of the push announcement will increase the yield of the campaign by allowing spontaneous purchases or by connecting potential buyers to a sales rep. The receiver of the push can focus on the content of the announcement rather than on how to use it. The push originator must be able to authorise the receiver to make a voice call or to perform an on-line transaction at the cost of the push originator. The push receiver's UE and network connection must be able to handle a voice call or an m-commerce transaction while receiving a push announcement. It must be possible to split charges for the call/transaction as required by the push originator, e.g. to reverse call charges.

### ***In-store personalised shopping***

Matuma is engaged in a mobile call to her mother. She goes into her local shopping mall, on entering the mall she receives information (e.g. pushed advertising information) from the store's web network on special offers (for grocery, hardware etc). Based on the advertisement she can order her goods (whilst discussing them with her mother and letting her see the goods on offer). She pays for the goods via her mobile account, and picks up her goods before leaving the store. Based on her personalised user profile Matuma only receives mall information that is of interest.

### ***Multimedia customer care***

User calls his customer service centre/repair centre to query the contents of an invoice. The invoice is shared between the two parties and modifications made online, and agreed to automatically debit from the customer's mobile services account.

## **Multimedia Messaging Information Service**

Non-realtime, person-to-box type services. These services include real-time multimedia messaging services, instant messaging services (due to the always-on capabilities), messaging services target for closed user groups, specific communities defined by the service provider or the user (e.g. unified messaging).

Examples are:-

The user is idle in a network and not involved in a communication. The user modifies his user profile to divert all voice communications other than those from high priority, pre-identified callers (e.g. his boss). In this scenario all emails and text messages continue to be received regardless of the sender.

### ***Mobile synchronised multimedia messaging container***

Bill is on a business travel to Spain. He calls his wife Christine every night using his terminal. This evening Christine has been at a restaurant with a friend. When Bill is calling, she is sitting on the commuter train on her way home. Today, their talk starts off as a common voice conversation. After a while Bill likes to show Christine the lovely sunset view that he can see from his hotel room, so he takes some snapshots with the built-in camera of his terminal and sends them in real-time mode to Christine. Christine likes to show one of them to their little daughter Linda when she comes home. With a quick gesture on the touchscreen of Christine's terminal, she instantly moves the selected picture from the real-time session window to the "multimedia container" icon. All the contents of the "container" is automatically mirrored between the terminal and her home server. In this way, Christine can easily pick up the picture from her Screenphone at home. If Linda is asleep when Christine comes home, she can wait until tomorrow.

## **Phone to Phone Object Transfer**

User A needs to set up an appointment with User B for a meeting. This meeting is about a particular building project and User B needs to review the plans before the meeting. User A is able to send an appointment request to User B via the network, including an attached object which is the building plans. User B can transfer the appointment and object to their own UE-based calendar.

## **Phonebook Synchronisation**

A user receives an SMS from a colleague saying that their phone number has changed. The user is able to update their local phonebook without needing to write the details down on a piece of paper in the meantime. Their local phonebook is now unsynchronised compared with their "backup" copy in the network. The user is able to initiate synchronisation with the network copy. It shall be possible for network operators and third parties to offer backup of phone data without a need to tailor this to specific manufacturers or models of UE.

## **Peer to Peer Gaming**

- **Motivation**

The gaming scenarios proposed in this section can be viewed to extend today's single user games by using the full capabilities of mobile networks, such as radio access and IMS.

In a basic scenario, two or a few players will organise the game amongst themselves using a peer-to-peer model.

- **High Level Service Description**

A player is presented with a visual representation of the game – this may be simple screens (for e.g. tic-tac-toe) seen on the phone today, or more advanced screens (for e.g. "blue objects"). The content of the display is updated as the game advances.

Players can communicate with each other, using written messages or voice, without suspending the game.

A player can present himself to the other players using an id of his choice.

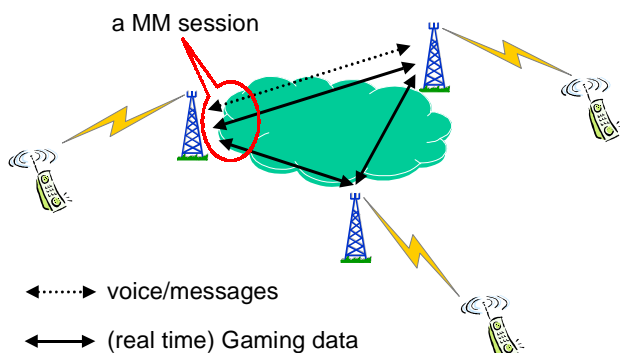

**Figure 3: Basic game setup**

- **Business Model**

The game generates airtime in a PS network.

The players are charged by the network operator for session time and transferred data volume.

- **Relation to IMS**

The IMS enhances the gaming experience by allowing multiple users to contact other users and establish synchronised peer-to-peer sessions as well as by adding and removing voice and/or messaging media components on demand.

- **User Perspective**

A player uses the keyboard and display of a mobile, however if the terminal has additional capabilities, such as colour display or query-keyboard, the game will use these capabilities. The size of the presented playfield is adapted to the size of the mobile's display.

- **Service Specific Considerations**

**Initiation of a game session**

An authenticated and authorised subscriber can either join a game session of his choice or create a new session. Such new session can be set up in a number of ways, e.g.

- by invitation, using id's, names or mobile numbers available in the mobile terminal
- a public session

- a local, geographically limited session

In addition, the subscriber can limit the actual number of players.

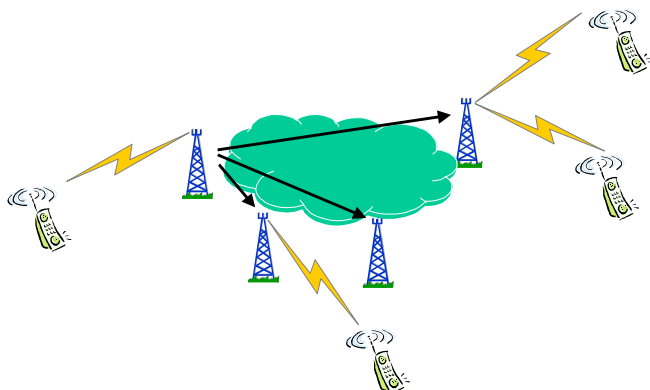

**Figure 4: Parallel invitation**

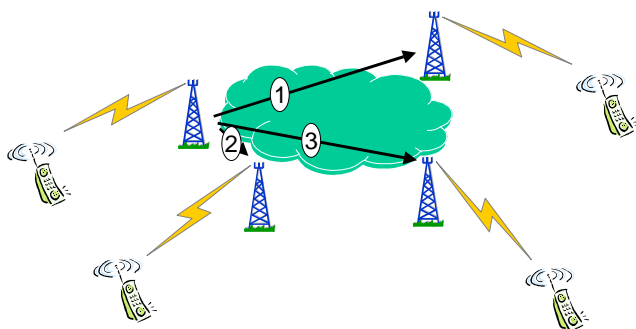

**Figure 5: Sequential invitation**

### Distribution, downloading, terminal capabilities

The application client is either inherent to the mobile terminal, or can be downloaded from a server, provided by the mobile operator.

- **Charging and billing**

The gaming session is charged based in information from the by transferred data volume, and session level information (even though in some cases, the network may not understand the media content as it may be proprietary to the game). The player's charges will be added to his mobile invoice. A player can use a prepaid mobile subscription to cover game charges.

- **Roaming Considerations**

It is possible to participate in the game independent of the actual mobile network, providing that the network offers multimedia capabilities.

- **Requirements**

A mobile network, offering multimedia services, must provide access to a standardised set of Service Enablers.

It must be possible to create a gaming session, which may contain one or more media components, providing connectivity with the other terminal(s). The media components may include real-time data communication for updating the games status; and optional voice or messaging, for communication amongst players.

It must be possible to add and remove the optional media components on demand, with set-up time not affecting the progress of the game ("synchronised media components").

It must be possible to join a game session from a presented list, or – if authorised – initiate a new game session.

Invitations to such new session can be sent to subscribers selected in some fashion, e.g.:

- present in entire network or in desired part of it,
- to entire list at once (parallel initiation) or to individual members one-by-one until a condition (e.g. number of players) is met (sequential initiation)

It must be possible to address presumptive players using their mobile number, their URL or an id of their choice.

At the game session set-up time, the application must check basic capabilities of the terminal (e.g. screen size) and adapt the game presentation accordingly. Some of the capabilities must be re-negotiated at regular intervals, e.g. in case that the radio bearer capacity changes.

The CDR's for each of the media components is collected and rated by the mobile operator. The rating mechanism is based on session and bearer level information, e.g. time and data volume.

The mobile terminal must have the game built-in or be capable of downloading, configuring and setting up the application client.

### Server Based Gaming

- **Example Motivation**

The gaming scenarios proposed in this section can be viewed to extend the previous basic scenario by organisation of the game by a service provider, which might, but does not need to be different from the network operator.

- **High Level Service Description**

A player is presented with video background corresponding to his position on the playfield. The exact position of the player, as well as positions of other players within the same area are also indicated, using individual symbols. During the game players interact with each other, overcome obstacles and are rewarded for reaching higher levels of difficulty.

Players can communicate with each other, using written messages or voice, without suspending the game. A player can present himself to the other players using an id of his choice.

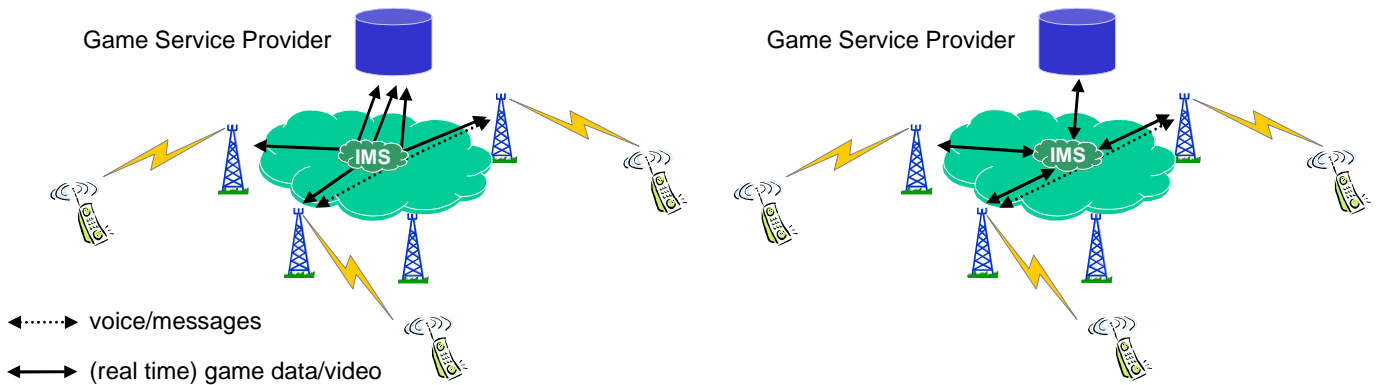

**Figure 6: Alternative advanced scenarios**

### • Relation to IMS

The IMS enhances the gaming experience by allowing multiple synchronised media components as well as by on demand adding and removing extra, e.g. voice and/or messaging media components.

In this advanced example, it is the task of the IMS to allow users to locate and connect to the service provider.

### • Business Model

The game generates airtime in a PS network.

The players are charged by the network operator for session time and transferred data volume and/or charged by the service provider for session time and game events.

### • User Perspective

A player uses by default the keyboard and display of a mobile, however if the terminal has additional capabilities, such as colour display or query-keyboard, the game will use these capabilities. The size of the presented playfield is adapted to the size of the mobile's display.

The player can use his mobile e.g. for answering incoming calls by temporarily suspending the game but without leaving it.

### • Service Specific Considerations

#### Initiation of a game session

An authenticated and authorised subscriber can either join a game session of his choice or create a new session. Such a new session can be set up in a number of ways, e.g.

- by invitation, using id's, names or mobile numbers available in the mobile terminal
- a public session
- a session within a pre-set team
- a local, geographically limited session

In addition, the subscriber can limit the actual number of players.

#### Distribution of the game

To be able to participate in the game, a mobile subscriber connects to a download server and downloads an application client (common for many, if not all types of terminals). A game can therefore be started anytime and anywhere, with a minimum of effort.

As part of the game set-up in the terminal, the client requires authorisation to either use the current mobile account (post- or prepaid) or an account with the game SP (existing or new).

#### Marketing of the game

The game SP can subscribe to the most current information about subscribers of the mobile operator, fulfilling some set of criteria, such as subscription to other games, exceeding a pre-set spending limit or present in certain locations. This allows the SP to efficiently market the game to adequate audience.

A game advertisement will typically consist of a video push stream including a hyperlink. The user can obtain information about the game and set it up in his mobile simply by following the hyperlink.

## Others

It is FFS whether it should be possible to join the game from a non-mobile terminal with multimedia capabilities.

- **Roaming Considerations**

It is possible to participate in the game independent of the actual mobile network, providing that the network offers multimedia capabilities.

- **Charging and Billing**

### Description

The game is charged based on session events (e.g. time) and application level information (e.g. results of the game). The players are rewarded and credited for reaching certain targets. Additional voice or messages are charged at service provider's rate.

The player can choose either to be billed by the game service provider directly or to add the charges to his mobile invoice. Possible game credits are immediately subtracted from the player's mobile account. A player can use a prepaid mobile subscription to cover game charges.

- **Requirements**

A mobile network, offering multimedia services, must provide access to a standardised set of Service Enablers.

It must be possible to create a gaming session, which may contain one or more media components providing connectivity with the other terminal(s) and the game server. The media components may include video, real-time data communication for updating the games status; and optional voice or messaging, for communication amongst players.

It must be possible to add and remove the optional media components on demand, with negligible set-up time ("synchronised media components").

At the game session set-up time, the application must check capabilities of the terminal and adapt the game presentation accordingly. Some of the capabilities must be re-negotiated at regular intervals, e.g. in case that the radio bearer capacity changes.

The game client must be able to seize and release terminal resources (display, keyboard) on demand.

It must be possible to join a session from a presented list, or – if authorised – initiate a new game session. Invitations to such new session can be sent to subscribers selected in some fashion, e.g.:

- present in entire network or in desired part of it,
- to entire list at once or to individual members one-by-one until a condition (e.g. number of players) is met

It must be possible to address presumptive players using their mobile number, their URL or an id of their choice previously registered with the SP.

The CDR's for each of the media components can be collected by the mobile operator. The rating mechanism must be based on bearer level information (e.g. resources requested or usage), session information (e.g. time) and application level information (e.g. game results). In case the SP caters for the billing, an on-line link between the SP and the mobile operators billing system is required.

The mobile terminal must be capable of downloading, configuring and setting up the application client, or as an alternative, to serve as a link to another terminal with such capabilities.

There must be possibility to set up a secure link between the application client and the authorising entity, whether belonging the mobile operator or the service provider.

It must be possible to sort mobile subscribers according to parameters such as Class of Service (CoS), information in the billing system or presence (attachment) in some location. It must be further possible to forward the identity of such subscriber to a service provider through an online link.

It must be possible to set up a push session from a video server (belonging to the SP), include hyperlinks in the push stream and to follow-up the hyperlinks. The hyperlink can originate a data call (download) or a voice call (to a call centre), possibly in parallel with the video stream.

Finally, it must be possible to charge both the push stream and the terminal originated follow-up session (e.g. a client download) to the SP if the SP wants to allow the user to try the game before purchase.

## Multimedia group call, multimedia broadcast call

- **Motivation:**
- **Service description:**

This service is an improvement of the already existing voice group call, voice broadcast call services in the GSM world. The mobile operator would offer it. With this service multimedia information could be broadcasted from a central point, a server, to a professional group (policemen, firemen) or exchanged between the members of the group. Application of such a service could be the transmission of the picture of a suspected person to security forces, and following exchange of information between police agents, or sending of traffic information to a transport company personal.

- **Monetary flow:**

The professional group is charged from the mobile operator.

- **Relation to IMS:**

The IMS enables the transmission of voice enhanced video information to the professional group.

- **Running the multimedia group call:**

**Description:**

During the call, some end users can receive and send multimedia information between each other or from/to a fixed server. Some others may just be able to receive the information.

**Requirements:**

Requires the possibility to build up a multimedia conference between mobile UMTS subscribers or between UMTS subscribers and a server. Requires also the multicast functionality, to subscribers, which cannot take part actively to the conference.

## **Distributed Speech Recognition Based Voice Portal Service**

- **Motivation**

Forecasts show that speech-driven services will play an important role on the 3G market. People want the ability to access information while on the move and the small portable mobile devices that will be used to access this information need improved user interfaces using speech input. At present, however, the complexity of medium and large vocabulary speech recognition systems are beyond the memory and computational resources of such devices.

Distributed Speech Recognition (DSR) overcomes these problems, and it will provide 3G users with a high performance distributed speech interface to server based automatic information and transactional services.

The types of services include those that are voice only, for example, automatic speech access to information, such as a voice portal, described in this section. In the future, a new range of multi-modal applications is also envisaged incorporating different modes of input (e.g. speech, keyboard, pen) and speech and visual output.

- **High Level Service Description**

Subscribers to the Distributed Speech Recognition Based Voice Portal Service will be able to access information and conduct transactions by voice commands using distributed speech recognition (DSR). Example portal services include:

- Information retrieval (e.g., obtaining stock-quotes, checking local weather reports, flight schedules, movie/concert show times and locations)
- Purchase transactions (e.g., buying movie/concert tickets, stock trades)
- Personal Information Manager (PIM) functions (e.g., making/checking appointments, managing contacts list, address book, etc.)

For the sake of brevity, this service will be referred to as 'DSR-based Voice Portal Service' in the rest of this section.

The DSR-based Voice Portal service will be offered by the network operators and will bring value to the network operator by the ability to charge for the voice portal calls. Specifically, the minimum requirements are:

**a) Initiation**

A user initiates a connection to the DSR-based Voice Portal Service, for example, by entering the identity of the portal. The identity used will depend on the scheme of the portal but could include a phone number or even a URL.

**b) Information during the call**

The user speaks to the service and receives output back from the portal as audio (recorded speech or Text-to-Speech Synthesis). While this is the default mode, some terminals could support data feedback that will be displayed on the terminal screen.

**c) Control**

Users can access and move between the various portal services by spoken commands.



Network operators could control access to services based on subscription profile of the callers (e.g., persons should be 18 years or older in order to make purchase transactions.)

## Relation to IMS

This service can be offered over the IMS. The protocols used for the uplink streaming of DSR front-end parameters (from terminal to server) will be based on those in IMS.

## Potential Revenue Streams (Business Model)

The network operator will receive revenue from subscribers directly as well as from the content and service providers who want their sites to be accessible via the voice portal service, and from advertisers. Advertising spots can be inserted at appropriate points during the session (e.g., at the beginning of the session, while the user is waiting for a system response, or at the end of a session).

## User Perspective (User Interface)

The user's interface to this service will be via the terminal equipment. The terminal equipment can have a visual display capability. This will allow the server-based application to display visual information (e.g., stock quote figures, flight gates and times) in addition to audio playback (via recorded speech or text-to-speech synthesis) of the information.

The service provider or network operator will have the option to choose a different DSR codec if supported by the terminal. This may be motivated by the expected noise environment, the service package purchased by the user, or service need. For example, a noise-robust DSR front-end is essential if the user is calling in from a car or other noisy environment, while the baseline DSR front-end might suffice if he is calling from a quiet office.

## Service Specific Considerations

In a DSR architecture, the recogniser front-end (FE) is located in the terminal and is connected over a data network to a remote back-end (BE) recognition server (see Figure 1). The FE transforms digitized speech into a stream of feature vectors. These vectors are then sent as an uplink stream to the BE of a data transport which could be wireless or wireline. The recognition engine of the BE matches the sequence of input feature vectors with references and generates a recognition result. This results in higher recognition accuracy compared to the use of a voice channel by minimising the degradation caused by codec and channel transmission errors. The envisaged DSR-based services also require a conventional downlink stream for audio prompts.

DSR Front-end feature extraction and compression has been standardized by ETSI and an advanced, noise-robust front-end is under development by the ETSI STQ-Aurora DSR working group. DSR applications will be based on the IETF packet protocols using RTP (Real Time Protocol), SDP (Session Description Protocol) and SIP (Session Initiation Protocol). We believe that this is in line with 3GPP TSG- SA4's approach to the development of packet switched services.

- Authorization

Authorization for use of this service will be under the control of the network operator.

- Deauthorization

Deauthorization for use of this service will be under the control of the network operator.

- Registration

Connection to the IMS with terminal equipment containing the requirement capabilities will allow the use of the DSR-based Voice Portal service.

- Deregistration

Disconnection from the IMS will prevent the use of the DSR-based Voice Portal service.

- Activation

As for Basic Voice Service.

- Deactivation

As for Basic Voice Service.

## • Service Provisioning

The DSR-based Voice Portal Service will be able to be provisioned by either the network operator or by a 3rd party service provider.

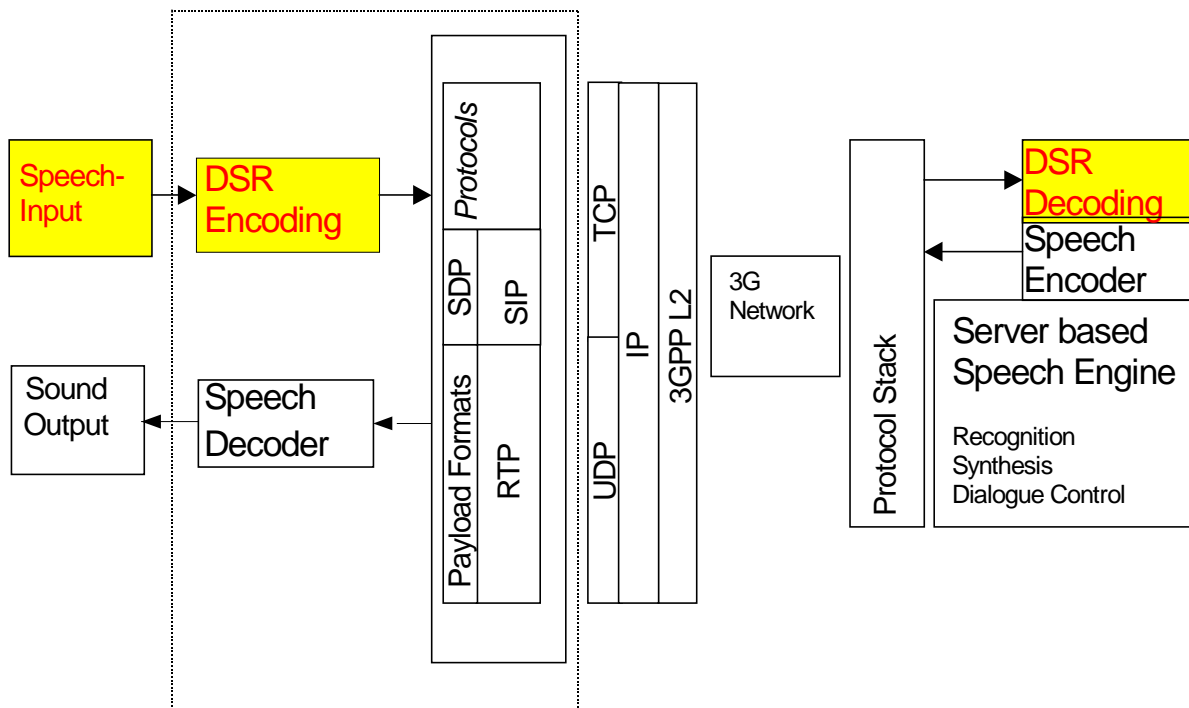

Figure 1: DSR Architecture

## • Distribution, downloading, terminal capabilities...

In addition to the basic capabilities for voice (such as the default voice codec that will be used for the downlink DSR audio prompt stream), the terminal device will require the following DSR-specific capabilities:

- the default DSR front-end (ETSI ES 201 108)
- DSR session control using SIP
- DSR transport using RTP
- The capability to transmit keypad information from the client to the server (e.g., either DTMF or the keypad string)

In addition to the default DSR front-end, the terminal may have additional DSR front-ends that can be selected by the service provider or the network operator, depending on factors such as the noise environment, service package purchased by the user, and the Voice Portal that is being accessed.

## • Charging and Billing

The user can be charged for sessions with the DSR-based Voice Portal Service in a variety of ways. The following should be possible:

- a) By duration of call (including “one-off” charge/flat rate)
- b) By data volume transferred (number of packets)
- c) By subscription fees for the service (unlimited usage or unlimited usage up to a point and then per-use fees)
- d) Free (with the service being subsidised by advertising revenue from advertisement spots)

The advertisement spots can be inserted either at session start-up or close, or designed in such that system delay time is masked (e.g., while the user is waiting for the flight schedules to be returned, or a purchase transaction to be completed).

## • Interworking with Other Services

The DSR-based Voice Portal Service can be combined with the Basic Voice service. This way, all users of the DSR-based Voice Portal Service should be able to use voice portals on any telecommunications network.

## • Roaming Considerations

The subscriber should be able to utilize the DSR-based Voice Portal Service when roaming in any IMS compatible mobile network, where there is an appropriate roaming agreement established. The DSR parameters could be routed back to the home network, if delays are appropriately managed. However, network latencies introduced by traversal over multiple networks might necessitate (seamless) switchover to a closer service provider. For this reason, the capabilities of the DSR-based Voice Portal Service should be available in the roamed-to network in the same manner as in the home network; within the limitation of the capabilities of the serving network.

## • Requirements (for this service)

In addition to the requirements for the Basic Voice service, the following capabilities are required for this service:

- The network should support the IETF packet protocols such as RTP, SDP and SIP.
- The terminal equipment should have the capability to transmit keypad information to the server (e.g., either DTMF or the keypad string)
- The terminal equipment should have at least the default DSR codec (ETSI ES 201 108) specified in the ETSI DSR Standard document “ETSI ES 201 108 v1.1.2 Distributed Speech Recognition: Front-end Feature Extraction Algorithm; Compression Algorithm”, April 2000.
- The network should have uplink streaming capability to enable transmission of DSR front-end parameters to the recognition back-end on the server.
- IMS should support network QoS (Quality of Service) for conversational class services. For example, 150 msec expected and 400 msec maximum for end-to-end one-way delay.

## Quality of Service (QoS) Based Charging

Associated with the introduction of IMS based services is the concept of various levels of Quality of Service (QoS). It is anticipated that each IMS based service offering will have an associated QoS level (e.g., best effort, streaming, conversational, etc.).

Since the QoS used for a service has an impact on the system resources, it should be possible to charge different rates based on the different levels of QoS applied.

Since the QoS requested for a service could be different than the QoS actually allocated for the service, it should be possible to charge either for the QoS requested for a service, or for the QoS allocated. If the network conditions of the serving network only allow the subscriber to be serviced at a lower quality level, the charging should be based upon the actual quality level delivered to the subscriber. For example, a subscriber who requested a service desiring a streaming quality level but able to only received the service with a “best effort” quality level, should be charged based upon the “best effort” quality level and not the streaming quality level. On the other hand, if because of current network conditions, the serving network provides a higher quality than requested, the charge should be based upon the requested quality level and not the delivered quality level.

It could be summarized by saying that the charging should be based on the lesser of the QoS requested and the QoS delivered.

Within each QoS level, there could be several IMS based service offerings which utilize different QoS characteristics. For example, both IMS based basic voice calls and IMS based video calls would utilize the QoS conversational class but these two services have different requirements for delay characters, error protection, bandwidth, etc. It should therefore be possible to charge differently based on the different QoS characteristics that could be used. It is even possible that the same general type of service (e.g., high quality big display video, high quality small display video, low quality video) be delivered with different QoS (e.g. use different CODECS) and so it should be possible to apply different charging rates accordingly.

Due to the nature of the radio environment (e.g., hills, buildings, tunnels, bridges, interference), there will be fluctuations in the radio quality which could cause momentary changes in the delivered service quality. Some of these fluctuations could be perceived by the end user. Changes in delivered service quality should result in the creation of new CDRs so that charging could be adjusted by the network operators, as appropriate. However, a

mechanism should be in place to prevent the home and serving networks from being flooded with CDR type events because the subscriber went through a tunnel, for instance, and caused the QoS to fluctuate frequently. The mechanism used to protect against too many CDRs could be as simple as monitoring the time interval since the last QoS change and only generating a new CDR if the last QoS change was longer than 10 minutes ago. Alternatively, a new CDR could be generated only if the QoS change is outside a certain window size.

---

## Annex C (informative): IP Based Multimedia Services Roadmap

The following text represents the provided output from the Future Evolution Workshop meeting held in Helsinki. It does not necessarily represent the consensus view of 3GPP or 3GPP SA1, and is provided only for consideration by the reader. The content of this section is expected to be subsequently modified such that it does represent the consensus view of 3GPP, pending further input from delegates.

### Basic Assumptions

- Future is evolution not revolution
- Where possible, re-use existing techniques/technologies (potential through co-operation with external fora)
- Stabilise before extending
- Improve requirement setting, e.g., include commercial considerations
- Separate fundamental technology (evolutionary part) from dynamic applications (to ensure rapid development of applications)

### High Level Requirements

- New service/functions shall provide new streams of revenue
- Simplicity for the end user
- Simplicity of network - Optimisation and cost reduction
- Limit the number of options
  - not several services to offer roughly the same service
  - reduce number of competing toolkits
  - not several techniques to provide same service
  - reduce the number of options within protocols
- Define Generic APIs which allow application creation. The APIs should include interface with underlying QoS capabilities
- Create a simple IMS interface towards external networks
  - User access
  - Service interworking
  - Application delivery
- Improve O&M and customer care possibilities
- Improvement for PS domain (e.g., traffic increase)
- Radio Access improvements, e.g., improved spectrum efficiency, quality and coverage
- Utilisation of alternative access technologies, e.g., for hotspot coverage (e.g. WLAN, HIPERLAN, 802.11 a+b, Bluetooth, new technology)
- Seamless service provision across environments

- Exploitation of inherent network functions such as security, authentication billing etc.
- New functions needs to include
  - Charging
  - Security
  - O&M with support for customer care
  - Testing

### **Focus Areas**

- Enhancements of IMS
- Optimisation of dual-mode UTRAN-GERAN
- Wireless LAN Integration/interworking
- Multimedia Broadcast and Multicast
- Infrastructure sharing
- Utilisation of extension bands
- Open & secure terminal Architecture
- Support for Corporate Network
- Support of applications scalable to the terminal capability and environment (e.g. XHTML, J2ME, scalable audio/video)
- Improved QoS handling for realtime

### **Service Examples**

- Financial
  - Micropayment
  - Mobile banking
  - Shopping
  - Stock Trading
  - Recognition techniques
- Location Based
  - Advertising
  - Find a friend, my car, restaurant etc.
- Control and Monitoring
  - Telematics
  - Remote control of appliances
  - Machine to machine communication
- Multi-user applications
  - Video chat
  - Game highlights
  - Shared experience
- Multimedia
  - Voice/multimedia over IP
  - Adult chat line
  - Multimedia Broadcast and Multicast Service\*
- Information
  - Live news

- Transportation
- Preload info prior to travelling
- Distributed Speech Recognition (DSR)\*
- Digital Rights Management (DRM)\*
- Generic user profile\*
- UE functionality split\*

\* Work item exist

### **Summary**

- Be realistic – correct and complete the existing standard before any major new changes are made
- To fully utilise the existing standard, the end-to-end and end-user aspects needs to be in focus
  - Improve the support for 3rd party applications
  - Simplicity for the user
  - Better mechanism for customer care
- Reduce deployment cost and options
- Spectrum efficiency needs to be kept in mind

---

## Annex D: Background Information

### 2 Priority Service

- **Motivation**

There is a need for priority communications among governmental, civil, and other essential users of public telecommunications services in crisis situations, such as earthquakes, severe storms, and floods. Telecommunication services are often restricted during these events due to damage, congestion, and failures. ITU-T Recommendation E.106, International Emergency Preference Scheme (IEPS) and ITU-T Draft Recommendation F.706, International Emergency Multimedia Service (IEMS) describe requirements for emergency telecommunication services that will support recovery activities during crisis situations.

A national security emergency is any occurrence, including natural disaster, military attack, technological emergency, or other emergency, that seriously degrades or seriously threatens the national security. In the United States, national security/emergency preparedness (NS/EP) responsibilities are assigned to Federal departments and agencies by presidential order, but NS/EP responders are found at the Federal, State, and local levels. Other nations may assign responsibilities differently but all nations require the capabilities to marshal their telecommunications resources to react in crisis situations and maintain public safety and national security.

Concurrent with some disasters and emergencies, commercial telecommunications facilities may sustain widespread damage. At a time when the need for real-time electronically processed information is greatest, the capability to acquire these critical resources may be seriously restricted or non-existent. The affected region's ability to communicate with the outside sources may be impaired.

The IEPS/IEMS is intended to enable authorized users to have priority access to telecommunication services and priority processing of communications in support of recovery operations during emergency events. It is essential that appropriate arrangements be established to facilitate these operations among the many telecommunications service providers and nations of the world. While many countries have national preparedness schemes in existing telecommunication systems, the challenge at hand is provisioning appropriate priority indications in the 3G and newly emerging next generation networks. The initial challenge is interfacing the emergency identification established in existing Wireline telephony services with new IP-based services during the transition period when both services must interwork.

Then looking into the future, consideration needs to be given to the new generation of services with their enhanced capabilities that can significantly benefit IEPS/IEMS users and operations. These include email, instant messaging, remote printing, web access, file transfer, wireless access, broadcast/multicast video, interactive video, and domain name server (DNS) lookups. All of these services could be considered for preferential treatment, authorization, and administration for IEPS/IEMS.

- **High Level Service Description**

Subscribers to Priority Services shall be able to subscribe to the IMS Basic Multimedia Service as described in Section 8.1 and the Basic Voice Service as described in Section 8.2. When supporting their NS/EP mission, the Priority Service subscribers shall receive priority over other 3G subscribers in the establishment and completion of a voice call or a data (multimedia) session. Should a service disruption occur, NS/EP voice and data services must be capable of being re-provisioned, repaired, or restored to required service levels on a priority basis.

The system must be able to identify NS/EP Priority Service subscribers and set a priority indicator to identify or mark the priority traffic (voice calls or data/multimedia sessions). There must be procedures and processes to handle priority service traffic that maintains the end QoS to support the communication. The types of processes required for priority service include priority access, priority call set up or session establishment, priority termination, and exemption from restrictive management controls.

- **Relation to IMS**

This service can be offered over the IMS.

- **Potential Revenue Streams (Business Model)**

The network operator may receive revenue from subscribers directly, either on a flat-fee subscription basis, a per-call basis, or some combination of both. Network operators may also receive revenue through third parties (wholesale rates). Network operators may also receive roaming revenue from subscribers roaming from other networks; similarly network operators may pay other network charges when their subscribers roam into different networks. Network operators may receive revenue for ensuring/guaranteeing QoS levels and for personalization of service, i.e., including an icon on call set up, etc.

- **User Perspective (User Interface)**

A user's main interface is a terminal device. While terminal device's interface may be proprietary to the manufacturer, the interaction between the user and the network will need to be uniform.

The user shall be able to either establish and complete a voice call, initiate and complete a data/multimedia session, or a combination of both.

Users can invoke this service either as a permanent subscription or on a per-call/per-session basis. Access can be via the use of a special code/dialing sequence/URL and/or a Personal Identification Number (PIN).

- **Service Specific Considerations**

The assignment and validation of NS/EP priority levels is managed by an organization designated by the appropriate authority.

- **Service Provisioning**

Either a network operator or a third party service provider can provision priority services.

- **Distribution, downloading, terminal capabilities...**

The terminal device requires basic capabilities to provide voice and data services. As a minimum, the terminal device requires a default voice codec, signalling, and a user interface. For multimedia applications, the terminal device requires screen/keyboard-handling capabilities (e.g., a browser) and capabilities for handling desired QoS types (codecs). These capabilities can either be integrated into one unit or supported as peripheral devices via a wired/wireless connection.

- **Charging and Billing**

The user can be charged for sessions in a variety of ways including the following methods:

- g) By the duration of the call or session (including "one-off" charge/flat rate). This includes the possibility to charge only for "session connected" time (as opposed to including the call/session set up time)
- h) By the location of originating party
- i) By the destination of call (including location of called party)
- j) By the amount of services used for the call/session
- k) By the amount of bandwidth used for different media types
- l) By the level of QoS used for each media type

- **Interworking with Other Services**

Interworking is required to other types of networks. When interworking with legacy networks, the capability to transfer and/or translate priority identification is required to the maximum extent possible.

The voice and data services must interconnect and interoperate with other government or private facilities, systems, and networks. Voice and data services must provide access to and egress from international carriers.

To ensure end-to-end compatibility, callers using 3GPP-compatible systems should use the default codec. Calls originating from the IMS to different types of networks (e.g., PSTN, Internet) may need to use gateways.

- **Roaming Considerations**

Priority Services may be available in any compatible mobile network where reciprocal roaming agreements exist.

All session control functions should be available in the roamed-to network in the same way as they are in the home network. They should also be presented to the user in a consistent way (VHE concept).

- **Requirements**



The generic requirements for priority services are identical to the generic requirements for Basic Voice and Multimedia Services.

In addition, priority service must be available network-wide with access to and egress from international service.

Nationwide service may be provided via roaming agreements.

The suite of information security features may be provided by the network and available in the user terminal. Security features include the traditional confidentiality, authentication, integrity, availability, and accountability.

This service may provide broadband service support (e.g., video, imaging, web access, and multimedia).

Priority service users may be allowed to manage the capacity of the communications services to support variable bandwidth requirements.

Priority service users may be given service regardless of user location or deployment status. Means by which this may be accomplished include “follow me”, functional numbering, call forwarding, or functional directories.

Selected users must be able to use priority services without risk of usage being traced (i.e., without risk of user identification or location being compromised). This may be an enhancement to Section 8.8, Identification Restriction.

### **3 Location Services**

#### **Location Services High Level Service Description**

An overview of possible Location Based Services are provided in the following subsections. More detailed descriptions are provided in 3GPP 22.071.

- **Public Safety Services**

Service providers offer these location-based services for the good of the public. They are made available without requiring pre-subscription. They include Emergency Services and Emergency Alert Services.

- **Location Based Charging**

Location Based Charging allows a subscriber to be charged different rates depending on the subscriber's location or geographic zone, or changes in location or zone. The rates charged may be applicable to the entire duration of the call, or to only a part of call's duration. This service may be provided on an individual subscriber basis, or on a group basis. Additionally, different rates may be applied in different zones based on the time of day or week.

In addition to being applicable on an individual basis, this service may be applicable on a group basis, which may be desirable for example, for business groups. Locations may be defined for business groups to include corporate campuses, work zones or business zones with different tiers of charging rates.

Individual and group subscribers should be notified of the zone or billing rate currently applicable, and be notified when the rate changes. Location Based Charging may be invoked upon initial registration. A charging zone would then be associated with the subscriber's location. When the subscriber moves to a different zone, the subscriber would be notified.

This service should be transparently provided to the subscriber (i.e. independent of existing voice calls, data, or other services being provided).

- **Tracking Services**

Tracking services may include Fleet and Asset Management Services allowing the tracking of location and status of specific service group users. Examples may include a supervisor of a delivery service who needs to know the location and status of employees, parents who need to know where their children are, animal tracking, and tracking of assets.

The service may be invoked by the managing entity, or the entity being managed, depending on the service being provided.

Fleet Management may enable an enterprise or a public organization to track the location of vehicles (cars, trucks, etc.) and use location information to optimize services.

Asset management services, for example, may range from asset visualization (general reporting of position) to stolen vehicle location and geofencing (reporting of location when an asset leaves or enters a defined zone). The range of attributes for these services is wide.

- **Traffic Monitoring**

Mobility in automobiles on freeways anonymously sampled to determine average velocity of vehicles. Congestion detected and reported.

Congestion, average flow rates, vehicle occupancy and related traffic information can be gathered from a variety of sources including roadside telematic sensors, roadside assistance organizations and ad-hoc reports from individual drivers. In addition average link speeds can be computed through anonymous random sampling of MS locations.

- **Enhanced Call Routing**

Enhanced Call Routing (ECR) allows subscriber or user calls to be routed to the closest service client based on the location of the originating and terminating calls of the user. The user may optionally dial a feature or service code to invoke the service (\*GAS for closest gas station, etc).

In addition to routing the call based on location, ECR should be capable of delivering the location information to the associated service client. For example, this capability may be needed for services such as Emergency Roadside Service. This could be used for the purpose of dispatching service agents for ECR service clients that can make use of this information.

ECR services may be offered, for example, through menu driven access allowing users to interactively select from a variety of services.

- **Location Based Information Services**

Location-Based Information services allow subscribers to access information for which the information is filtered and tailored based on the location of the requesting user. Service requests may be initiated on demand by subscribers, or automatically when triggering conditions are met, and may be a singular request or result in periodic responses. These may include navigation, city sightseeing, location dependent content broadcast, and mobile yellow pages.

- **Network Enhancing Services**

The Network Enhancing Services are for further study and privacy issues will require further consideration. They may include applications for network planning, network QoS improvements, improved radio resource management.