

TSG-RAN Meeting #11
Palm Springs, CA, U.S.A., 13-16 March 2001

RP-010070

Title: TR 25.854 v1.0.0

Source: TSG-RAN WG1

Agenda item: 6.6.11

Presentation of Specification to TSG RAN

Presentation to: TSG-RAN Meeting #11

Agenda item: 6.6.11 USTS(Uplink Synchronous Transmission Scheme) (WG1)

Document for presentation: TR 25.854 v1.0.0

Presented for: Information

Abstract of document:

This technical report captures the results of the work on the Release 4 study item "Uplink Synchronous Transmission Scheme". It includes status for USTS related work in WG1 and work plan are described.

Changes since last presentation to TSG-RAN Meeting:

We submit the study report which covers all the issues including the overall description, simulation results for USTS performance, complexity, and impacts to other WGs. During WG1 #18 and #19 meetings, timing control update rate has been changed and more descriptive texts have been added regarding soft handover and relevant complexity. The feasibility study has been finished in WG1 which is a leading group of this item. In RAN #11, it is expected for this item to be evolved to Work Item of Release 5 for further detailed discussion.

Outstanding Issues:

Contentious Issues:

3G TR 25.854 V1.0.0 (2001-03)

Study Report

3rd Generation Partnership Project; Technical Specification Group Radio Access Network; Study Report for Uplink Synchronous Transmission Scheme (USTS) (Release 5)



The present document has been developed within the 3rd Generation Partnership Project (3GPP™) and may be further elaborated for the purposes of 3GPP

The present document has not been subject to any approval process by the 3GPP Organisational Partners and shall not be implemented. This Specification is provided for future development work within 3GPP only. The Organisational Partners accept no liability for any use of this Specification. Specifications and reports for implementation of the 3GPP™ system should be obtained via the 3GPP Organisational Partners' Publications Offices.

Uplink Synchronous Transmission Scheme
<keyword[, keyword]>

3GPP

Postal address

3GPP support office address

650 Route des Lucioles - Sophia Antipolis
Valbonne - FRANCE
Tel.: +33 4 92 94 42 00 Fax: +33 4 93 65 47 16

Internet

<http://www.3gpp.org>

Copyright Notification

No part may be reproduced except as authorized by written permission.
The copyright and the foregoing restriction extend to reproduction in all media.

© 2000, 3GPP Organizational Partners (ARIB, CWTS, ETSI, T1, TTA, TTC).
All rights reserved.

Contents

<i>Foreword</i>	5
<i>Introduction</i>	5
1 Scope	5
2 References	5
3. Definitions, symbols and abbreviations	6
3.1 Definitions	6
3.2 Symbols	6
3.3 Abbreviations	6
4. Study Area for USTS	6
4.1. Timing control	7
4.1.1. The reference time	8
4.1.2. Initial synchronization.....	8
4.1.3. Tracking process	9
4.2. Code usage for USTS	10
4.2.1. Scrambling code.....	10
4.2.2. Channelisation code allocation.....	10
4.3. Soft handover in USTS mode	11
5. Performance	16
5.1. Simulation parameters	16
5.2. Simulation results	17
6. Complexity issue	23
6.1. Introduction	23
6.2. Timing control complexity	23
6.3. Different scrambling/channelisation code usage	23
6.4. Soft handover complexity	23
6.5. Impact on closed loop power control	25
7. Impacts to other WGs	26
7.1. WG2	26
7.1.1. RRC layer.....	26
7.1.2. RLC Layer.....	26
7.1.3. MAC Layer	26
7.1.4. Interface between RRC and PHY layer	26
7.2. WG3	26
7.3. WG4	26
8. Backward compatibility	26

Foreword

This Technical Report has been produced by the 3rd Generation Partnership Project (3GPP).

The contents of the present document are subject to continuing work within the TSG and may change following formal TSG approval. Should the TSG modify the contents of the present document, it will be re-released by the TSG with an identifying change of release date and an increase in version number as follows:

Version x.y.z

where:

- x the first digit:
 - 1 presented to TSG for information;
 - 2 presented to TSG for approval;
 - 3 or greater indicates TSG approved document under change control.
- y the second digit is incremented for all changes of substance, i.e. technical enhancements, corrections, updates, etc.
- z the third digit is incremented when editorial only changes have been incorporated in the document.

Introduction

At RAN#9 plenary meeting, a study report for “Uplink synchronous transmission scheme” was decided to be finished by March 2001. Uplink Synchronous Transmission Scheme (USTS) is an alternative technology applicable for low mobility terminals, especially in indoor and dense pedestrian environments. USTS can reduce uplink intra-cell interference by means of making a cell receive orthogonalized signals from UEs. This feature is intended to support uplink synchronous transmission with low overhead, good capacity characteristics, and minimal impact on hardware and software resources at the UE and in the UTRAN.

1 Scope

This study report describes the techniques behind the concept of uplink synchronous transmission scheme and how this concept should be integrated into the overall architecture of UTRA. It also deals with the feasibility of USTS, including performance and expected complexity.

2 References

The following documents contain provisions which, through reference in this text, constitute provisions of the present document.

- ?? References are either specific (identified by date of publication, edition number, version number, etc.) or non-specific.
- ?? For a specific reference, subsequent revisions do not apply.
- ?? For a non-specific reference, the latest version applies.

[1] TS25.133 : Requirements for support of radio resource management (FDD)

- [2] TS 25.211 : Physical channels and mapping of transport channels onto physical channels (FDD)
- [3] TS 25.213 : Spreading and modulation (FDD)
- [4] TS 25.214 : FDD : Physical layer procedures
- [5] TS 25.302 : Services provided by the Physical Layer
- [6] TS 25.331 : Radio Resource Control (RRC) Protocol Specification
- [7] TS 25.423 : UTRAN Iur Interface RNSAP Signalling
- [8] TS 25.433 : UTRAN Iub Interface NBAP Signalling
- [9] TS 25.435 : UTRAN interface User Plane Protocol for Common Transport channel Data Streams
- [10] TR 25.926 : UE Radio access capabilities definition
- [11] TR 25.839 : Uplink Synchronous Transmission Scheme (USTS) (Iur/Iub aspects)

3. Definitions, symbols and abbreviations

3.1 Definitions

No specific definition is made in this document.

3.2 Symbols

T_{ref}	Reference time
T_{INIT_SYNC}	Amount of adjustment for initial synchronisation

3.3 Abbreviations

For the purposes of the present document, the following abbreviations apply:

CFN	Connection frame number
DPCCH	Dedicated physical control channel
DPDCH	Dedicated physical data channel
RTD	Round trip delay
RTPD	Round trip propagation delay
TAB	Time alignment bit
UE	User equipment
USTS	Uplink synchronous transmission scheme
UTRAN	Universal terrestrial radio access network

4. Study Area for USTS

<Note> USTS is optional for both UE and UTRAN.

Figure 4.1 describes DPCH arrival times from UEs in the Node B with and without USTS. Without USTS, the uplink signals from different UEs arrive at different time instants. The beginning point of radio frame in the Node B differs for different UE due to different value of T_{DPCH} and different propagation delay (RTPD: Round Trip Propagation Delay). And accordingly, different scrambling codes are used for different UEs to discriminate them and the interference from other users is determined by the cross-correlation among scrambling codes.

USTS makes the signals orthogonal by sharing a common scrambling code and assigning different channelisation codes to the UEs similarly to the downlink. In order to preserve orthogonality at the receiving side (Node B), the transmission time at the UE side needs to be adjusted so that the arrival times in the Node B becomes $?_{DPCH} ? T_0 ? T_{ref}$, where T_{ref} is the reference time. In the figure, T_{ref} corresponds to the distance in chips between P-CCPCH frame timing at Node B and the nearest red dotted vertical line to the right. The transmission timing control needs to be done at call setup phase and during call as well to compensate both the initial propagation difference and the variation due to UE movement. Since the channelisation codes repeat every 256 chips at least and $?_{DPCH}$ is a multiple of 256 chips, the orthogonality among channelisation codes can be maintained when different $?_{DPCH}$ is assigned to different DPCH. After descrambling, only channelisation codes need to remain as in the downlink to get orthogonality. To do so, the generation of the common scrambling code is controlled to start at a same reference time for all users. By eliminating the interference from the first detected paths of other UEs, USTS can improve the uplink performance. Currently, UE has only one transmitter and hence, the transmission timing can be adjusted with respect to only one of the cells in Active set. This means USTS can get a performance gain through suppressing intra-cell interference not inter-cell interference. In indoor and dense pedestrian environments, since most of the signal power is carried along the first resolvable path with a chip rate of 3.84 Mcps, high performance gain can be expected by adopting USTS in these environments. USTS is targeting these environments not only because of its good performance but also because of possible need of high uplink capacity in these environments with imposing small modification onto current specifications.

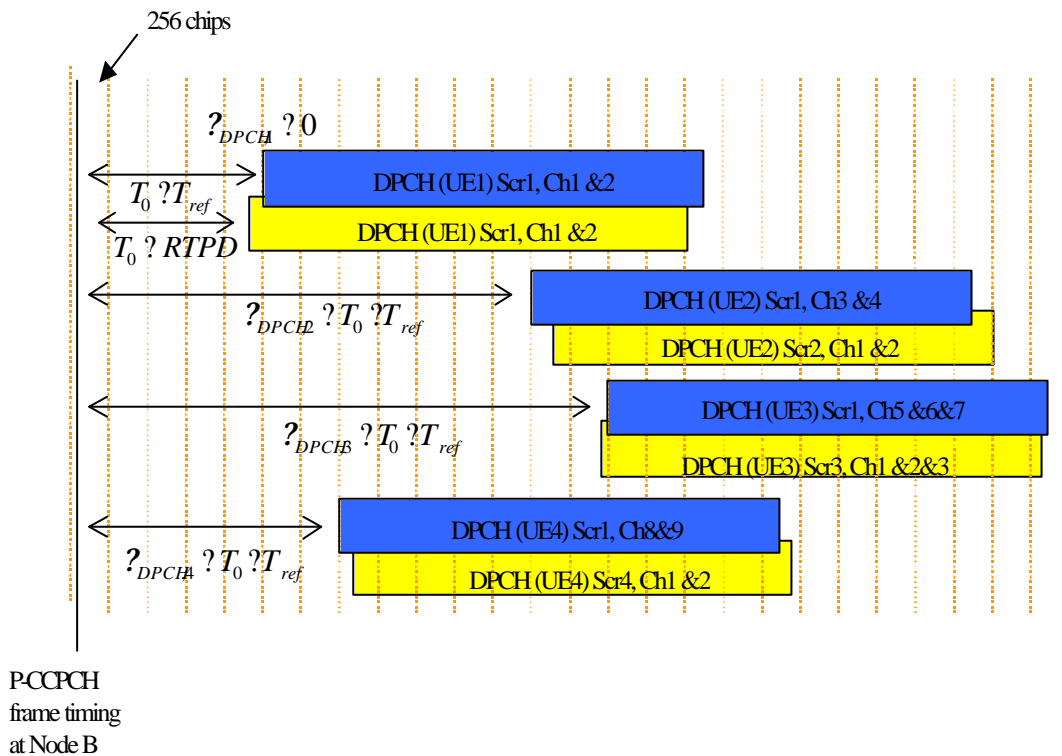

Figure 4.1 DPCH arrival times from UEs in the Node B with/without USTS (4 UEs, Yellow: without USTS, Blue: with USTS)

4.1. Timing control

In USTS mode, time alignment is required to preserve orthogonality between channelisation codes from different UEs and also to properly despread the cell-specific long scrambling code. The transmission time at UE is adjusted in two steps. The first step is Initial synchronization and the second is tracking process.

- 1) Initial synchronisation: Adjust transmission time according to the initial timing control information given by higher layer through FACH.

- 2) Tracking process (Closed Loop Timing control): Adjust the transmission time according to the Time Alignment Bit (TAB) over DPCCH.

In Figure 4.2, before adjustment, DPCH message is expected to arrive at point A, where $\tau_{DPCH,n}$ is a multiple of 256 chips offset and T_0 is constant. After adjustment according to T_{INIT_SYNC} , the arrival at Node B is scheduled to occur at point B, $\tau_{DPCH,n} + T_0 + T_{ref}$ later from the beginning of each P-CCPCH frame in the Node B. There may be variation around point B due to movement of UE and this can be overcome by Tracking process using TAB commands. And accordingly, it keeps the uplink DPCCH/DPDCH frame of a UE arriving at Node B at the same point. In return, the UL/DL relative timing is not fixed but is to vary in the range with a width of 2τ . The width and the range are closely related to the reference time T_{ref} .

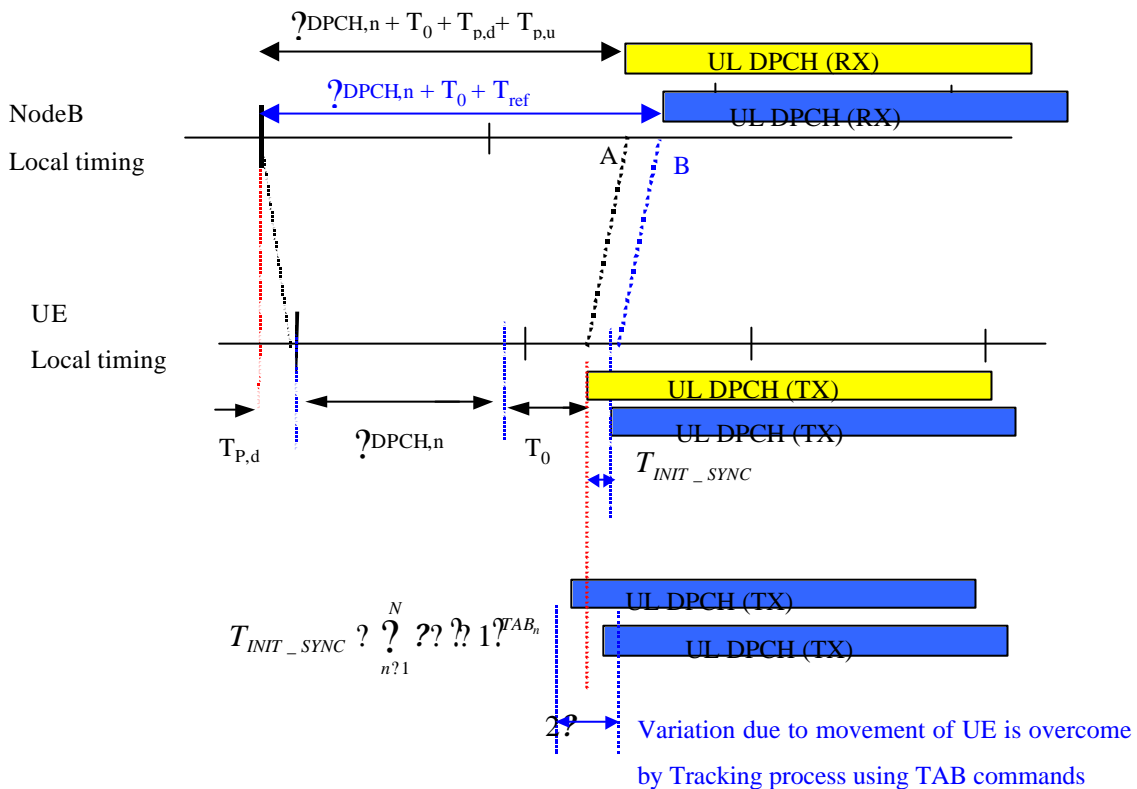

Figure 4.2 Initial synchronisation and Tracking process for DPDCH/DPCCH (Yellow: before adjustment, Blue: After adjustment).

4.1.1. The reference time

T_{ref} is given to RNC as initial loading data and the desired arrival time becomes $\tau_{DPCH,n} + T_0 + T_{ref}$ in the Node B. Since $\tau_{DPCH,n} = T_n \cdot 256$ chip, $T_n \in \{0, 1, \dots, 149\}$, the desired arrival time may exist every 256 chips according to $\tau_{DPCH,n}$. Different UE arrives at the cell at one of the desired arrival times according to $\tau_{DPCH,n}$ and the orthogonality among channelisation codes can be preserved. The proposed value for T_{ref} is the maximum one-way propagation delay and for example, it comes to 128 chips for a cell radius of 10 km and a chip rate of 3.84 Mcps.

4.1.2. Initial synchronization

First, UTRAN obtains the round trip propagation delay (RTPD) by doubling the value of PRACH Propagation Delay measured in TS 25.215 and sets the amount of adjustment for initial synchronisation T_{INIT_SYNC} to compensate the

difference between the RTPD and T_{ref} . UE adjusts its transmission time according to T_{INIT_SYNC} delivered from UTRAN through FACH. Since T_0 is a constant (1024 chips) and T_{ref} is a given value and same for all UEs in a cell, after initial synchronisation, the arrival in the Node B can be controlled to occur within $[T_{DPCH,n} - T_0 - T_{ref} - 1.5chips, T_{DPCH,n} - T_0 - T_{ref} + 1.5chips]$ due to 3 chip resolution for reporting PRACH Propagation delay.

4.1.3. Tracking process

4.1.3.1. Time Alignment Bit (TAB)

In case of USTS, a proper timing control rate needs to be determined by considering the synchronisation performance of timing control and the impact on closed loop power control performance. One proposal is that the TPC bits are replaced by Time Alignment Bits (TABs) every two frames (20 msec timing control interval).

4.1.3.2. Closed loop timing control

The proposed procedure is as follows;

- Node B compares the received arrival time with the desired arrival time from UE every 200 msec (according to WG4 UE transmit timing assumptions [1]).
- When the received arrival time is earlier than the desired arrival time at a Node B, Time Alignment Bit (TAB) is set to "0". When this is later than the desired arrival time, TAB = "1".
- TAB replaces the TPC bit in slot #14 in frames with $CFN \bmod 2 = 0$.
- At the UE, a number of Time Alignment Bits are combined over a 200 ms interval, which increases the reliability of the time alignment process.. When the combined time alignment command is judged as "0", the transmission time shall be delayed by ΔT , whereas if it is judged as "1", the transmission time shall be advanced by ΔT . ΔT is the timing control step size, whose minimum value depends on the oversampling rate.

4.1.3.3. Proposed adaptive tracking scheme after Initial synchronization

< The step size in this section is just a proposal. The step size in normal tracking process is denoted as ΔT in subsection 4.1.3.2 and this value can be constant in the range between maximum and minimum values or it can be adaptively changed in that range. What value is optimal in view of synchronisation performance and how to adaptively change the step size if needed is FFS >

The adaptive tracking scheme after initial synchronisation changes the TAB command period and timing control step size to reduce the impact of coarse initial synchronisation due to 3 chip resolution at initial synchronisation phase. In other words, when a UE enters USTS mode it can adjust its uplink transmission time with the timing control step bigger in size than that of the normal tracking process and the TAB command period shorter than that of the normal tracking process during initial several frames.

- The timing control step size is $3 \cdot \Delta T$ for the first TAB period and the timing control step size is $1/4$ for the other TAB periods
- A TAB command is transmitted to UE once every frame during the first three frames and is transmitted once every 2 frames (20ms) after three frames are transmitted.

4.2. Code usage for USTS

4.2.1. Scrambling code

The long scrambling code described in Section 4.3.2.2. of TS 25.213 is used. However, this long scrambling code is not UE specific but is common to a number of UEs, and the initial loading value of PN generator is determined by the network. The spreading and modulation scheme for USTS is same as in Section 4 of TS 25.213.

In USTS mode, a number of UEs share a common scrambling code and the different and orthogonal channelisation codes needs to be allocated to each UE. To preserve orthogonality among channelisation codes, the UEs need to start to generate the common scrambling code at the same reference time (e.g., P-CCPCH frame time). Figure 4.3 shows a simple example with two UEs. Different UE uses different orthogonal codes to discriminate UE (exactly speaking, discriminate channel) and the UEs use a same scrambling code. Channelisation codes repeat at least every 256 chips but a scrambling code repeats every 10 msec (38400 chips). To obtain the orthogonal property in USTS mode, the scrambling code has to be aligned at chip level as described in the Figure 4.3. Accordingly, two UEs are modulated with a same scrambling chip value if they are at the same time point.

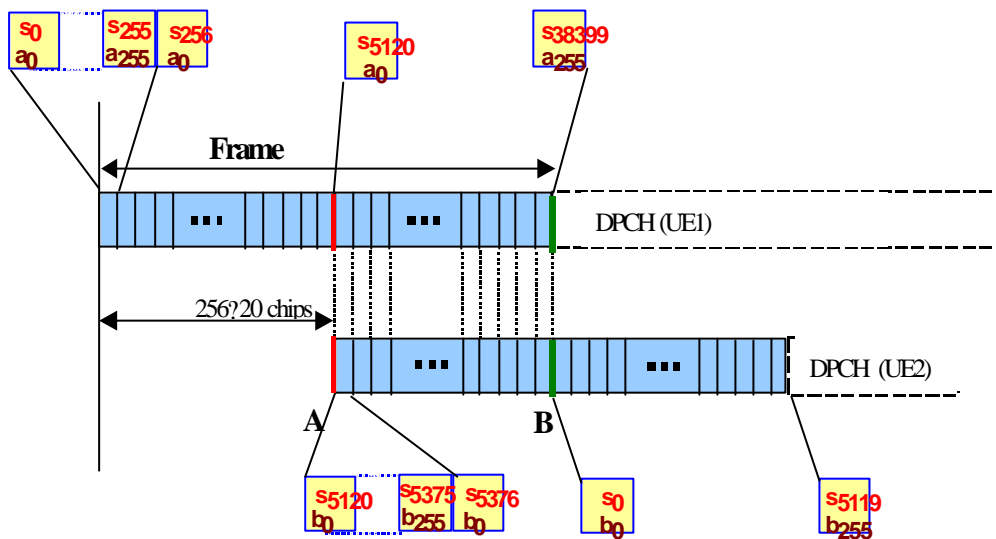

Figure 4.3 Timing at Node B and usage of scrambling and orthogonal codes in case of two UEs (a,b : channelisation codes, s : scrambling code, SF = 256)

In order to prevent channelisation code shortage problem, more than one scrambling codes can be used. In this case, since the USTS gain can be obtained among the UEs sharing a same scrambling code, a careful scrambling code assignment is needed to maximise the USTS gain. For example, in case of two scrambling codes for USTS, if the channelisation codes of a scrambling code are used up, channelisation codes of an additional scrambling code can be used.

4.2.2. Channelisation code allocation

Since UEs in USTS mode may share a common scrambling code, the UE discrimination is done by channelisation codes. At least two codes are needed to each UE: one for DPCCH and the other for DPDCH. In case of USTS, the channelisation codes for DPDCH(s) and DPCCH in a UE are chosen among unoccupied OVFSF codes by other UEs from either upper half part or lower half part of OVFSF code tree of a common scrambling code. The spreading factor and node number of channelisation code are delivered from network to each UE.

Reference: 3GPP TSG R1-99-581, “Channelisation code assignment for RSTS”, ETRI.

4.2.2.1 Proposed OVFSF code allocation rule for USTS

<This is one proposed way of doing code allocation>

The performance gain of USTS improves as more UEs share the same scrambling code. If OVFSF codes are allocated inefficiently, fewer UEs can share the scrambling code. Since the SF of OVFSF code for DPCCH is always 256 while the SF of OVFSF code for DPDCH can be between 4 and 256, a special OVFSF code allocation rule can be introduced to allocate OVFSF codes to more UEs.

Mapping Rule of Channelisation Code between DPDCH and DPCCH is as follows:

- The sub-trees below the nodes $C_{ch,8,3}$ and $C_{ch,8,7}$ are reserved for DPCCH.
- **In the upper half code tree**, for the channelisation code for the DPDCH, the index k of $C_{ch,SF,k}$ shall be chosen from the following range.

$$k = \begin{cases} 0, 1, \dots, (SF/8 - 1) & \text{if SF} \leq 64 \\ 0, 2, \dots, 46 & \text{if SF} \leq 128 \\ 0, 4, \dots, 92 & \text{if SF} \leq 256 \end{cases}$$

And, the channelisation code for the associated DPCCH shall be $C_{ch,256,127-n}$, where

$$n = 64 \cdot k / SF$$

- **In the lower half code tree**, for the channelisation code for the DPDCH, the index k of $C_{ch,SF,k}$ shall be chosen from the following range.

$$k = \begin{cases} SF/8, (SF/8 + 1), \dots, (SF/8 - 1) & \text{if SF} \leq 64 \\ 64, 66, \dots, 110 & \text{if SF} \leq 128 \\ 128, 132, \dots, 220 & \text{if SF} \leq 256 \end{cases}$$

- And, the channelisation code for the associated DPCCH shall be $C_{ch,256,255-n}$, where

$$n = 64 \cdot k / SF$$

If more than one channelisation codes for DPDCHs are allocated to a UE, then the channelisation code for DPCCH corresponding to the first allocated channelisation code for DPDCH will be used as the channelisation code for the DPCCH.

4.3. Soft handover in USTS mode

<This section is describing only sample candidates which is restricted to USTS Study report and not universal description of soft handover procedure>

For seamless communication, soft handover needs to be considered for USTS, where the different code usage of scrambling and channelisation codes, and the transmission timing control should be taken into account.

The radio link can be in one of the following three modes:

- Normal mode : No timing control, UE discrimination by Scr code
- USTS mode : Timing control, UE discrimination by both Scr and Ch codes
- Non-USTS mode : No timing control, UE discrimination by both Scr and Ch codes

The difference between Normal mode and Non-USTS mode is as follows. If one of the radio links to the cell sites in Active set is in USTS mode, it is discriminated by both scrambling code and channelisation codes assigned for USTS mode in all cells in Active set. Therefore, the other links should be in non-USTS mode. This is because the UE has only a single transmitter and there can be more than one UEs who enter the SHO region from the same original cell and accordingly, they use the common scrambling code and the discrimination can be done only by channelisation codes. In normal mode, the UEs in SHO region use their own unique scrambling codes.

Four candidates for supporting soft handover have been proposed in USTS mode. Table 4.1 summarises these candidates. In this section, only two-way soft handover is considered for easy understanding. In Candidate 1, when the UE enters SHO region, it abandons the USTS mode and operates in normal mode with both cell sites. For this, a reconfiguration process is first required to assign new scrambling codes and channelisation codes for the radio link with

the original cell and then, the normal soft handover procedure is followed. When the UE moves further into the target cell and leaves out of SHO region, it continues to be in normal mode with stronger radio link. If it leaves out of SHO region back into the original cell, it resumes the USTS mode and accordingly, for normal to USTS mode transition, reconfiguration process is required to assign new scrambling code and channelisation codes, and timing adjustment is necessary. Candidate 2 is different from Candidate 1 only in that the soft handover happens in the reverse direction.

In Candidates 3 and 4, the UE continues to be in USTS mode with either of two cell sites in SHO region, which may provide better performance. In Candidate 3, the UE keeps the radio link with the original cell site being in USTS mode until it moves out of the coverage of the original cell. When the UE drops the radio link with the original cell, it changes the mode of the radio link with the target cell to USTS mode. At this point, reconfiguration of scrambling and channelisation codes and also the timing control are required for non-USTS to USTS mode transition. If the UE returns to the original cell, just dropping the weaker radio link is the only thing the UE has to do.

In Candidate 4, the radio link modes of both links are changed in the middle of soft handover, which may improve the performance by providing USTS mode to a better radio link compared to Candidate 3. When the change point is at the cell boundary, Candidate 4 is the same as Candidate 3. And therefore, Candidate 3 can be seen as a special case of Candidate 4. If the change point is anywhere inside the SHO region, the optimum point and how to detect it need to be elaborated further.

Table 4.1 Four soft handover candidates for USTS (A simple example in case of two-way soft handover).

Movement of UE	The mode of UE		
	In original cell	In SHO region	In target cell
Candidate 1	USTS	Normal(O)+Normal(T)	Normal
Candidate 2	Normal	Normal(O)+Normal(T)	USTS
Candidate 3	USTS	USTS(O)+Non-USTS(T)	USTS
Candidate 4	USTS	USTS(O)+Non-USTS(T) \neq Non-USTS(O)+USTS(T)	USTS

<Note> (O) : the mode with the **original** cell (T) : the mode with the **target** cell

If the new cell does not support USTS, only candidate 1 is applicable. And Candidate 2 is applicable when the original cell does not support USTS. R5 Node B means that it has the following two capabilities:

- (1) timing control.
- (2) discrimination of different UEs with both scrambling code and channelisation code(s).

R99/R4 Node B does not have either of two capabilities.

Figure 4.4 shows handover procedure for candidate 3 in more details. Both cells are in USTS mode, and UE2 and UE3 are in USTS mode with Node B1 and Node B2, respectively. When UE1 is in USTS mode, Node B1 assigns Scr1 and Ch3 to UE1. During soft handover, UE1 continues to use these codes and continues to be in USTS mode with Node B1. However, while UE1 is in SHO but it is in non-USTS mode with Node B2 because Tx timing of UE is controlled only to Node B1. When the UE1 moves out of SHO region, reconfiguration is required to assign new Scr and Ch codes and to inform the amount of timing adjustment for non-USTS to USTS transition. The amount of timing adjustment can be calculated with Round trip time measured in TS 25.215 (accordingly, RTPD) and T_{ref} . At this point, abrupt timing control may be required, which results in transmission gap at UE1. The same procedure is also required for normal to USTS mode transition.

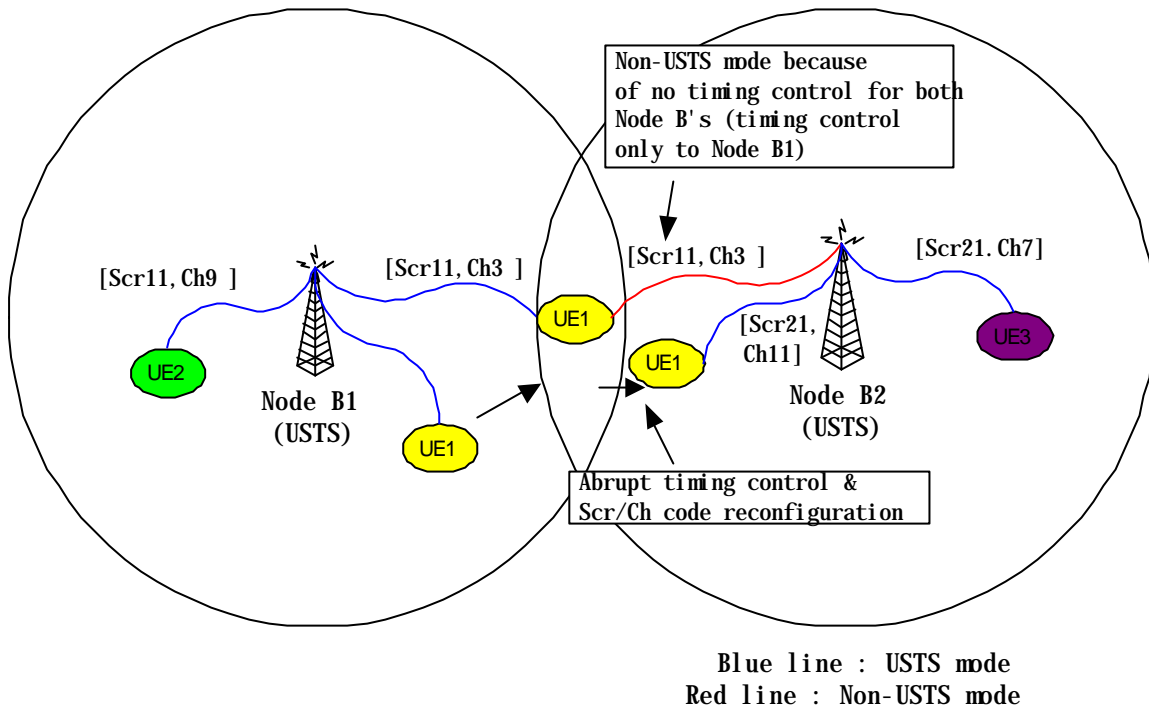

Figure 4.4 Two-way soft handover procedure for Candidate 3.

Figure 4.5 shows the handover candidate 4 in two-cell layout. Both Node Bs are operated in USTS. UE1 and UE2 are operated in USTS with Node B #1 and Node B #2, respectively. Let us focus on UE0 with interest. When UE0 is operated in USTS with Node B #1, UE0 gets scrambling code (Scr11) and channelisation code (Ch3) from Node B #1. When UE0 enters into the handover process, the radio link in non-USTS mode with Node B #2 is set up. Note that only Node B #1 controls the transmit timing of UE0, which uses the same codes and is operated in USTS with Node B #1. While UE0 exists in the soft handover region, the reconfiguration process is required to assign new scrambling code (Scr21), channelisation code (Ch11) and timing adjustment for non-USTS to USTS transition in Node B #2. Also USTS to non-USTS transition in Node B #1 is required to preserve the reliability from soft handover. The required timing adjustment for new USTS link can be obtained by RTPD and Tref in the same manner with candidate 3. Timing of non-USTS link in Node B #1 is acquired by the new USTS time adjustment and the time difference between Node B #1 and Node B #2. Finally, UE0 releases the radio link with Node B #1 when the UE0 does not need soft handover and soft handover process is completed.

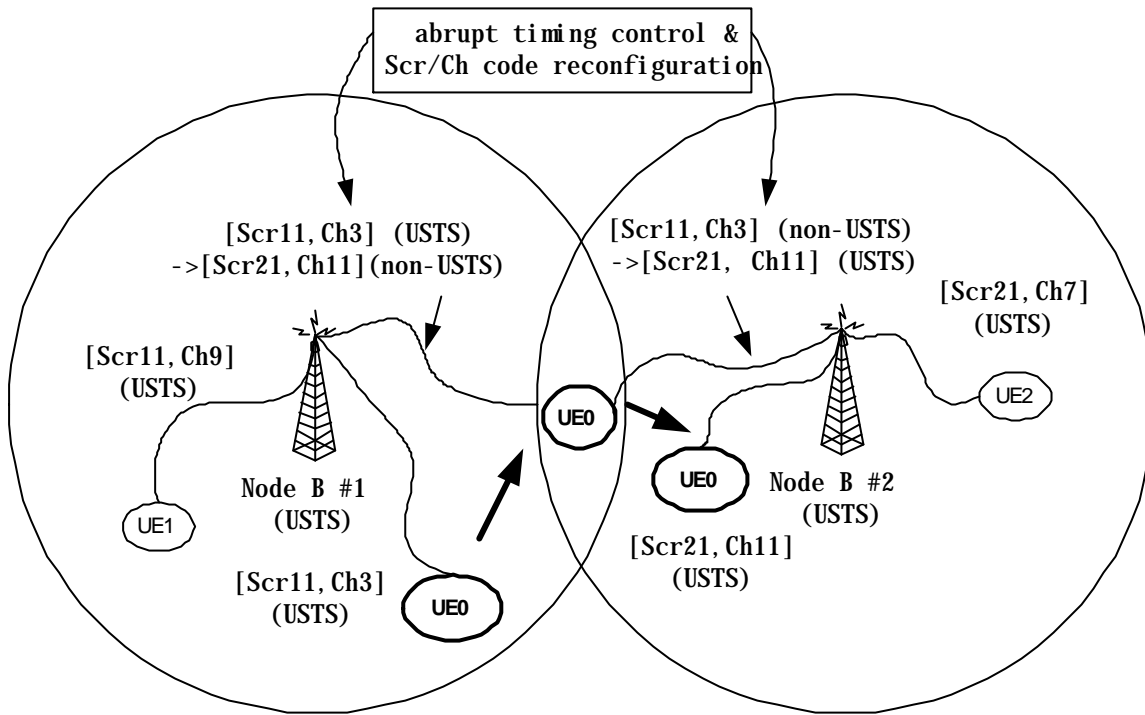

Figure 4.5. Two-way soft handover procedure for candidate 4.

Figure 4.6 describes the arrival timing at Node B1 and Node B2. The arrival times from UEs in the Node B1 are controlled to be $?_{DPCH,1i} ? T_0 ? T_{ref}$ from the beginning of P-CCPCH1. Since $?_{DPCH,1i}$ is a multiple of 256 chips, the possible arrival point at Node B1 repeats every 256 chips. During soft handover, UE3 is in USTS mode with Node B1 and therefore, its arrival time at Node B1 is kept at $?_{DPCH,13} ? T_0 ? T_{ref}$. However, even though the UE3 is in SHO with Node B2, it is in non-USTS mode because the arrival time at Node B2 is not controlled to guarantee synchronized reception with UE4 & UE5. When UE3 moves further into Node B2 area and drops the old link, then in order to be in USTS mode with Node B2, the arrival time at Node B2 needs to be controlled. Point a or point b can be chosen for USTS and their difference is 256 chips. To prevent abrupt timing advance at UE side, point b is always selected and therefore, transmission gap may result, which is less than 256 chips, i.e., the transmission at UE needs to be stopped for less than 256 chips and resumes after the gap. For this, $?_{DPCH,23}$ needs to be reassigned when selecting point b.

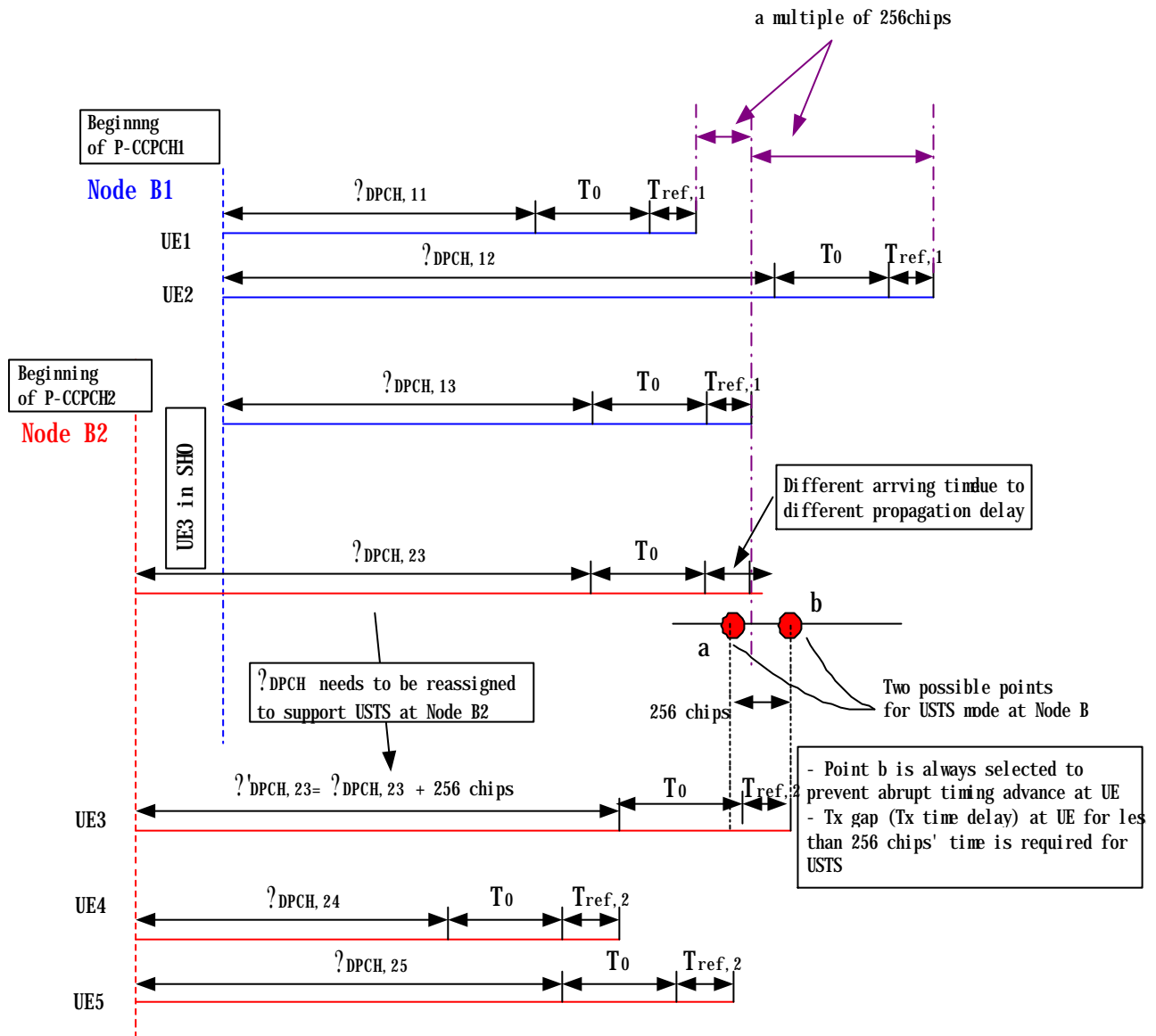

Figure 4.5 Arrival timing at Node B1 and Node B2

Reference

[1] R1-01-0061, "Comparison of soft handover for USTS", LGE

5. Performance

5.1. Simulation parameters

- The first detected paths (in time) of UEs are aligned
- Channel model : outdoor urban high-rise channel model (JTC)
 - : ITU indoor and pedestrian models
- Number of Rake fingers = 1, 3
- Mobile speed : 3 km/h, 5.6 km/h, 20 km/h, 60 km/h
- SF : 128
- Single cell
- Closed power control : OFF
- Channel estimation : Ideal
- No channel coding
- Number of oversamples per chip : 4, 8
- Modulation/Spreading : QPSK/complex, BPSK
- Carrier frequency : 1.9 GHz, 2 GHz

5.2. Simulation results

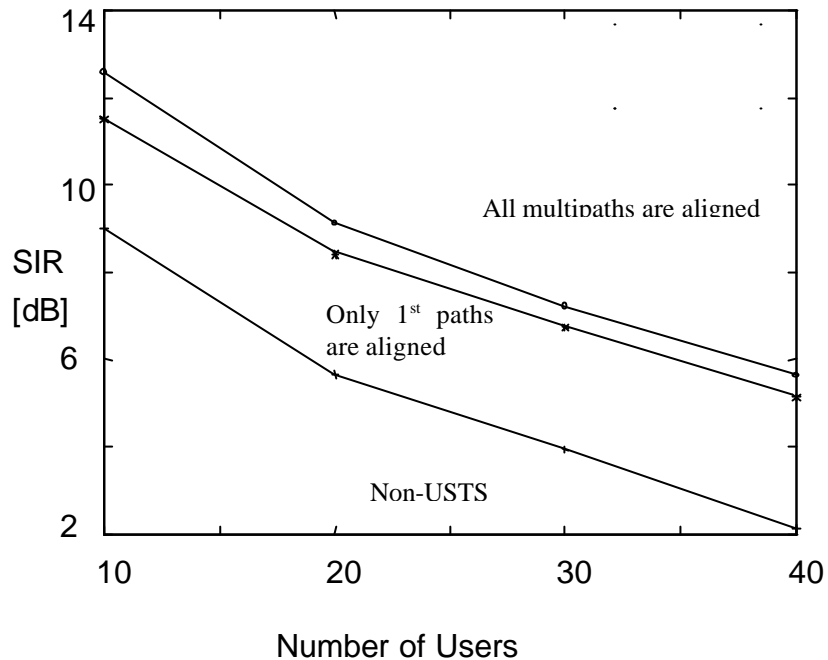

Figure 5.1 SIR comparison for varying the number of users under JTC channel model

- Channel model : outdoor urban high-rise channel model (JTC)
- Number of Rake fingers = 3
- Mobile speed : 5.6 km/h
- All UEs are either in USTS mode or in non-USTS mode
- Timing alignment precision : [-1/8 chip, +1/8 chip]
- Modulation/Spreading : BPSK
- Carrier frequency : 1.9 GHz

✍ About 3 dB gain in SIR can be achieved compared to non-USTS

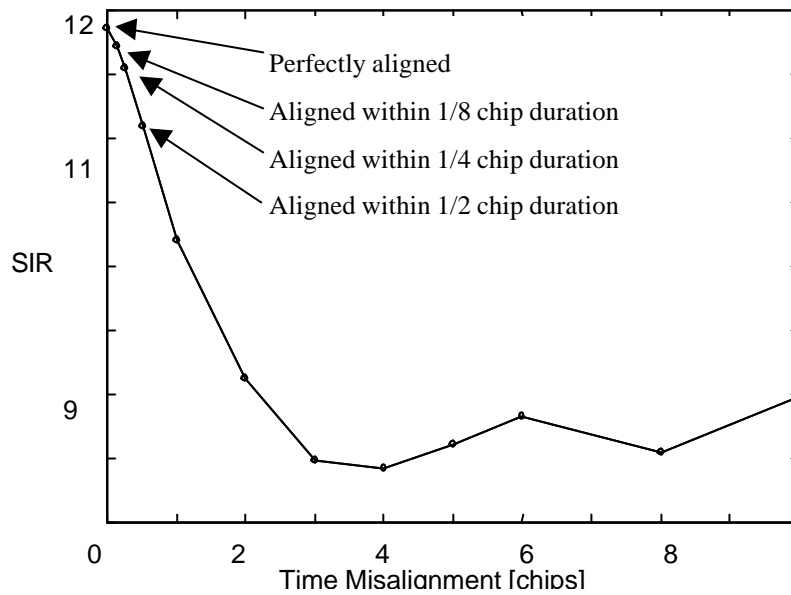

Figure 5.2 Impact of timing control resolution.

- Number of users = 10
- All UEs are in USTS mode
- Channel model : outdoor urban high-rise channel model (JTC)
- Number of Rake fingers = 3
- Mobile speed : 5.6 km/h
- Modulation/Spreading : BPSK
- Carrier frequency : 1.9 GHz

<Note> The amount of misalignment is randomly chosen in the range of $[-x, +x]$ chips and therefore, the arrival times of UEs are randomly distributed around the desired arrival time.

<Note> If the amount of misalignment is larger than 3 chips, the obtainable SIR in USTS mode is the same as in non-USTS mode (refer to Fig. 5.1)

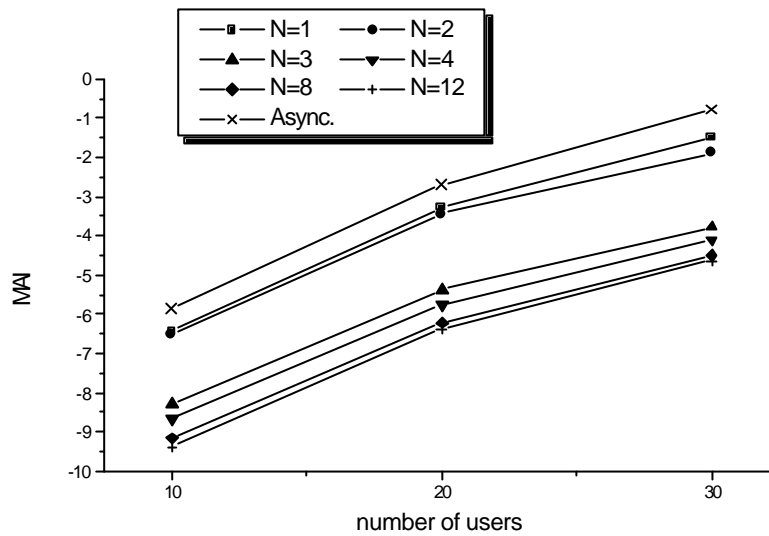

Figure 5.3 Timing control rate versus channel variation rate

- All UEs are in USTS mode
- Channel model : ITU-R Vehicular B model
- Number of Rake fingers = 3
- Mobile speed : 20 km/h
- Modulation/Spreading : BPSK
- Carrier frequency : 1.9 GHz
- Timing control step size = 1/4 chip
- N = the ratio of timing control rate to average channel variation rate
- The average channel variation interval = 100 msec
- Delay variation is randomly selected from [0,1] chip range

⚠ For $N > 3$, the additional performance improvement is less than 1 dB.

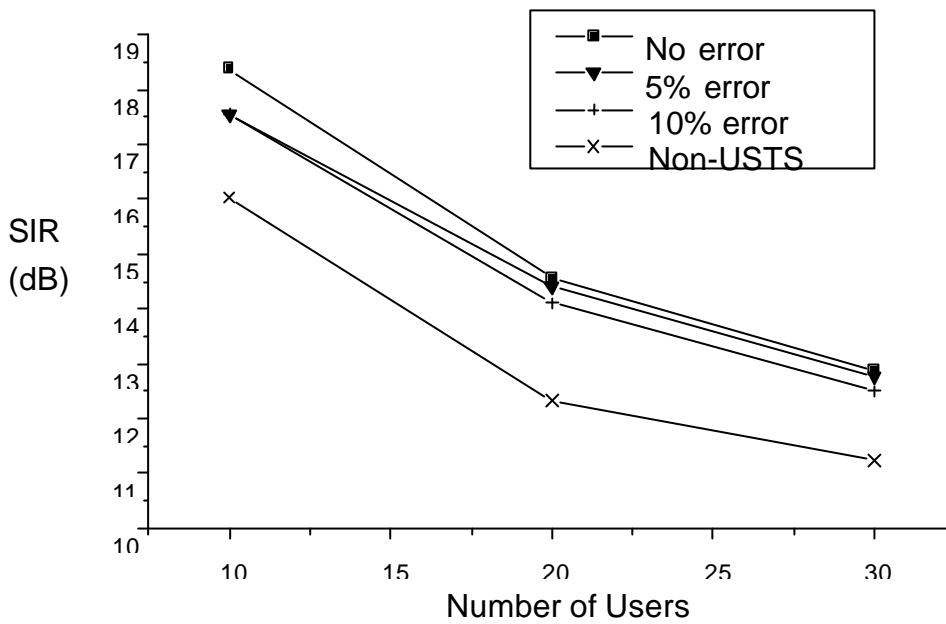

Figure 5.4 Impact of TAB error

- All UEs are in USTS mode
- Channel model : ITU-R Vehicular B model
- Number of Rake fingers = 3
- Mobile speed : 60 km/h
- Modulation/Spreading : BPSK
- Carrier frequency : 1.9 GHz
- Timing control step size = 1/4 chip
- Timing control interval = 25 msec
- The average channel variation interval = 100 msec
- Delay variation is randomly selected from [0,1] chip range

~~For~~ For less than 10 % error in TAB, the performance degradation is less than 1 dB in SIR.

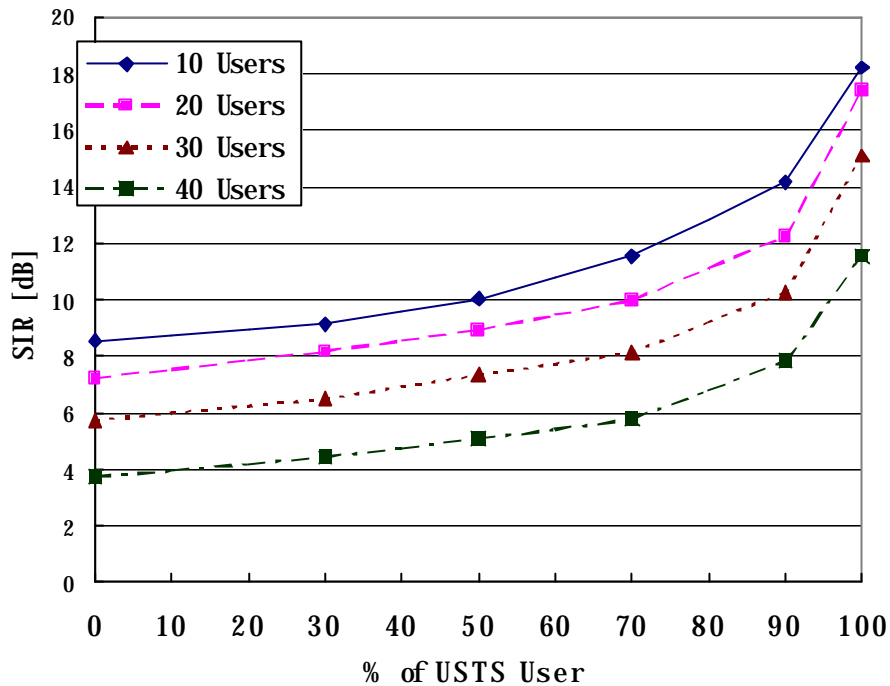

Figure 5.5 Performance in a USTS/non-USTS mixed situation

- Channel model : Pedestrian A (Speed : 3 km/h)
- Number of oversamples per chip : 4
- Carrier frequency : 2 GHz
- Number of fingers = 1
- Modulation/Spreading : QPSK/complex
- Chip rate : 3.84 Mcps

<Note 1> Under the above channel model, the first three paths are very close to each other so that they are within one chip duration and therefore, they are not discriminated. And the signal powers of the other paths are very small. Accordingly, choosing one Rake finger in the simulation is reasonable under this channel model.

<Note 2> The percentage of USTS users largely affects the performance gain. In case of Candidates 2 and 3, if all UEs support USTS, then 30 % of them are usually in SHO. If the multiple cell system is taken into account, no more than 85 % of UEs can be in USTS mode from the view point of the cell under consideration.

<Note 3> Compared to the single cell system, if multiple cell (other cell) and soft handover are taken into account, the performance gain of USTS is reduced. For example, if the other cell interference factor f is 0.77 and half of the UEs in SHO are assumed to be in non-USTS mode, the gain is reduced by half approximately. However, the performance gain of USTS is still high, especially in indoor and dense pedestrian environments.

Table 5.1 Average SIR comparison under various channel models (10 UEs).

Channel model	USTS (100 %)	Non-USTS (100 %)
Indoor A	14.57 dB	9.02 dB
Indoor B	12.78 dB	7.49 dB
Pedestrian A	18.22 dB	8.54 dB
Pedestrian B	11.42 dB	8.73 dB

<Note> We also have simulation results in Indoor A and Pedestrian B channel models. As more strong multipaths exist, the performance gain of USTS decreases. However, since in most cases of indoor or pedestrian environment, the first detected path is relatively stronger than any other paths, good performance gain can be expected by using USTS.

6. Complexity issue

6.1. Introduction

This section discusses the complexity of USTS in terms of timing control, different scrambling and channelisation code usage, soft handover processing, and the impact on closed loop power control. Both hardware and computational complexities are presented in this section.

6.2. Timing control complexity

Timing control is required for synchronised reception in the Node B at initial synchronisation phase, tracking process during call, and at normal/non-USTS to USTS mode transition for soft handover. UE advances or delays its transmission time by a given amount of time delivered from Node B for initial synchronisation and tracking process. However, UE only performs transmission time delay at mode transition to USTS for soft handover to prevent possible data loss due to abrupt time advance, which may require DL timing adjustment. Node B needs to measure PRACH Propagation delay at call setup phase and report it to RNC. Then, RNC calculates T_{INIT_SYNC} using the reported value and T_{ref} and then, inform the corresponding UE of this value through FACH. During tracking process, Node B continuously measures the DPCH frame arrival time and compares it with the desired arrival time. Then, it punctures the TPC bits with the TAB commands. For this timing control, some computational complexity is expected in RNC, Node B, and UE, which may need additional processing power or hardware but is expected to be quite small due to its simple arithmetic operation. Additional signalling is needed to carry the amount of timing adjustment. However, for tracking process there is no signalling load increase because tracking process carries the information by puncturing TPC bits. Since USTS is targeting indoor and dense pedestrian environments, handover does not occur so frequently. Moreover, the additional signalling load per call is expected to be quite small, compared to the total signalling load. Only a small amount of signalling load increase is expected at call setup phase and for handover.

6.3. Different scrambling/channelisation code usage

USTS assigns scrambling/channelisation codes differently from current specifications to get orthogonal property in the uplink. Since it uses the same scrambling/channelisation code generators, USTS requires a small additional hardware. However, differently from the current specifications, the same initial loading value for scrambling code and different channelisation code(s) are assigned to the UEs in USTS mode (there may be an exceptional case when more than one scrambling codes are used for USTS). RNC may need additional computation not to violate this rule. Regarding channelisation code assignment, if properly designed, only the information about the DPDCH channelisation code(s) needs to be delivered to UE. This is applied for call setup and mode transition in handover.

6.4. Soft handover complexity

Timing control complexity and different assignment of scrambling/channelisation codes are discussed in the previous two subsections. Most of the complexity for soft handover is related to higher layers and will be dealt with in WG2 and WG3. UL/DL timing related issues in soft handover will be discussed in the following subsection because it is closely related to the CLPC.

Table 6.1 Complexity comparison of four soft handover candidates (two-way case, O: Original cell, T: Target cell)

Case	Candidate 1	Candidate 2	Candidate 3	Candidate 4 *
Adding a new link	Scr/Ch code reconf. (O,T,UE)	Radio link setup (T)	Radio link setup (T)	Radio link setup (T)
Dropping the link with original cell	Nothing	Scr/Ch code reconf. (T,UE) & Timing adjust. (T,UE)	Scr/Ch code reconf. (T,UE) & Timing adjust. (T,UE)	Nothing
Dropping the link with target cell	Scr/Ch code reconf. (O,UE) & Timing adjust. (O,UE)	Nothing	Nothing	Scr/Ch code reconf. (O,UE) & Timing adjust. (O,UE)
At mode transition within SHO region	Not occur	Not occur	Not occur	Scr/Ch code reconf. (O,T,UE) & Timing adjust. (T,UE)

* In candidate 4, the mode transition is assumed to occur within SHO region. If it occurs at the boundary, Candidate 4 is the same as Candidate 3.

The proposed soft handover candidates 3) and 4) need the timing adjustment and code assignment process, in order to operate in USTS mode at target Node B. The reason why both timing adjustment and code assignment are operated is to get performance gains from orthogonality by USTS. The criterion that makes the reconfiguration process be operated is different in 3) and 4). In candidate 3), it is whether UE exists inside handover region or out of the region. However, the reconfiguration process occurs inside the soft handover region in 4). Even though the detailed procedures are beyond WG1's interests, UTRAN can select the proper timing for the reconfiguration process, because it selects the better frame between the two possible candidates within RNC, or knows the number of UEs in USTS mode at each Node B and pilot signal power of each UE from the reception of the measurement. The candidate 3) can provide more reliable USTS link at target Node B, because the UE obtains better channel conditions during handover process. As well, there would be more interference of a UE penetrating into target Node B without being timing alignment by USTS in 3) comparing with 4). That is because the timing change of target Node B always occurs outside the handover region. Such effects are more important in three-way soft handover. Figure 6.1 shows three-cell layout for candidate 3). When a UE gets out of USTS area with Node B #1, it should be decided whether USTS would be operated with Node B #2 or Node B #3 in soft handover region. In addition, non-USTS link should be set-up with the other Node B to keep the soft handover. Therefore, the reconfiguration process needs for candidate 3) in three-way soft handover operation like candidate 4). As well, there exist more chances to operate the soft handover in 4) for three-cell situation than in 3), which can reduce the interference to target Node Bs and improve the link performances. Ping-pong effects can be reduced by hysteresis as a similar manner with the handover method in Release 99. As explained above, the candidate 4) may give more reliable performance. However, complexity is expected to increase because the reconfiguration process needs to happen at original Node B. If USTS to non-USTS transition in original Node B does not happen, then the candidate 4) is the same with 3) except the point that handover takes place inside the handover region. Thus, the candidate 4) is a more general approach of soft handover for USTS.

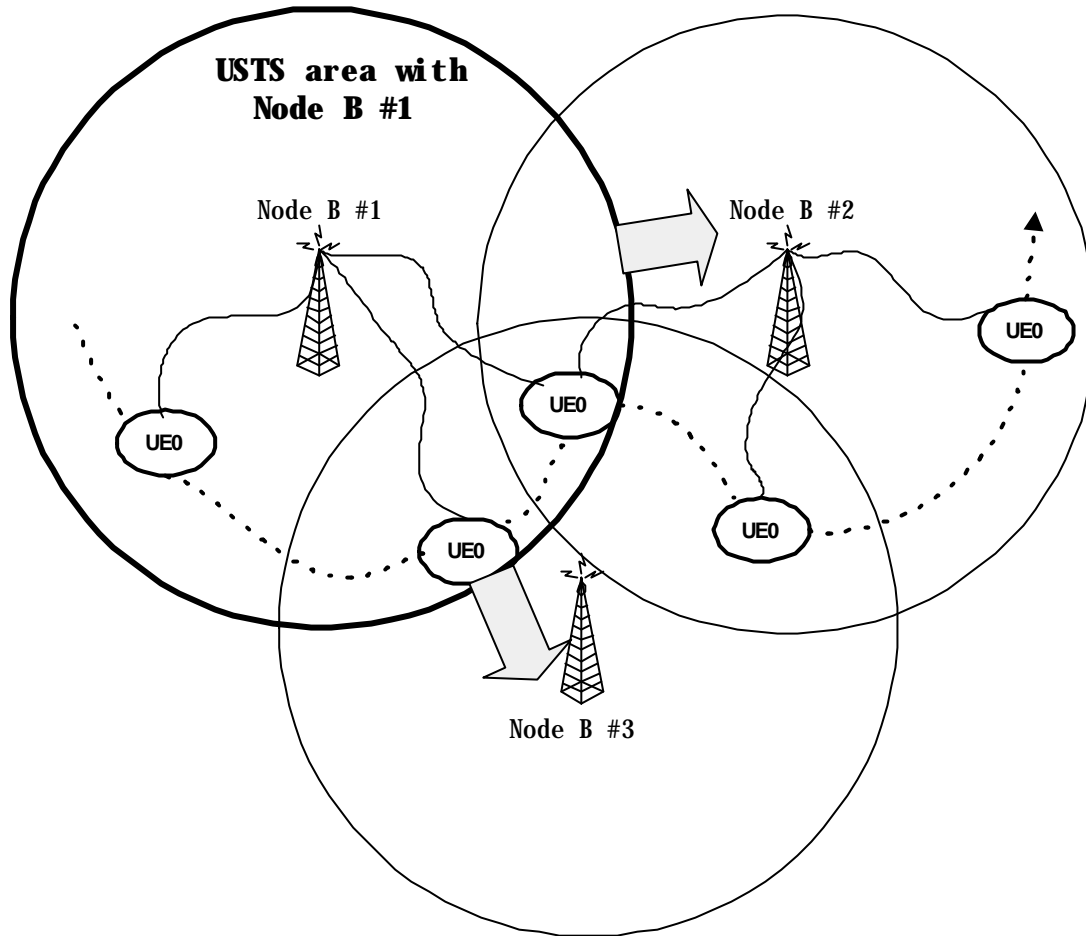

Figure 6.1. Three-way soft handover situation for candidate 3.

Reference: R1-01-0061, "Comparison of soft handover scheme for USTS", LGE.

6.5. Impact on closed loop power control

If the transmission time of UE can be adjusted at the initial synchronisation phase and during the call (DL timing stays the same), then UL/DL relative timing does not stay fixed. This relative timing is up to T_{ref} and the UE capability (CLPC processing budget). An appropriate value for T_{ref} can be found so that UL/DL relative timing is kept within the range of $T_0 \pm T_{ref}$ chips. This is the case when T_{ref} is set to be the maximum one-way propagation delay and CLPC delay can be kept at 1 slot for $T_{ref} < 148$ chips (this corresponds to about 11.5 km cell radius with a chip rate of 3.84 Mcps). And according to the current specifications, during soft handover, UL/DL timing is within $T_0 \pm 148$ chips without USTS. With USTS, the DL arrival timings from the cells in Active set remain unchanged and only the UL transmission timing varies and accordingly, the range can be shifted so that the DL arrival times occur $T_0 \pm 148$ chips earlier than the UL transmission time. Or, the power control may take more than one slot time. Also as the amount of timing adjustment varies faster in a wider range, the DL timing adjustment may occur more frequently. The trade-off between the performance degradation due to longer power control loop delay and the signalling load to adjust the DL timing needs to be taken into account.

USTS affects the performance of CLPC because TAB commands punctures TPC bits at a timing control rate. However, compared to the attainable performance gain, performance degradation due to puncturing, for example, one out of 30 TPC bits is much smaller. This is because USTS can mitigate the effect of imperfect power control by preserving orthogonal property among channelisation codes.

7. Impacts to other WGs

7.1.WG2

7.1.1.RRC layer

RRC Connection Request Message needs to include **USTS indicator** to notify whether the UE supports USTS or not.

The following RRC messages should include some information related to USTS such as scrambling code, channelization code, and initial synchronization information.

- RRC Connection Setup Message (RRC Connection Re-establishment Message)
- Radio Bearer Setup Message (Radio Bearer Reconfiguration Message)
- Transport Channel Re-configuration
- Physical Channel Reconfiguration

7.1.2.RLC Layer

- No impact on RLC layer

7.1.3.MAC Layer

- No impact on MAC layer

7.1.4.Interface between RRC and PHY layer

Inter-layer interface primitive between RRC layer and physical layer should include some parameters for USTS

- CPHY-RL-Modify-REQ
- CPHY-RL-Setup-REQ

7.2.WG3

TR 25.839

7.3.WG4

FFS

8. Backward compatibility

Since the USTS capability is negotiated during call-setup phase, a UE based on Release 99/4 can be used in Release 5 UTRAN with USTS capability without any impact. And similarly, a UE based on Release 5 with USTS capability can be used in Release 99/4 UTRAN without any impact by the same reason.

Consequently, the backward compatibility is guaranteed with USTS in Release 5.

Annex A: Change history

Change history							
Date	TSG #	TSG Doc.	CR	Rev	Subject/Comment	Old	New

Document history		
Date	Version	Comment
November 21, 2000	0.0.0	First draft
January 15, 2000	0.0.1	General description of USTS, more description of four soft handover candidates, and discussion on complexity issue added.
January 19, 2001	0.0.2	Timing update rate changed
January 19, 2001	0.1.0	Minor editorial changes
February 28, 2001	0.2.0	Further descriptions on soft handover candidates added.
Editor for 3G TR 25.854 is:		
Duk Kyung Kim SK Telecom Tel. : +82 31 710 5167 Fax : +82 31 710 5098 Email : kdk@sktelecom.com		
This document is written in Microsoft Word version 98.		