

Source: Editor

Title: I3.02 – Manifestations of Handover and SRNS Relocation v.0.1.0

Document for: Approval

Agenda Item:

TR I3.02 V<0.1.0> (<1999-04>)

Technical Specification

**3rd Generation Partnership Project (3GPP);
Technical Specification Group (TSG) RAN;**

Manifestations of Handover and SRNS Relocation

3GPP

Reference

<Workitem> (<Shortfilename>.PDF)

Keywords

<keyword[, keyword]>

3GPP

Postal address

Office address

Internet

secretariat@3gpp.org
Individual copies of this deliverable
can be downloaded from
<http://www.3gpp.org>

Copyright Notification

No part may be reproduced except as authorized by written permission.
The copyright and the foregoing restriction extend to reproduction in all media.

©
All rights reserved.

Contents

Intellectual Property Rights	6
Foreword	6
Introduction.....	6
1 Scope	7
2 References	7
3 Definitions, symbols and abbreviations	7
3.1 Definitions.....	7
3.2 Symbols.....	7
3.3 Abbreviations.....	7
4 General Aspects.....	7
5 Manifestations of Handover	8
5.1 Scenario 1: Intra Node B.....	8
5.1.1 Scenario 1a: Intra Node B (intra Cell).....	8
5.1.2 Scenario 1b: Intra Node B (inter Cell)	8
5.2 Scenario 2: Inter Node B.....	9
5.2.1 Scenario 2a: Inter Node B (Intra RNS)	9
5.2.2 Scenario 2b: Inter Node B (Inter RNS, with Iur).....	10
5.2.3 Scenario 2c: Inter Node B (Inter RNS, without Iur).....	11
5.3 Scenarios 3 & 4.....	11
5.4 Scenario 5: Inter URAN (different URAN types).....	12
5.5 Scenario 6: Inter CN (same URAN types)	12
5.6 Scenario 7: Inter CN (different URAN types).....	12
5.7 Scenario 8:	13
5.8 Scenario 9: Inter CN (different CN/URAN types).....	13
5.9 Scenario 10:	14
5.10 Scenario 11: Intra CN (UTRAN/GSM)	14
6 Applicability of the Scenarios	14
6.1 TDD/FDD Modes	14
6.2 Public/Private Domains.....	14
History	15

Intellectual Property Rights

Foreword

This Technical Report has been produced by the 3rd Generation Partnership Project, Technical Specification Group RAN.

The contents of this TR may be subject to continuing work within the 3GPP and may change following formal TSG approval. Should the TSG modify the contents of this TR, it will be re-released with an identifying change of release date and an increase in version number as follows:

Version m.t.e

where:

- m indicates [major version number]
- x the second digit is incremented for all changes of substance, i.e. technical enhancements, corrections, updates, etc.
- y the third digit is incremented when editorial only changes have been incorporated into the specification.

Introduction

[Editor's note: 23:10 will need to be replaced with whatever it will now be called in 3GPP].

This paper attempts to map the various manifestations of handover in UMTS 23.10 (version 0.6.0) onto the proposed UTRAN architecture. There are several reasons for doing this:

- to ensure that all scenarios have been captured and can be developed
- so that the requirements for the UTRAN/CN entities and interfaces can be defined
- to raise and discuss issues concerning the architecture

Some of the scenarios from 23.10 have been split to provide more detail.

1 Scope

The present document identifies a number of handover and SRNS Relocation scenarios for UTRAN. It is intended to reflect and clarify the requirements on UTRAN, and to assist in the development of procedures and capabilities.

2 References

The following documents contain provisions which, through reference in this text, constitute provisions of the present document.

- References are either specific (identified by date of publication, edition number, version number, etc.) or non-specific.
 - For a specific reference, subsequent revisions do not apply.
 - For a non-specific reference, the latest version applies.
 - A non-specific reference to an ETS shall also be taken to refer to later versions published as an EN with the same number.
-

3 Definitions, symbols and abbreviations

3.1 Definitions

For the purposes of the present document, the following terms and definitions apply.

Handover the transfer of a user's connection from one radio channel to another (can be same or different cell).

SRNS Relocation the change of Iu instance. It should be noted that SRNS Relocation was previously known as Streamlining.

[editor's note: an improved definition of handover is for further study]

3.2 Symbols

For the purposes of the present document, the following symbols apply:

3.3 Abbreviations

For the purposes of the present document, the following abbreviations apply:

4 General Aspects

The scenarios show the relationship between radio interface mobility with Iu interface mobility.

It should be noted that in all scenarios where the UE is connected to UTRAN, the connection can use Dedicated or Common channels, in either FDD or TDD mode. In CCH state, only hard handover is possible, while in DCH state both hard and soft handover may be possible (depending on scenario).

For handover between FDD and TDD modes, only hard handover is possible.

Throughout the paper handovers are shown in both directions (i.e. the scenarios are symmetric); it is for further study whether this is desirable and/or practical.

It is assumed that support of inter-operator soft handover is not required.

[editor's notes: UMTS 23.10 also classifies handovers in terms of where the decision is taken, whether the target cell has prior knowledge and whether there is an anchor point. Clearly, these concepts and the requirements imposed by macrodiversity/soft handover also need to be included in the discussions.]

Handover and SRNS relocation discussions should not only consider the radio aspects, but also related issues such as transcoder location, handover of both stream and packet data services, fax services, QoS requirements, resource availability/negotiation, group calls, local services and VHE. In addition, backward compatibility with GSM should be considered.]

5 Manifestations of Handover

5.1 Scenario 1: Intra Node B

5.1.1 Scenario 1a: Intra Node B (intra Cell)

Scenario 1a covers the case where the mobile does not change cell, but changes frequency/code. This scenario shall be supported by the UTRAN. Steps (i) & (ii) show the situation before and after.

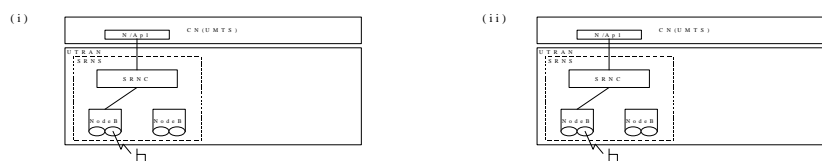

Scenario 1a: Intra Node B (Intra Cell)

5.1.2 Scenario 1b: Intra Node B (inter Cell)

Scenario 1b is the other case of the intra Node B handover, where the radio session is handed from one cell to another, both within the same Node B. In the case of a dual mode Node B, intra Node B handover may include a change of mode (TDD \leftrightarrow FDD). This scenario shall be supported by the UTRAN, for both hard and soft handover. For hard handover, step (ii) is omitted.

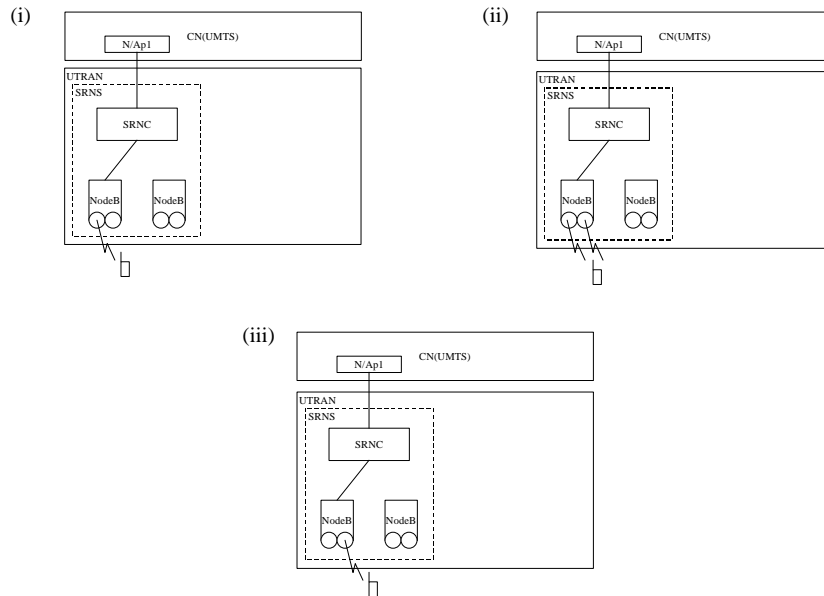

Scenario 1b: Intra Node B (Inter Cell)

5.2 Scenario 2: Inter Node B

5.2.1 Scenario 2a: Inter Node B (Intra RNS)

Scenario 2a involves a change of Node B, so in a soft handover situation the uplink “combining” (or selection) occurs at the RNC. In the case of a dual mode RNC, intra RNS handover may include a change of mode (TDD \leftrightarrow FDD). Again, this shall be supported by the UTRAN for both soft and hard handover cases. For hard handover, step (ii) is omitted.

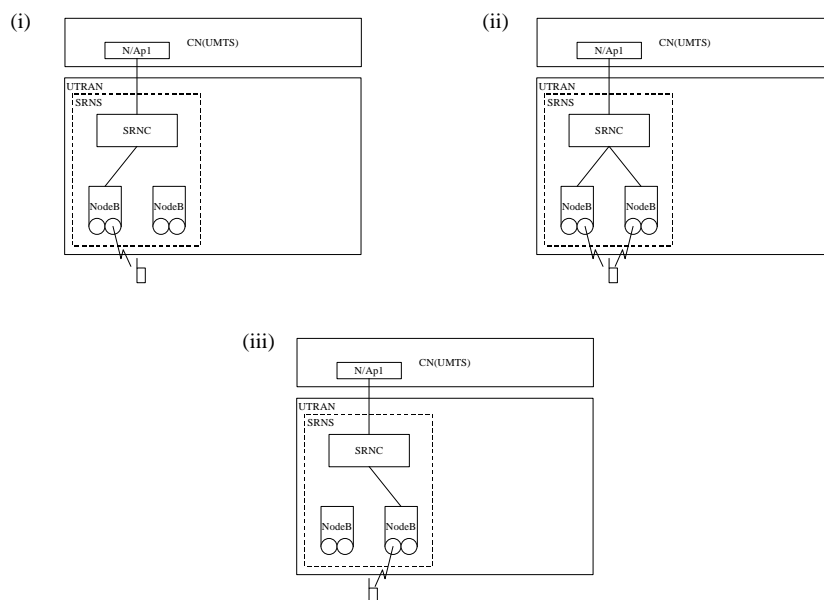

Scenario 2a: Inter Node B (Intra RNS)

5.2.2 Scenario 2b: Inter Node B (Inter RNS, with Iur)

In Scenario 2b, the handover still occurs within the UTRAN, but is now between cells under the control of different RNCs; it is for further study (in SMG12) what the implications of the access points (N/Ap) being in the same or different core network nodes are. The scenario can be split into two phases – handover and SRNS relocation. For a particular UE, the SRNS Relocation phase is optional. It may be executed at any time by UTRAN (SRNC) in the case of a UE moving to a cell which belongs to a different RNC from the current SRNC.

Inter RNS hard handover may include a change of mode (FDD<->TDD). It is for further study whether the RNCs need to be dual mode.

This scenario will be supported by the UTRAN as both soft and hard handover.

In the first set of figures (soft handover), steps (i) & (ii) show the UE entering the macrodiversity state; step (iii) shows the UE connected to a DRNC only. Either step (ii) or step (iii) can be the starting point for SRNS relocation (see below).

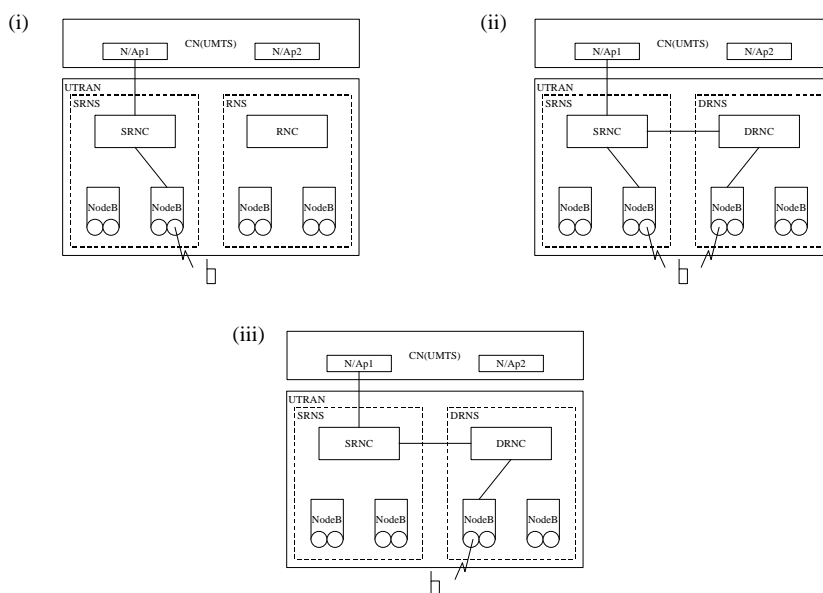

Scenario 2b: Inter RNS
Soft Handover

In the hard handover figures, steps (i) & (ii) show the handover. Step (ii) is the starting point for any subsequent SRNS relocation (see below).

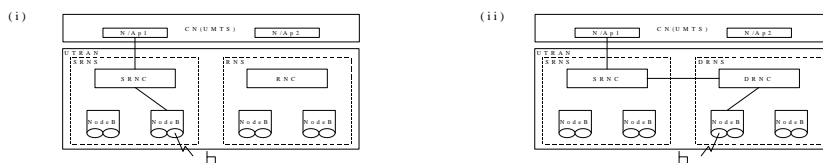

Scenario 2b: Inter RNS
Hard Handover

The SRNS relocation phase can either be initiated when the UE is only connected through one or more drift RNCs (i), or when the connection is also using radio resources directly controlled by the Serving RNC (iii). Steps (ii) and (iv) show the situation after the SRNS Relocation has occurred.

[Editor's note – short term transient states are not shown]

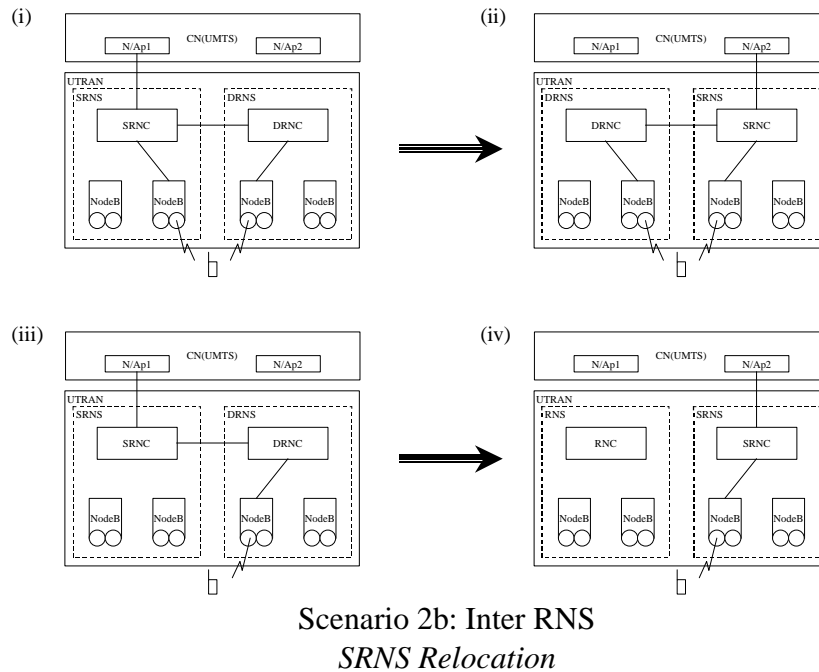

5.2.3 Scenario 2c: Inter Node B (Inter RNS, without Iur)

Scenario 2c shows the case where there is no Iur interface between the RNSs. This scenario will be supported by UTRAN as hard handover only and may include a change of mode (TDD \leftrightarrow FDD). Steps (i) & (ii) show the situation before and after.

[Editor's note: whether this may also represent public/private handover is for further study.]

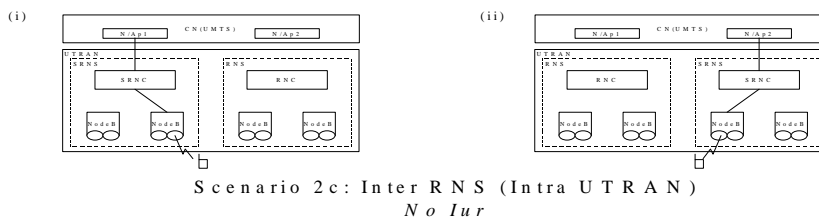

5.3 Scenarios 3 & 4

Scenarios 3 and 4 in 23:10 are defined as follows:

- 3) inter-URAN handover (without change of CN access point)
- 4) intra-CN handover with same URAN type

As there is currently no requirement for the support of multiple access networks (of the same type) from one core network, these scenarios are inconsistent with the UMTS requirements and so have been omitted. If the connection of 2 UTRANs to one CN becomes a requirement, then these scenarios may need to be included.

5.4 Scenario 5: Inter UTRAN (different UTRAN types)

Scenario 5 is for handover between a UTRAN and another type of radio access (e.g. BRAN) both connected to a UMTS core network. This scenario is FFS; it is FFS whether it will be supported by UTRAN in UMTS Phase 1. If supported, it will be as a hard handover. Steps (i) & (ii) show handover from UTRAN. Steps (iii) & (iv) show handover to UTRAN.

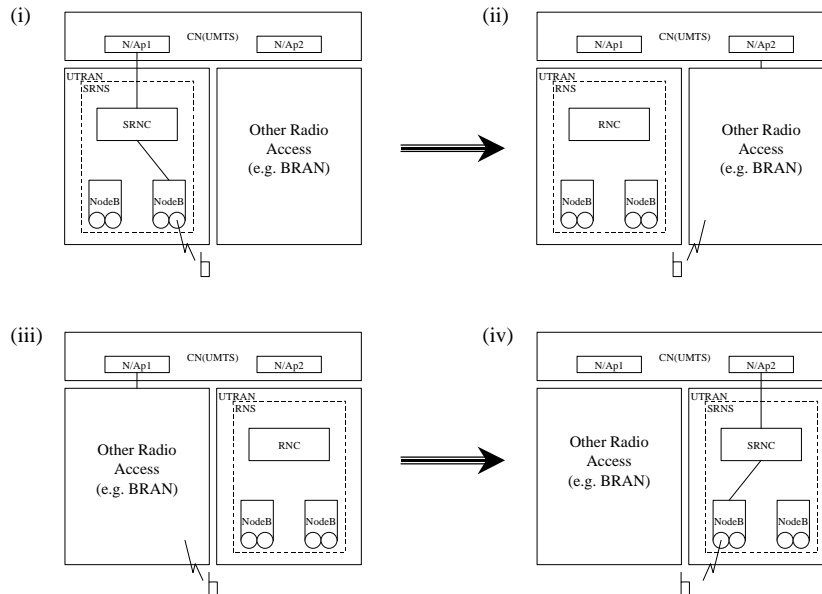

Scenario 5: Inter UTRAN
Different UTRAN Types

5.5 Scenario 6: Inter CN (same UTRAN types)

Scenario 6 shows the case where the handover is between two UTRANs that are connected to different UMTS core networks. An example of this would be inter-operator handover. This scenario will be supported by UTRAN as hard handover only and may involve a change of mode (FDD \leftrightarrow TDD). Steps (i) & (ii) show the situation before and after.

[editor's note: the interface between the CNs is outside the scope of SMG2-ARC, and is only included for completeness].

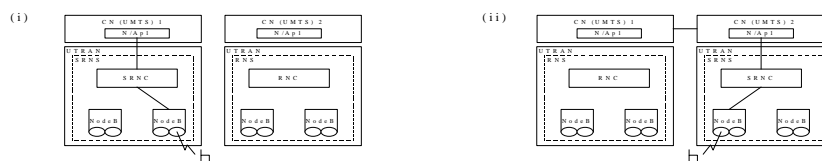

Scenario 6: Inter CN
Same UTRAN/CN Types

5.6 Scenario 7: Inter CN (different UTRAN types)

Scenario 7 is a combination of the previous two, with the handover between a UTRAN (connected to one UMTS CN) and another radio access (connected to a different UMTS CN; the interface is FFS in SMG12). This scenario is FFS; it is FFS whether it will be supported by UTRAN in UMTS Phase 1. If supported, it will be as a hard handover only. Steps (i) & (ii) show handover from UTRAN. Steps (iii) & (iv) show handover to UTRAN.

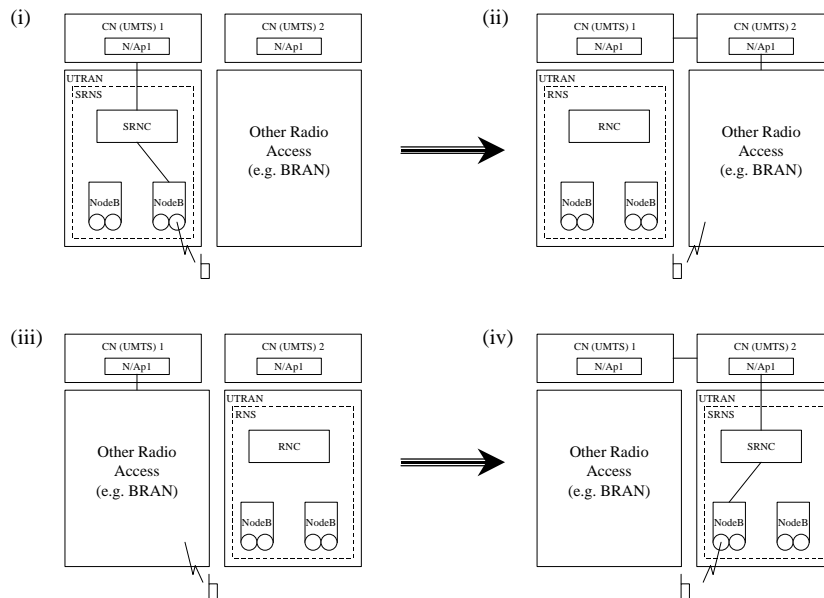

Scenario 7: Inter CN
Different URAN Types

5.7 Scenario 8:

For Further Study.

5.8 Scenario 9: Inter CN (different CN/URAN types)

Scenario 9 shows the case of UMTS-GSM handover. More generally this scenario is for inter core network handover with different URAN types. It will be supported by UTRAN as a hard handover only. It is assumed that there will be no direct UTRAN-BSS interface. Steps (i) & (ii) show handover from UTRAN. Steps (iii) & (iv) show handover to UTRAN.

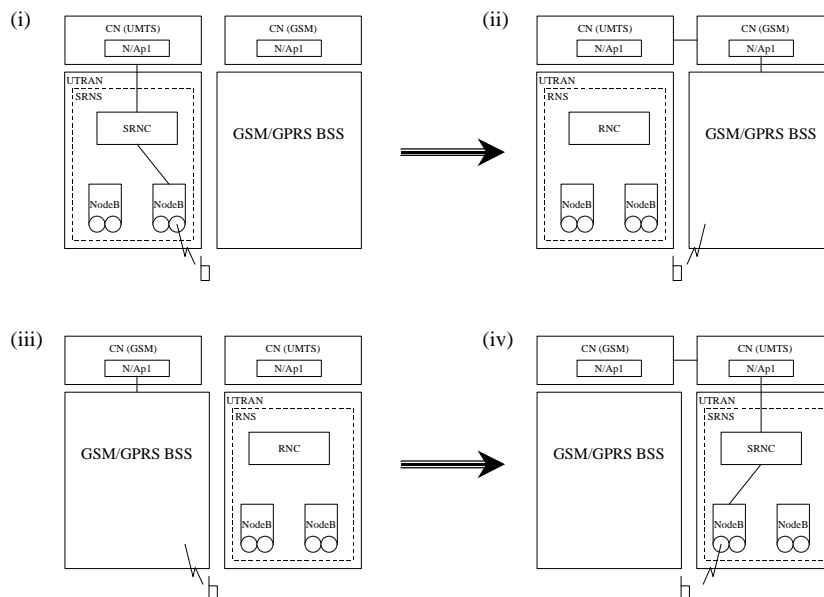

Scenario 9: Inter CN
Different CN/URAN Types

5.9 Scenario 10:

For Further Study.

5.10 Scenario 11: Intra CN (UTRAN/GSM)

Scenario 11 shows handover between UTRAN and a GSM BSS. This will be supported by the UTRAN as hard handover only. It is assumed that there will be no direct UTRAN-BSS interface, so handover between GSM BSS and UTRAN is supported by switching in the core network. Steps (i) & (ii) show handover from UTRAN. Steps (iii) & (iv) show handover to UTRAN.

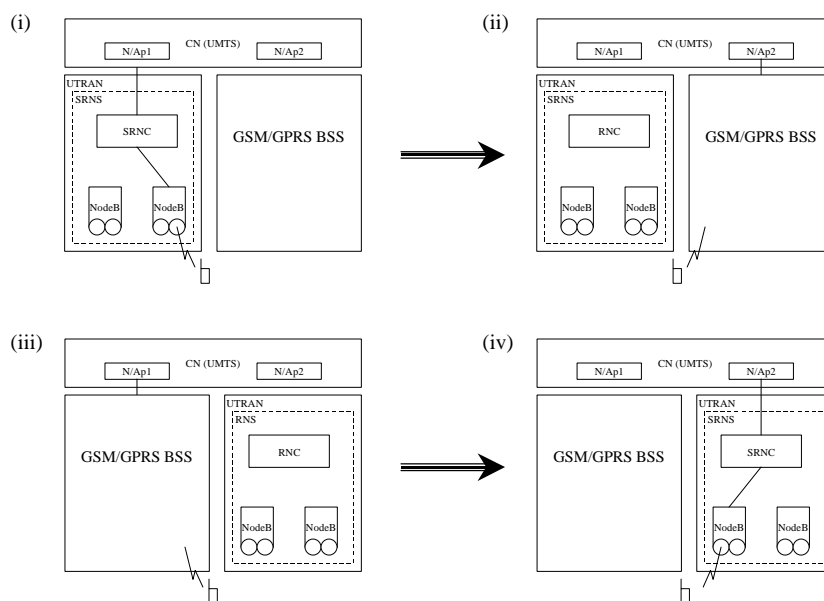

Scenario 11: Intra CN
UTRAN/GSM

6 Applicability of the Scenarios

6.1 TDD/FDD Modes

Handover between TDD and FDD mode (and vice versa) is a special case of the inter-cell, intra UTRAN or inter UTRAN hard handover scenarios shown above whenever the cells involved are of different modes (FDD or TDD). So, these mixed mode scenarios are already included in the scenarios 1 to 6 above.

6.2 Public/Private Domains

The mapping of public and private domains onto the scenarios is for further study.

History

Document history		
v 0.0.1	1999-02	Initial Skeleton
V0.0.2	1999-02	Skeleton Populated from ETSI document; change marks refer to changes agreed at the last meeting. There are no editorial changes to the ETSI text, other than re-organisation to fit the skeleton.
V0.0.3	1999-03	Inserted editor's proposed text for Scope chapter.
V0.1.0	1999-04	Approved by WG3
Editor for 3GPP RAN I3:01 is:		
Richard Townend BT Tel.: +44 1473 605 429 Fax : +44 1473 623 683 Email : richard.townend@bt.com		
This document is written in Microsoft Word version 7/97.		