

TS RAN 25.415 V1.0.24 (1999-098)

Technical Specification

**3rd Generation Partnership Project (3GPP);
Technical Specification Group (TSG) RAN;
Working Group 3 (WG3);**

Iu Interface CN-UTRAN User Plane Protocol

UMTS 25.415



The present document has been developed within the 3rd Generation Partnership Project (3GPPTM) and may be further elaborated for the purposes of 3GPP. The present document has not been subject to any approval process by the 3GPP Organisational Partners and shall not be implemented. This Specification is provided for future development work within 3GPP only. The Organisational Partners accept no liability for any use of this Specification. Specifications and reports for implementation of the 3GPPTM system should be obtained via the 3GPP Organisational Partners' Publications Offices.

UMTS 25.415

(25.415.PDF)

Keywords

Digital cellular telecommunications system,
Universal Mobile Telecommunication System
(UMTS), UTRAN, CN, Iu

3GPP

Postal address

Office address

Internet

secretariat@3gpp.org
Individual copies of this deliverable
can be downloaded from
<http://www.3gpp.org>

Copyright Notification

No part may be reproduced except as authorized by written permission.
The copyright and the foregoing restriction extend to reproduction in all media.

©
All rights reserved.

Contents

Intellectual Property Rights	97
Foreword	97
1 Scope	108
2 References	108
3 Definitions, symbols and abbreviations	108
3.1 Definitions.....	108
3.2 Abbreviations.....	119
3.3 Concepts.....	119
4 General.....	1240
4.1 General aspects	1240
4.2 Operational and Functional aspects.....	1340
4.2.1 Iu UP protocol modes of operation	1340
4.2.2 Transparent mode (TrM).....	1344
4.2.3 Support modes.....	1344
5 Transparent mode	1442
5.1 General.....	1442
5.1.1 Operation of the Iu UP in Transparent mode.....	1442
5.1.2 Interfaces of the Iu UP protocol layer in Transparent mode.....	1442
5.2 Iu UP Protocol layer Services in Transparent mode	1543
5.3 Services Expected from the UP Data Transport layer.....	1543
5.4 Elements for Iu UP communication in Transparent mode	1543
5.4.1 Frames Format for transparent	1543
6 Support modes	1543
6.1 General.....	1543
6.1.1 Operation of the Iu UP in Support mode.....	1543
6.1.2 Interfaces of the Iu UP protocol layer in Support mode.....	1543
6.2 Iu UP Protocol layer Services in Support mode.....	1644
6.3 Services Expected from the UP Data Transport layer.....	1644
6.4 Functions of the Iu UP Protocol Layer in Support mode	1644
6.4.1 Functional model of the Iu UP Protocol Layer in Support mode	1644
6.4.2 Frame Handler function.....	1745
6.4.3 Procedure Control functions.....	1745
6.4.4 Non Access Stratum Data Streams specific function(s).....	1745
6.5 Elementary procedures.....	1745
6.5.1 General	1745
6.5.2 Transfer of User Data procedure	1846
6.5.2.1 Successful operation	1846
6.5.2.2 Unsuccessful operation	1846
6.5.3 Initialisation procedure.....	1947
6.5.3.1 Successful operation	1947
6.5.3.2 Unsuccessful operation	2048
6.5.4 Rate Control procedure	2148
6.5.5 Time Alignment procedure (FFS)	2149
6.5.6 Handling of Abnormal Event procedure.....	2149
6.5.7 Frame Classification.....	2149
6.6 Elements for Iu UP communication in Support mode.....	2149
6.6.1 Frames Format for predefined size SDUs.....	2149
6.6.1.1 PDU Type 0.....	2149
6.6.2 Frames Format for variable size SDUs.....	2220
6.6.3 Frames content definition	2220
6.6.3.1 Frame Number	2220
6.6.3.2 PDU Type.....	2220

6.6.3.3	RAB sub-Flow Combination Indicator (RFCI).....	2220
6.6.3.4	PCP (Procedure Control Part Presence indicator)	2220
6.6.3.5	Procedure Control bitmap.....	2220
6.6.3.6	Procedure Control Fields	2324
6.6.3.7	General	2324
6.6.3.8	Initialization Control Field.....	2324
6.6.3.9	Iu UP Frame Header Check Sum.....	2324
6.6.3.10	Iu UP Frame Payload Check Sum.....	2324
6.6.3.11	Iu UP Payload part.....	2324
6.6.4	Frames coding	2324
6.6.5	Timers	2324
6.7	Handling of unknown, unforeseen and erroneous protocol data	2324
7	Communication Primitives for the Iu UP protocol layer.....	2324
7.1	Modelling Principle	2324
7.2	Primitives towards the upper layers at the RNL SAP.....	2422
7.2.1	General.....	2422
7.2.2	Iu-UP-DATA-REQUEST.....	2523
7.2.3	Iu-UP-DATA-INDICATION.....	2624
7.2.4	Iu-UP-STATUS-REQUEST.....	2624
7.2.5	Iu-UP-STATUS-INDICATION.....	2624
7.2.6	Iu-UP-UNIT-DATA-REQUEST.....	2624
7.2.7	Iu-UP-UNIT-DATA-INDICATION	2624
7.3	Primitives towards the transport layers at TNL SAP	2725
7.3.1	General	2725
7.3.2	Primitives at the TNL-SAP with ATM/AAL2 Transport layer	2725
7.3.3	AAL2 Service Primitives used by the Iu UP protocol.....	2725
7.3.4	Primitives at the TNL-SAP with GTP-U Transport Layer	2725
7.3.5	Generic Service Primitives used by the Iu UP protocol	2825
8	Annex A (Informative): Illustration of usage of RFCI for AMR speech RAB.....	2927
9	Annex B (Informative) Document Stability Assessment Table	3129
10	History	3129
Intellectual Property Rights		6
Foreword.....		6
1	Scope	7
2	References	7
3	Definitions, symbols and abbreviations	7
3.1	Definitions.....	7
3.2	Abbreviations.....	8
3.3	Concepts.....	8
4	General.....	9
4.1	General aspects	9
4.2	Operational and Functional aspects.....	9
4.2.1	Iu UP protocol modes of operation	9
4.2.2	Transparent mode (TrM).....	10
4.2.3	Support modes.....	10
5	Transparent mode	11
5.1	General.....	11
5.1.1	Operation of the Iu UP in Transparent mode.....	11
5.1.2	Interfaces of the Iu UP protocol layer in Transparent mode.....	11
5.2	Iu UP Protocol layer Services in Transparent mode	12
5.3	Services Expected from the UP Data Transport layer.....	12
5.4	Elements for Iu UP communication in Transparent mode	12
5.4.1	Frames Format for transparent	12

6	Support modes	12
6.1	General	12
6.1.1	Operation of the Iu UP in Support mode	12
6.1.2	Interfaces of the Iu UP protocol layer in Support mode	12
6.2	Iu UP Protocol layer Services in Support mode	13
6.3	Services Expected from the UP Data Transport layer	13
6.4	Functions of the Iu UP Protocol Layer in Support mode	13
6.4.1	Functional model of the Iu UP Protocol Layer in Support mode	13
6.4.2	Frame Handler function	14
6.4.3	Procedure Control functions	14
6.4.4	Non Access Stratum Data Streams specific function(s)	14
6.5	Elementary procedures	14
6.5.1	General	14
6.5.2	Transfer of User Data procedure	14
6.5.3	Initialisation procedure	14
6.5.4	Rate Control procedure	15
6.5.5	Time Alignment procedure (FFS)	15
6.5.6	Handling of Abnormal Event procedure	15
6.6	Elements for Iu UP communication in Support mode	16
6.6.1	Frames Format for predefined size SDUs	16
6.6.1.1	PDU Type 0	16
6.6.2	Frames Format for variable size SDUs	17
6.6.3	Frames content definition	17
6.6.4	Frame Number	17
6.6.5	PDU Type	17
6.6.6	RAB sub Flow Combination Indicator (RFCI)	17
6.6.7	PCP (Procedure Control Part Presence indicator)	17
6.6.8	Procedure Control bitmap	17
6.6.9	Procedure Control Fields	18
6.6.9.1	General	18
6.6.9.2	Initialization Control Field	18
6.6.10	Iu UP Frame Header Check Sum	18
6.6.11	Iu UP Frame Payload Check Sum	18
6.6.12	Iu UP Payload part	18
6.6.13	Frames coding	18
6.6.14	Timers	18
6.7	Handling of unknown, unforeseen and erroneous protocol data	18
7	Communication Primitives for the Iu UP protocol layer	18
7.1	Modelling Principle	18
7.2	Primitives towards the upper layers at the RNL SAP	19
7.2.1	General	19
7.2.2	Iu UP DATA REQUEST	20
7.2.3	Iu UP DATA INDICATION	20
7.2.4	Iu UP STATUS REQUEST	20
7.2.5	Iu UP STATUS INDICATION	20
7.2.6	Iu UP UNIT DATA REQUEST	21
7.2.7	Iu UP UNIT DATA INDICATION	21
7.3	Primitives towards the transport layers	21
7.3.1	General	21
7.3.2	Primitives at the AAL SAP: ATM/AAL2 Transport layer	21
7.3.3	AAL2 Service Primitives used by the Iu UP protocol	21
7.3.4	Primitives at the GTP U SAP: GTP Transport Layer	22
8	Annex A (Normative)	3
9	Annex B (Informative): Illustration of usage of RFCI for AMR speech RAB	3
10	Annex C (Informative) Document Stability Assessment Table	5
11	History	6

Intellectual Property Rights

IPRs essential or potentially essential to the present deliverable may have been declared to 3GPP and/or its organizational partners. The information pertaining to these essential IPRs, if any, is publicly available for **3GPP members and non-members, free of charge**. This can be found in the latest version of the 3GPP Technical Report:

[reference tbd.]

Pursuant to the 3GPP Interim IPR Policy, no investigation, including IPR searches, has been carried out by 3GPP. No guarantee can be given as to the existence of other IPRs not referenced in the [tbd.], which are, or may be, or may become, essential to the present document.

Foreword

This Technical Specification has been produced by the 3rd Generation Partnership Project, Technical Specification Group RAN WG3.

The contents of this TS may be subject to continuing work within the 3GPP and may change following formal TSG approval. Should the TSG modify the contents of this TS, it will be re-released with an identifying change of release date and an increase in version number as follows:

Version m.t.e

where:

- m indicates [major version number]
- x the second digit is incremented for all changes of substance, i.e. technical enhancements, corrections, updates, etc.
- y the third digit is incremented when editorial only changes have been incorporated into the specification.

4 Scope

This Technical Specification defines the Radio Network Layer user plane protocol being used over the Iu interface.

2 References

The following documents contain provisions, which, through reference in this text, constitute provisions of the present document.

- References are either specific (identified by date of publication, edition number, version number, etc.) or non-specific.
- For a specific reference, subsequent revisions do not apply.
- For a non-specific reference, the latest version applies.
- A non-specific reference to an ETS shall also be taken to refer to later versions published as an EN with the same number.

- [1] UMTS 25.401, 3rd Generation Partnership Project (3GPP) Technical Specification Group (TSG) RAN; UTRAN Overall Description
- [2] UMTS 25.410, 3rd Generation Partnership Project (3GPP) Technical Specification Group (TSG) RAN; UTRAN Iu interface: general Aspects and Principles
- [3] UMTS 25.413, 3rd Generation Partnership Project (3GPP) Technical Specification Group (TSG) RAN; UTRAN Iu interface RANAP protocol
- [4] UMTS 25.414, 3rd Generation Partnership Project (3GPP) Technical Specification Group (TSG) RAN; Iu Interface Data Transport and Transport Signalling
- [5] UMTS 23.110, 3rd Generation Partnership Project (3GPP) Technical Specification Group (TSG) SSA, UMTS Access Stratum, services and functions
- [6] UMTS 23.121, 3rd Generation Partnership Project (3GPP) Technical Specification Group (TSG) SSA, Architectural requirements for Release 99
- [7] ITU-T Recommendation I.363.2 (1997) - B-ISDN ATM Adaptation Layer type 2 specification
- [8] ITU-T Recommendation I.366.1 (1998) - Segmentation and reassembly service specific convergence sublayer for the AAL type 2
- [9] UTRAN Vocabulary

3 Definitions, symbols and abbreviations

3.1 Definitions

For the purposes of the present document, the following terms and definitions apply.

Non Access Stratum (NAS) Data Streams:

Non Access Stratum Data Streams is a generic term to identify in the CN and the Terminal domains, these data streams exchanged at the Dedicated Service Access Points between the Non Access Stratum and the Access Stratum.

RAB sub-flows: A RAB as defined in [9] is realised by UTRAN through one to several sub-flows. These sub-flows correspond to the NAS service data streams that have QoS characteristics that differ in a predefined manner within a RAB e.g. different reliability classes.

RAB sub-flows characteristics:

1. The sub-flows of a RAB are established and released together at the RAB establishment and release, respectively
2. The sub-flows of a RAB are submitted and delivered together at the RAB SAP
3. The sub-flows of a RAB are carried over the same Iu transmission connection
4. The sub-flows of a RAB are organised in a predefined manner at the RAB SAP and over the Iu interface. The organisation is imposed by the NAS as part of its co-ordination responsibility.

RAB sub-flows numbering (applies to support mode for predefined SDU size only):

1. RAB sub-flows are numbered from 1 to N (N is the number of sub-flows)
2. RAB sub-flow number 1 corresponds to the highest reliability class and the RAB sub-flow number N corresponds to the lowest reliability class.

Note: It is FFS whether numbering of subflows can be based on something else than reliability classes.

3. RAB sub-flows order inside the Iu frame is predefined so that RAB sub-flow number one comes first and the RAB sub-flow number N comes last.

RAB sub-Flow Combination (RFC): A RAB sub-flow combination is defined as an authorised combination of the RAB sub-flows variable attributes (e.g. SDU sizes) of currently valid RAB sub-flows that can be submitted simultaneously to the Iu UP for transmission over Iu interface. Each combination is given by the CN and cannot be altered by the SRNC.

RAB sub-Flow Combination Indicator (RFCI): This indicator uniquely identifies a RAB sub-flow combination for the duration of the Iu UP peer protocol instances i.e. it is valid until the termination of the call or until a new initialisation is performed. Usage of RFCI applies only to Iu UP protocol operated in support mode for predefined SDU size.

Principles related to RFCI allocation and initialization procedure: :

1. RFCI value is present in every Iu user frame
2. In the Initialization procedure in Iu UP, the size of every RAB sub-flow SDU for each RFCI is signalled

3.2 Abbreviations

AMR:	Adaptive Multi-Rate codec
AS:	Access Stratum
CN:	Core Network
NAS:	Non Access Stratum
QoS:	Quality of Service
PDU:	Protocol Data Unit
PCE:	Procedure Control Extension
PME:	Procedure Control Bitmap Extension
RAB:	Radio Access Bearer
RANAP:	Radio Access Network Application Part
RFC:	RAB sub Flow Combination
RFCI:	RFC Indicator
RNL:	Radio Network Layer
<u>SAP:</u>	<u>Service Access Point</u>
SMpSDU:	Support Mode for predefined SDU size
SMvSDU:	Support for variable SDU size
<u>TFO:</u>	<u>Tandem Free Operation</u>
TNL:	Transport Network Layer
<u>TrFO:</u>	<u>Transcoder Free Operation</u>
TrM:	Transparent Mode
UP:	User Plane

4.3 Concepts

Iu UP mode of operation:

One objective of the Iu User Plane (UP) protocol is to remain independent of the CN domain (Circuit Switched or Packet Switched) and to have limited or no dependency with the Transport Network Layer. Meeting this objective provides the flexibility to evolve services regardless of the CN domain and to migrate services across CN domains.

The Iu UP protocol is therefore defined with modes of operation that can be activated on a RAB basis rather than on a CN domain basis or (tele)service basis. The Iu UP mode of operation determines if and which set of features shall be provided to meet e.g. the RAB QoS requirements.

Iu UP protocol PDU Type:

The Iu UP protocol PDU Types are defined for a given Iu UP mode of operation. An Iu UP PDU Type represents a defined structure of an Iu UP protocol frame. For instance, a frame made of a Frame Control part and a Frame Payload part would be specified as a certain PDU type valid for a given Iu UP mode of operation.

4General

4.1General aspects

The Iu UP protocol is located in the User plane of the Radio Network layer over the Iu interface: the Iu UP protocol layer.

The Iu UP protocol is used to convey user data associated to Radio Access Bearers.

One Iu UP protocol instance is associated to one RAB and one RAB only. If several RABs are established towards one given UE, then these RABs make use of several Iu UP protocol instances.

Iu UP protocol instances exist at Iu access point as defined [2] i.e. at CN and UTRAN. Whenever a RAB requires transfer of user data in the Iu UP, an Iu UP protocol instance exists at each Iu interface access points. These Iu UP protocol instances are established, relocated and release together with the associated RAB.

Whether these peer protocol instances perform some RAB related function depends on the mode of operation of the Iu UP as defined below.

The following figure illustrates the logical placement of the Iu UP protocol layer and the placement of the Data Streams sources outside of the Access Stratum.

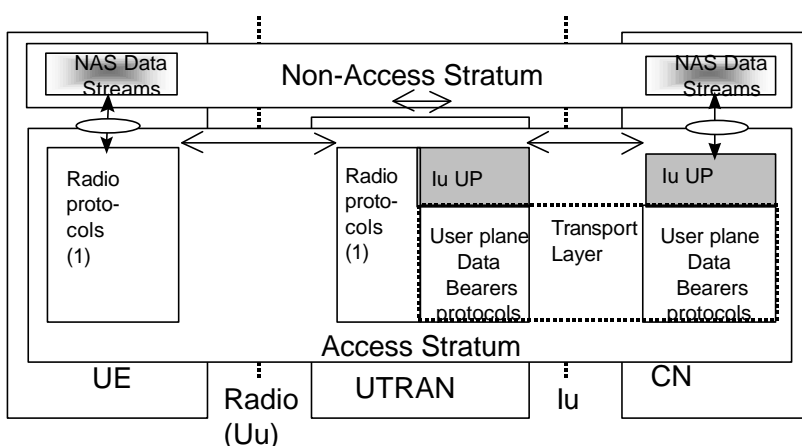

Figure 1: Iu UP protocol layer occurrence in UTRAN overall architecture (User Plane View)

4.2 Operational and Functional aspects

4.2.1 Iu UP protocol modes of operation

The Iu UP protocol operates in mode according to the concept described in earlier section.

Three modes of operation of the protocol are defined:

1. Transparent mode (TrM)
2. Support mode for predefined SDU size (SMpSDU)
3. Support mode for variable SDU size (SMvSDU)

Determination of the Iu UP protocol instance mode of operation is a CN decision taken at RAB establishment based on e.g. the RAB characteristics. It is signalled in the Radio Network layer control plane at RAB assignment and relocation for each RAB. It is internally indicated to the Iu UP protocol layer at user plane establishment.

The choice of a mode is bound to the nature of the associated RAB and cannot be changed unless the RAB is changed.

4.1.2 Transparent mode (TrM)

The transparent mode is intended for those RABs that do not require any particular feature from the Iu UP protocol other than transfer of user data.

The following figure illustrates the transparent mode of operation of the Iu UP protocol layer:

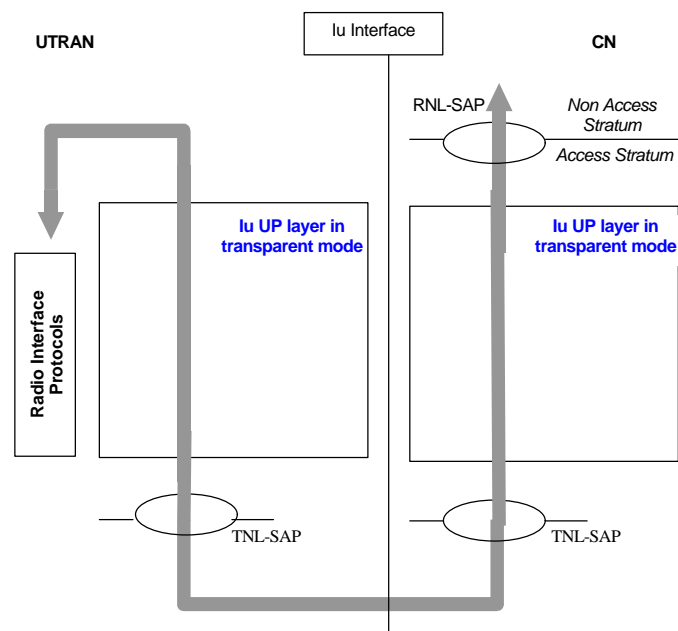

Figure 2: Iu UP protocol layer in transparent occurrence over Iu interface

In this mode, the Iu UP protocol instance does not perform any Iu UP protocol information exchange with its peer over the Iu interface: no Iu frame is sent. The Iu UP protocol layer is crossed through by PDUs being exchanged between upper layers and transport network layer.

For instance, the transfer of GTP-U PDUs or Transparent CS data could utilise the transparent mode of the Iu UP protocol.

4.1.3 Support modes

The support modes are intended for those RABs that do require particular features from the Iu UP protocol in addition to transfer of user data. When operating in a support mode, the peer Iu UP protocol instances exchange Iu UP frames whereas in transparent mode, no Iu UP frames are generated.

The following figure illustrates the functional model of the Iu UP protocol layer in support mode of operation:

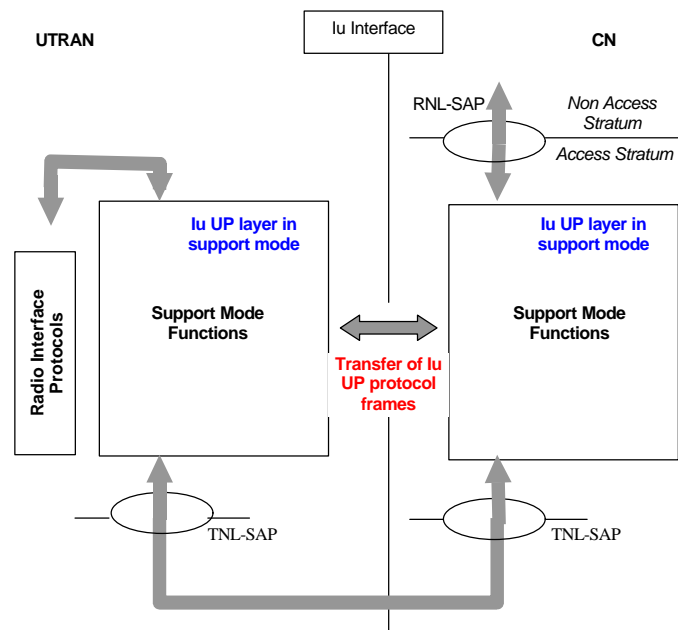

Figure 3: Iu UP protocol layer in support mode occurrence over Iu interface

Some RABs requesting Iu UP protocol support, constrain the Iu UP protocol and possibly the radio interface protocols in specific ways. For instance, certain RABs can have variable predefined rates while other RABs can have totally variable rates within a range, as signalled in the RNL control plane.

The Iu UP support and the usage of the radio interface protocols for these kinds of RABs differ significantly. Consequently, the Iu UP support mode has two variations:

1. Support mode for predefined SDU size (SMpSDU)
2. Support mode for variable SDU size (SMvSDU)

For instance, the transfer of AMR speech PDUs would utilise the support mode for predefined SDU size of the Iu UP protocol because it requires some procedure control functions and some data streams specific functions while the sizes of the user data being transferred can vary in a predefined manner.

The choice of a support mode (for predefined or variable SDU size) is bound to the nature of the associated RAB and cannot be changed unless the RAB is changed.

5.1 Transparent mode

5.1.1 General

5.1.1.1 Operation of the Iu UP in Transparent mode

The Iu UP layer in Transparent mode is present in the Iu User plane for transferring data transparently over the Iu interface.

The two strata communicate through a Service Access Point for Non Access Stratum (NAS) Data Streams transfer.

5.1.2 Interfaces of the Iu UP protocol layer in Transparent mode

The Iu UP protocol layer in Transparent Mode is an empty layer through which NAS Data Streams PDUs are crossing between the Transport Network Layer and upper layers.

4.2 Iu UP Protocol layer Services in Transparent mode

The following functions are needed to support this mode:

- Transfer of user data

5.3 Services Expected from the UP Data Transport layer

The Iu UP protocol layer in Transparent mode expects the following services from the Transport Network Layer:

- Transfer of user data

5.4.1.2 Elements for Iu UP communication in Transparent mode

5.4.1.2.1 Frames Format for transparent

The following shows the format of the PDU crossing the Iu UP protocol layer in transparent mode. This frame is transferred transparently between the Iu UP protocol upper layers and transport network layer (TNL-SAP).

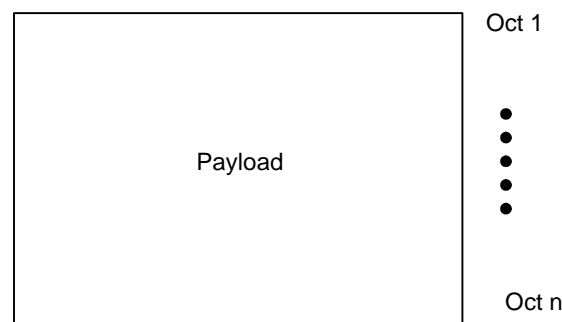

This PDU has a variable length of n octets, whose maximum range depends on the type of user data (e.g. IP packet, UDI CS data etc.). No explicit length indication is visible at the Iu UP protocol layer.

6 Support modes

6.1 General

6.1.1 Operation of the Iu UP in Support mode

The Iu UP protocol layer in Support mode is present for data streams that need frame handling in the UP.

The two strata communicate through a Service Access Point for Non Access Stratum (NAS) Data Streams. There can be one or several data streams towards one Iu UP protocol instance. These non-access stratum data streams need to be coordinated in the Non-Access Stratum.

6.1.2 Interfaces of the Iu UP protocol layer in Support mode

As part of the Access Stratum responsibility, the Iu UP protocol layer in support mode provides the services and functions that are necessary to handle non access stratum data streams. The Iu UP protocol layer in support mode is providing these services to the UP upper layers through a Dedicated Service Access Point used for Information Transfer as specified in [5].

The Iu UP protocol layer in support mode is using services of the Transport layers in order to transfer the Iu UP PDUs over the Iu interface.

4.2 Iu UP Protocol layer Services in Support mode

- **Support mode for predefined SDU size Service**

The following functions are needed to support this mode:

- Transfer of user data
- Initialisation
- Rate Control (FFS)
- Time Alignment (FFS)
- Handling of abnormal event
- [Frame Classification](#)

- **Support mode for variable SDU size Service**

The following functions are needed to support this mode:

- FFS

6.3 Services Expected from the UP Data Transport layer

The Iu UP protocol layer expects the following services from the Transport Network Layer:

- Transfer of user data

6.4 Functions of the Iu UP Protocol Layer in Support mode

6.4.1 Functional model of the Iu UP Protocol Layer in Support mode

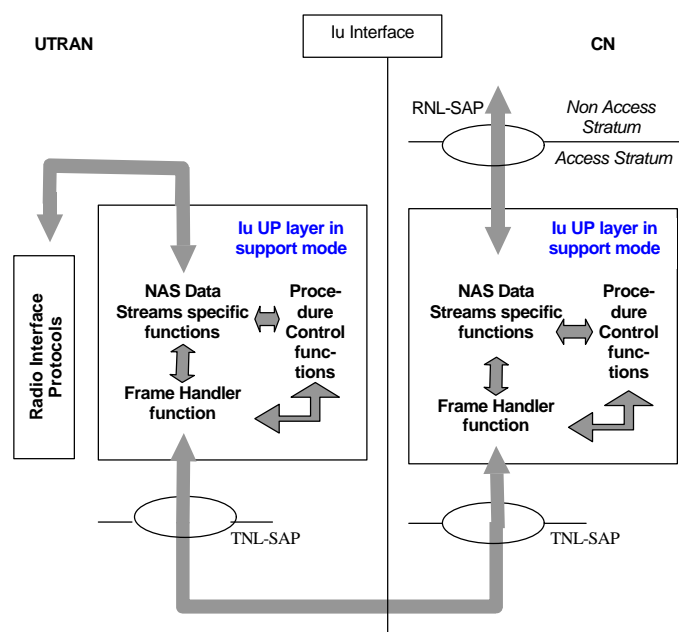

Figure 5: Functional model of the Iu UP protocol layer in Support mode

The Iu UP protocol layer in Support mode is made of three sets of functions:

1. Frame Handler function
2. Procedure Control functions
3. Non Access Stratum Data Streams specific functions.

6.4.2 Frame Handler function

This function is responsible for framing and de-framing the different parts of an Iu UP protocol frame. This function takes the different part of the Iu UP protocol frame and set the control part field to the correct values. It also ensures that the frame control part is semantically correct. This function is responsible for interacting with the Transport layers. This function is also responsible for the CRC check of the Iu UP frame header.

4.1.3 Procedure Control functions

This set of functions offers the control of a number of procedures handled at the Iu UP protocol level. These functions are responsible for the procedure control part of the Iu UP frames.

Namely, these procedures are:

- **Rate Control:** is the procedure which controls over Iu UP the maximum rate among the *RAB Formats (to update)* negotiated for the established RAB service. The function controlling this procedure interacts with functions outside of the Iu UP protocol layer.
- **Initialisation:** is the procedure which controls the exchange of initialisation information that ~~is may be~~ required for ~~operation in support mode for predefined SDU size~~ *certain RAB such as Speech*. Such information can contain the RFCI Set to be used until termination of the connection or until the next initialisation procedure.
- **Time Alignment (FFS):** is the procedure that controls the information exchanged over the Iu related to the sending time of Iu UP frames. The function controlling this procedure interacts with functions outside of the Iu UP protocol layer.
- **Handling of Abnormal Event:** is the procedure that controls the information exchanged over the Iu related to detection of a fault situation. The function controlling this procedure interacts with functions outside of the Iu UP protocol layer.

6.4.4 Non Access Stratum Data Streams specific function(s)

These functions are responsible for a “limited” manipulation” of the payload and the consistency check of the frame number. If a frame loss is detected due a gap in the sequence of the received frame numbers, this shall be reported to the procedure control function. These functions are responsible for the CRC check and calculation of the Iu UP frame payload part.

These functions interact with the upper layers through a SAP by exchanging Iu data stream blocks of Iu UP frame payload.

These functions interact with the procedure control functions.

These functions provide service access to the upper layers for the procedure control functions.

4.5 Elementary procedures

6.5.1 General

It shall be possible to perform any of the control procedures regardless of the user data transmission.

4.1.2 Transfer of User Data procedure

6.5.2.4 Successful operation

The purpose of the transfer of user data procedure is to transfer Iu UP frames between the two Iu UP protocol layers at both ends of the Iu interface. Since an Iu UP instance is associated to a RAB and a RAB only, the user data being transferred only relate to the associated RAB.

The procedure is controlled at both ends of the Iu UP instance i.e. SRNC and the CN.

The transfer of user data procedure is invoked whenever user data for that particular RAB needs to be sent across the Iu interface.

The procedure can only be invoked when the Iu UP protocol layer is in the "Transfer of user data" state.

The procedure is invoked by the Iu UP upper layers upon reception of the upper layer PDU and associated control information: RFCI.

Note: This part needs to be updated with frame classification "In SRNC, the upper layers may deliver a frame classification information together with the RFCI:

The NAS Data streams functions perform, if needed, CRC calculation of the upper layer PDU and passes down to the frame handler together with the RFCI.

The frame handler function retrieves the frame number from its internal memory, format the frame header and frame payload into the appropriate PDU Type and sends the Iu UP frame PDU to the lower layers for transfer across the Iu interface.

Note: This part needs to be updated with time alignment and frame numbers and periodicity of frame sending.

After sending the user data frame, the Iu UP protocol layer remains in the "Transfer of User Data" state.

Upon reception of a user data frame, the Iu UP protocol layer checks the consistency of the Iu UP frame as follows:

- The Frame handler checks the consistency of the frame header. If correct, the frame handler stores the frame number and passes the Iu UP frame payload and associated CRC, if any to the NAS Data Streams functions. The received RFCI is passed to the Procedure Control Function.
- The NAS Data Streams functions check the payload CRC, if any. If the RFCI is correct and matches the Iu UP frame payload as indicated by the Procedure Control functions, the NAS Data Streams forwards to the upper layers RFCI and Iu UP frame payload.

The Iu UP protocol layer remains in the "Transfer of User Data" state.

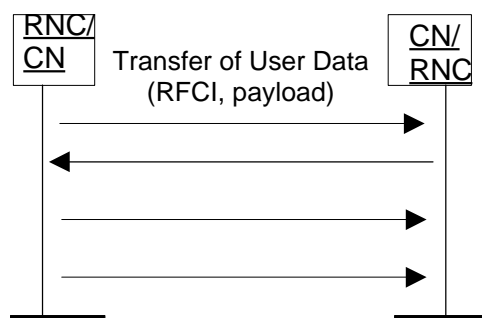

Figure x. Successful Transfers of User Data

4.1.1.2 Unsuccessful operation

If the Iu UP frame carrying the user data is incorrectly formatted or cannot be correctly treated by the receiving Iu UP protocol layer, the Iu UP protocol layer shall either discard the frame or pass it to the upper layers with a frame classification indicating a corrupted frame. This decision is based on configuration data of the Iu UP instance for that

particular RAB (i.e. if the RAB requests delivery of corrupted frame). The Iu UP protocol remains in the “Transfer of User Data” state.

If the Iu UP protocol layer detects a frame loss because of a gap in the received frame number sequence while the frame number does not relate to time (see section Time Alignment), the receiving Iu UP protocol layer shall report to the procedure control function. The Iu UP protocol remains in the “Transfer of User Data” state.

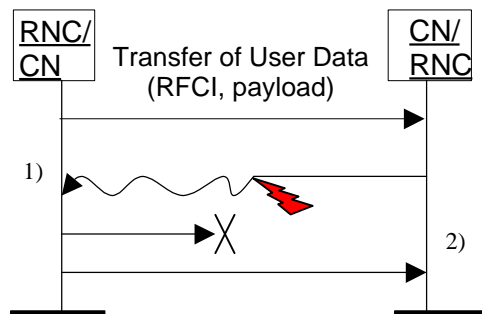

Figure x. Unsuccessful Transfers of User Data: 1) Corrupted Frame, 2) Detection of Frame loss

4.4.3 Initialisation procedure

Note: It is FFS whether this procedure is to be merged with a procedure used in the communication phase.

Successful operation

This procedure is mandatory for RABs using the support mode for predefined SDU size. The purpose of the initialisation procedure is to configure both termination points of the Iu UP with the RFCIs and associated RAB Sub Flows SDU sizes necessary during the transfer of user data phase. Additional parameters may also be passed.

The initialisation procedure is always controlled by the entity in charge of establishing the Radio Network Layer User Plane i.e. SRNC_S.

The initialisation procedure is invoked whenever indicated by the Iu -UP Procedure Control function e.g. as a result of a relocation or at RAB establishment over Iu.

~~This procedure is mandatory for a speech RAB.~~

~~This procedure is only invoked when the Iu UP protocol layer is in the “Initialisation State”. This states is entered each time the initialisation procedure needs to be run and all other Iu UP procedures are suspended until termination of the initialisation procedure. The “Initialisation state” is left at termination of the procedure.~~

Note: Whether this procedure can also be used for CS Data is FFS.

The ~~SRNC_I UP procedure control function~~ allocates an indicator to each RAB sub-Flow Combination (RFCI). The association of indicators to RAB Flow Combinations is valid in the Iu UP until a new initialisation procedure is performed or the connection is terminated.

The procedure control function may also generate additional Iu -UP protocol parameters necessary for the RAB service to operate properly over Iu.

To each RAB sub-Flow combination indicator is associated the size of each RAB sub-Flow SDU of that combination. The list of RAB Flow Combination Indicators and their respective SDU sizes constitutes the RAB sub-Flow Combination set passed over the Iu UP in the initialisation frame i.e. into an appropriate Iu UP PDU Type.

The first RAB sub-Flow Combination proposed in the list of RAB sub-Flow Combination indicates the initial RAB sub-Flow Combination i.e. the first RAB sub-Flow Combination to be used when starting the communication phase i.e. the transfer of user data procedure.

The complete set of information is framed by the Iu UP Frame Handler function and transferred in an Iu UP initialisation frame. If needed, the initialisation frame CRC is calculated and set accordingly in the respective frame field.

After sending the initialisation frame, the Iu UP protocol layer remains in the “Initialisation” state. A supervision timer is started after sending the Iu UP initialisation frame. This timer supervises the reception of the initialisation acknowledgment frame.

Upon reception of an ~~an~~ -frame indicating that an initialisation control procedure is active in the peer Iu-UP entity, the Iu UP protocol layer forwards to the upper layers the RAB sub-Flow Combination set to be used by the Control procedure function. It also stores the RAB sub-Flow Combination set in order to control during the transfer of user data, that the Iu UP payload is correctly formatted (e.g. RFCI matches the expected Iu UP frame payload total length).

If the initialisation frame is correctly formatted and treated by the receiving Iu UP protocol layer, this latter sends an initialisation acknowledgment frame and enters the “Transfer of User data” state.-

Upon reception of an initialisation acknowledgment frame, the Iu UP protocol layer in the SRNC stops the supervision timer and enters the “Transfer of User data” state.

Upon reception of an initialisation negative acknowledgment frame or at timer expiry, the Iu UP protocol layer in the SRNC reset and restart the supervision timer and repeat an initialisation frame. The Iu UP protocol layer remains in the “Initialisation” state. The repetition can be performed n times, n being chosen by the operator (default n=3).

Consequently, when in the communication phase (as indicated by internal functions in the Radio Network layer), the frame transmission starts in downlink in the initial RFCI/RAB-Flow Combination.

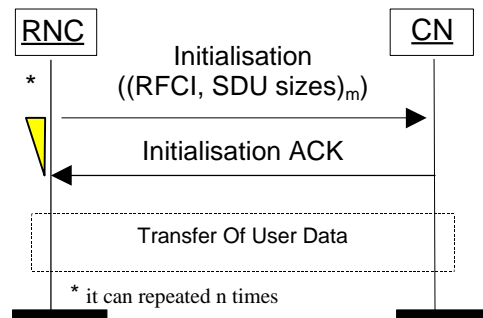

Figure x. Successful Initialisation of Iu UP for ~~m~~ RFCIs

Note of the editor: The need for an acknowledgement frame (and time supervision) and a repetition mechanism is FFS.

4.1.1.2 Unsuccessful operation

If the initialisation frame is uncorrectly formatted and cannot be correctly treated by the receiving Iu UP protocol layer, this latter sends an initialisation negative acknowledgment frame and remains in “Initialisation” state.

If after n repetition, the initialisation procedure is unsuccessfully terminated (because of n negative acknowledgment or timer expiries), the Iu UP protocol layers (sending and receiving) move to the “Abnormal Event State”.

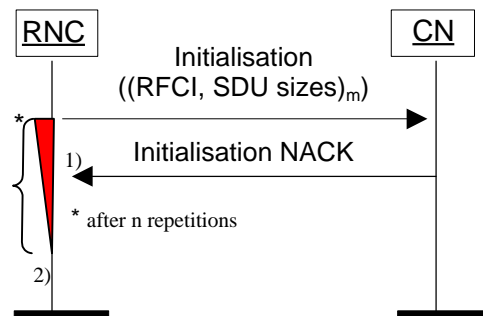

Figure x+1. Unsuccessful initialisation of Iu UP: 1) n negative acknowledgment or 2) n timer expiries

Note of the editor: The case where an SRNCs receives an Iu ~~control (FFS)~~ frame indicating that an initialisation procedure is active at the other end of the Iu UP could be related to a TFO or TrFO negotiation. How TFO or TrFO protocol and codec negotiation is performed is FFS.

4.1.4 Rate Control procedure

4.1.5 Time Alignment procedure (FFS)

4.1.6 Handling of Abnormal Event procedure

4.1.7 Frame Classification

4.61.3 Elements for Iu UP communication in Support mode

6.6.11.3.1 Frames Format for predefined size SDUs

6.6.1.11.3.1.1 PDU Type 0

The following shows the Iu frame structure for PDU type 0 of the Iu UP protocol at the SAP towards the transport layers (TNL-SAP):

Bits								Number of Octets	
7	6	5	4	3	2	1	0		
PDU Type				Frame Number				1	Frame Control Part
PCP	Spare	RFCI						1	
Procedure Control Bitmap								1-n	Frame Procedur e Control Part (Conditional)
Procedure Control Field (e.g. Initialization Control field)								1-n	
Frame Payload Check Sum				Frame Header Check Sum				1	Frame Check Sum Part
Payload Fields								0-n	Frame Payload part

Figure 4: Iu UP PDU Type 0 Format

C: Conditional

M: Mandatory

O: Optional

The Iu UP PDU Type 0 is made of four parts:

- 1) Iu UP Frame Control part (Mandatory)
- 2) Iu UP Frame Procedure Control part (Conditional)
- 3) Iu UP Frame Check Sum (Mandatory)
- 4) Iu UP Frame Payload part (Mandatory)

The Iu UP Frame Control Part, the Iu UP Frame Procedure Control Part and the Iu UP Frame Check Sum constitute the Iu UP Frame Header.

4.1.21.3.2 Frames Format for variable size SDUs

6.6.31.3.3 Frames content definition

6.6.4 Frame Number

The Iu UP frame numbering is handled by a Frame Number. The purpose of the Frame Number is to provide the receiving entity with a mechanism to keep track of lost Iu UP frames.

For a given user data connection, there is no relations between the frame numbers of frames sent in the downlink direction and the frame numbers of frames sent in the uplink direction.

The frame number is in bit 0 to bit 3 in the first octet of the frame the value varying from 0 to 15.

6.6.5 PDU Type

The PDU type indicates the structure of the Iu UP frame. The field takes the value of the PDU Type it identifies: i.e. 0 for PDU Type 0. The PDU type is in bit 4 to bit 7 in the first octet of the frame.

6.6.6 RAB sub-Flow Combination Indicator (RFCI)

The RFCI is stored in bit 0 to bit 5 of the second octet of the frame control part. The RFCI can get values ranging from 0 to 62. The value 63 is reserved for indicating that RFCI is not applicable for the current PDU.

6.6.7 PCP (Procedure Control Part Presence indicator)

The bit 7 of octet 2 indicates the presence of the Frame Procedure Control Part. If there is no Frame Procedure Control Bitmap present, the field has the value 0.

6.6.8 Procedure Control bitmap

When the Frame Procedure Control Part is present as indicated by the PCP bit, the Procedure Control Bitmap is mandatory, as well as at least one Control field.

The Procedure Control bitmap is a bitmap field indicating which procedure control fields follow in the Iu Frame Procedure Control Part. When a bit is set to 1 then the corresponding Procedure Control field will follow. The procedure control fields will sequentially appear in the Frame Control Procedure part of the Iu UP protocol frame. When there are several bits active in Procedure Map, then the Control fields follow the order given by the bits, starting from the least significant bit.

Bit	Definition
0	Initialization procedure
1	Rate Control
2	TBD (Time Alignment)
3	TBD (Abnormal Event)
4	Spare

5	Spare
6	Spare
7	Extension Bit

A bit value of 0 indicates that the corresponding Frame Procedure control is not active in the sending entity and that the associated Procedure Control Field is not present in the Frame Procedure Control part.

A bit value of 1 indicates that the corresponding Frame Procedure control is active in the sending entity and that the associated Procedure Control Field is present in the Frame Procedure Control part.

The Procedure Control Bitmap may be extended if more than 7 bits are needed in the future. If the Extension Bit is set to 1 then also the following octet will function as a Procedure Control Bitmap.

6.6.9 Procedure Control Fields

6.6.9.1 General

The Procedure Control Fields has information of the procedure as indicated by the Procedure Control Bitmap. The bit 7 of the Control Fields function as an extension bit, so that the Control Information for one procedure may consist of more than 7 bits.

6.6.9.2 Initialization Control Field

The Initialization procedure is described in section XX.

The coding of the Iu Initialization is TBD.

6.6.10 Iu UP Frame Header Check Sum

This field contains the check sum of all fields in Frame Header, except the Frame Check Sum part.

6.6.11 Iu UP Frame Payload Check Sum

This field contains the check sum of all fields in the Frame Payload.

6.6.12 Iu UP Payload part

The payload part contains the user data information coming from the upper layers as payload information.

6.6.13 1.3.4 Frames coding

6.6.14 1.3.5 Timers

6.7 1.4 Handling of unknown, unforeseen and erroneous protocol data

7 Communication Primitives for the Iu UP protocol layer

7.1 Modelling Principle

The principle illustrated by the figure below is used for modelling the primitives towards the protocol layer:

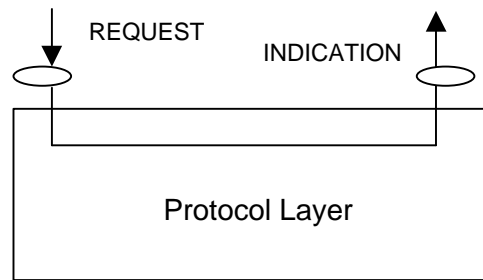

4.2 Primitives towards the upper layers at the RNL SAP

7.2.4 General

The Iu UP protocol layer interacts with upper layers as illustrated in *figure XX*. The interactions with the upper layers are shown in terms of primitives where the primitives represent the logical exchange of information and control between the upper layer and the Iu UP protocol layer. They do not specify or constraint implementations.

The following primitives are defined:

- Iu-UP-DATA
- Iu-UP-STATUS
- Iu-UP-UNIT-DATA

Table 1. Iu UP protocol layer service primitives towards the upper layer at the RNL SAP

Primitive	Type	Parameters	Comments
Iu-UP-DATA	Request	Iu-UP-payload	
		Iu-UP-control	RFCI RFC Request (Note 1) Abnormal Event
	Indication	Iu-UP-payload	
		Iu-UP-control	RFCI RFC Request (Note 2) Abnormal Event Time Alignment (FFS Note 3)
Iu-UP-Status	Indication	Iu-UP- Procedure -Control	Abnormal Event Initialisation RFC Request (Note 2) Abnormal Event Time Alignment (FFS Note 3)
	Request	Iu-UP- Procedure -Control	Abnormal Event RFC Request (Note 1)
Iu-UP-UNIT-DATA	Request	Iu-UP-payload	
	Indication	Iu-UP-payload	

Primitives usage is function of the mode of operation of the Iu UP protocol. The following table provides the association between Iu UP primitives towards the upper layers and the Iu UP mode of operation:

Table 2. Iu UP protocol layer service primitives related to the Iu UP mode of operation and function within the mode of operation:

Primitive	Type	Mode of Operation
Iu-UP-DATA	Request	SMpSDU
	Indication	SMpSDU
Iu-UP-Status	Request	SMpSDU
	Indication	SMpSDU
Iu-UP-UNIT-DATA	Request	TrM
	Indication	TrM

4.1.2 Iu-UP-DATA-REQUEST

This primitive is used as a request from the upper layer Iu NAS Data Stream entity to send a RAB SDU on the established transport connection. [This primitive also includes the RFCI of the payload information included in the primitive.](#)

~~When an abnormal condition like a corrupted is detected, then this primitive includes Control Information. This primitive may also include abnormal event control information related to frame(s) sent earlier by the Iu CS DS peer entity.~~

Note 1: This information is related to rate control.

The Iu UP Frame protocol layer forms the Iu UP data frame, the Iu Data Stream DU being the payload of the Iu UP frame, and transfers the frame by means of the lower layer services.

4.1.3 Iu-UP-DATA-INDICATION

This primitive is used as an indication to the upper layer entity to pass the Iu NAS Data Stream User Plane information of a received Iu UP frame.

This primitive ~~normally also~~ includes ~~also~~ the RFCI of the payload information included in the primitive. ~~If it does not include the RFCI, this shall be interpreted as if no RAB sub-flow combination change occurred since the last received RFCI.~~

This primitive may also include a request for a RFC change. This corresponds to the case where a change of RFC needs to be applied to the frames sent in the opposite direction.

Note 2: This information is related to rate control.

This primitive may also include ~~an abnormal event~~ information aiming at informing the upper layers of a faulty situation that ~~may~~ relates ~~to the payload included in the primitive~~ ~~or to frame(s) sent earlier by the Iu CS DS receiving entity.~~

Note 3: Time Alignment is FFS.

4.1.4 Iu-UP-STATUS-REQUEST

Note: The usage of this primitive is to be defined.

4.1.5 Iu-UP-STATUS-INDICATION

This primitive is used to report to the upper layer entity that a fault has been detected. The information concerning that fault is characterised by the Abnormal event information passed to the upper layer.

This primitive is also used in the context of the initialisation control procedure to pass to the upper Iu DS layer e.g. the RFC set and the associated RFCIs to be used in the communication phase.

~~**Note:** It is assumed here that no payload is transferred with the initialisation frame. Whether an acknowledgement frame is necessary is FFS.~~

4.1.6 Iu-UP-UNIT-DATA-REQUEST

This primitive is used as a request from the upper layer to send an Iu UP payloadPDU on the established transport connection ~~in the transparent mode of operation.~~

The Iu UP protocol layer transfers the Iu Data Stream DU by means of the lower layer services without adding any protocol header overhead.

4.1.7 Iu-UP-UNIT-DATA-INDICATION

This primitive is used as an indication to the upper layer entity to pass the Iu UP payloadPDU ~~of a received Iu UP frame~~ ~~in the transparent mode of operation.~~

4.3 Primitives towards the transport layers at TNL SAP

7.3.1 General

Access to the Transport network Layer is performed through a generic SAP: TNL-SAP.

When the Transport Network upper layer consists of AAL2, the TNL SAP maps onto the AAL-SAP through which communication is performed using specific AAL primitives.

When the Transport Network upper layer consists of GTP-U, the TNL SAP maps onto the GTP-U SAP through which communication is performed using generic primitives.

The choice of communication, specific or generic, through the TNL SAP~~Transport network layer SAP, currently AAL-SAP or GTP-U-SAP~~, is fixed by the Radio Network Layer control plane logic. This choice is based on the requirements placed by e.g. the RAB characteristics, the CN domain requesting the RAB establishment or other operator's choice.

7.3.2 Primitives at the TNL AAL-SAP with: ATM/AAL2 Transport layer

When the Iu UP protocol layer uses the services of an ATM/AAL2 transport, it uses an established AAL2 connection for transferring frames between the peer ~~CS~~ TNL-SAPs at both end of the Iu User plane access points. The Transport Network Control Plane over Iu handles the signalling to establish and release the AAL2 call connections.

7.3.3 AAL2 Service Primitives used by the Iu UP protocol

AAL2 services and primitives used at the Service Access Point from the AAL2 layer are shown in the following table:

Table 2. AAL2 primitives and parameters

Primitive	Type	Parameters	Comments
AAL-UNITDATA	Request	AAL-INFO	1-45 Octets of Iu UP protocol data
		AAL-UUI	Not used (Note 1)
AAL-UNITDATA	Indication	AAL-INFO	1-45 Octets of Iu UP protocol data
		AAL-UUI	Not used (Note 1)

Note 1 *The setting of this field is set or not used i.e. decimal value 26 according to [8]. must be defined. It is left FFS.*

The primitives of Table 2 are the standard primitives of [5]. These primitives are intended to be used in the Iu UP.

For the purpose of the Iu UP protocol, the AAL2 layer is limited to the Common Part Sublayer i.e. no Service Specific Convergence Sublayer is required.

Note of the editor: The SCS SAAR has not been proposed so far because it is not necessary for low bandwidth speech such as AMR. This proposal will be revisited when CS Data will be introduced in the Iu User Plane.

7.3.4 Primitives at the TNL GTP-U-SAP with: GTP-U Transport Layer

Note: The GTP-U-SAP has not been defined yet. The standardisation of this SAP and related primitives should be on the responsibility of TSG-N2. A LS asking for standardisation of GTP-U-SAP should be sent from R3 to N2.

When the Iu UP protocol layer uses the services of a GTP-U transport, it uses an established GTP-U tunnel for transferring frames between the peer GTP-U tunnel endpoints-SAPs at both end of the Iu User plane access points. The RANAP Control Plane signalling over Iu handles the signalling to establish and release the GTP-U tunnels.

Generic Service Primitives used by the lu UP protocol

Generic primitives are used at the GTP-U SAP. They are shown in the following table:

Table 3. Generic primitives and parameters to and from GTP-U layer

<u>Primitive</u>	<u>Type</u>	<u>Parameters</u>	<u>Comments</u>
<u>lu-UP-UNITDATA</u>	<u>Request</u>	<u>lu-UP-payload</u>	
<u>lu-UP-UNITDATA</u>	<u>Indication</u>	<u>lu-UP-payload</u>	

8 Annex A (Normative)

92 Annex AB (Informative): Illustration of usage of RFCI for AMR speech RAB.

This annex contains information related to usage of RFCIs in the context of AMR speech RAB.

The following figure illustrates the RFCI allocation and flow throughout the UTRAN.

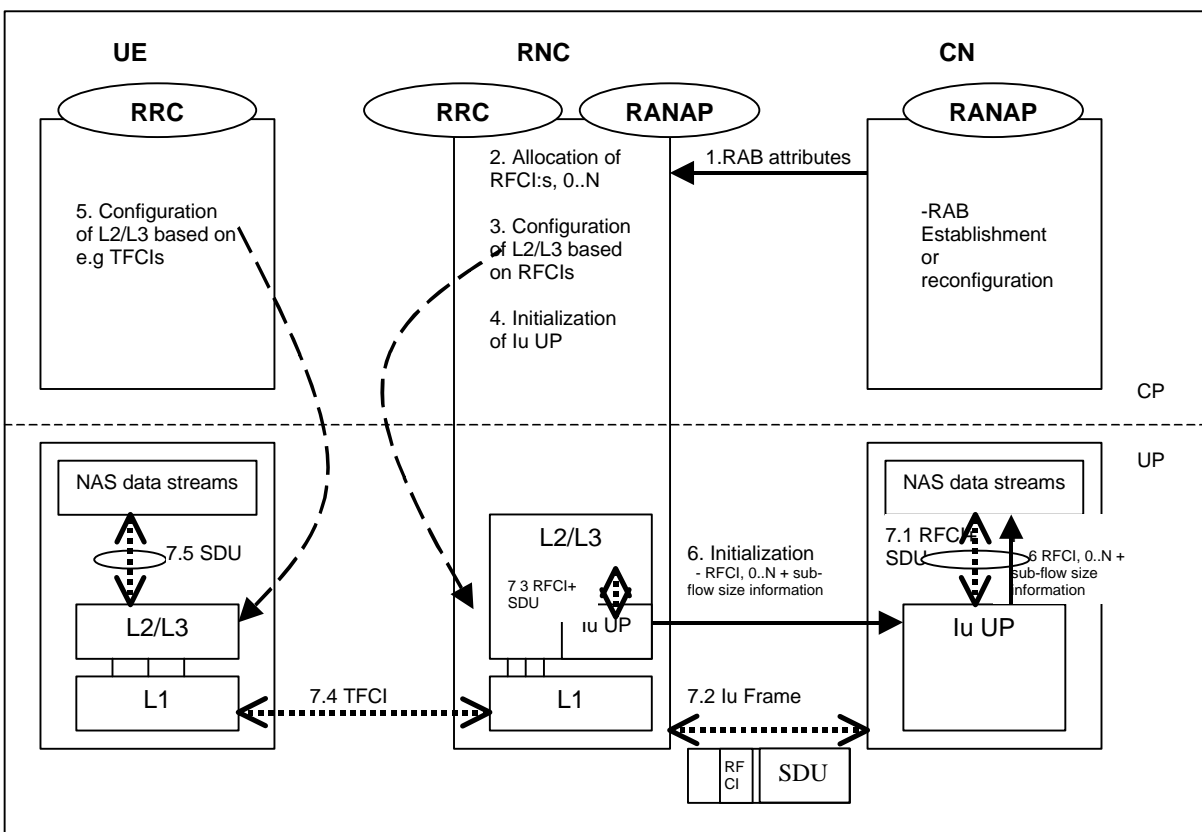

Note: The usage of RFCI in steps 4 and 8.5 is still to be agreed in RAN WG2.

1. **RAB Attributes:** at RAB establishment or reconfiguration, the SDU size information parameter is passed to UTRAN. The SDU information is organised per BER i.e. RAB sub Flow. For instance, 12.2 kbits/s AMR codec is passed as RAB sub flow 1 SDU size: 81 bits –class A bits-, RAB sub flow 2 SDU size: 1038 –class B bits-, as RAB sub flow 3 SDU size: 60 –class C-, which makes one RAB sub Flow Combination. This is done for all rates (i.e. all codec modes, DTX also if included). The lu UP is used in support mode for predefined SDU size.
2. **Allocation of RFCIs:** the RNC dynamically allocates an identification (RFCI) to each permitted/possible combinations it can offer. E.g. for 12.2. kbits/s, the RNC allocates RFCI 38 (according to the example table 24)
3. **Configuration of L2/3 based on RFCIs:** RFCIs are used to configure the L23. RLC is used transparently. MAC configures its coordinated DCHs with the RFCIs and associate one RFCI to one TFCI
- ~~4. RFCIs: RRC signalling is used to pass the association between the TFCI, the RFCIs and the SDU size information. RFCIs is used by the L23 to report to the Codec the received combination of SDUs over the radio transport channels~~
- ~~5.4. Initialization of lu UP: the RNC reports the permitted combinations it can offer to the transcoder using an inband lu initialisation frame containing the RFCIs and associated RAB sub Flow sizes.~~

6.5. Configuration of L2/3 based on e.g. TRFCIs: idem as 3. L23 will use e.g. TRFCI to communicate with the Codec about the RAB sub-Flow structure of the SDU received or to be sent.

7.6. RFCIs+ SDU size information: the RFCIs and associated RAB sub Flow sizes are received within the lu initialisation frame are passed to the Codec for configuration.

8.7. Example of DL frame transfer:

8.1.7.1. The Codec encodes a 12.2 kbits/s frame. It sends down to the lu UP and SDU with an associated RFCI equals to 38 (in this example)

8.2.7.2. The lu UP packs a frame with a header containing an RFCI set to value 38, and the payload made of the SDU received from the Codec.

8.3.7.3. The lu UP passes to L23, the lu frame payload (the Codec SDU) and the RFCI. The L23 uses this RFCI to break the lu frame onto the coordinated DCHs corresponding to the different bits protection classes. The corresponding TFCI is selected.

8.4.7.4. The radio frame is sent with the TFCI chosen by MAC

8.5.7.5. The L23 receives the SDUs on the coordinated DCHs, combined them back and uses e.g. the TFCI to indicate to the codec the structure of the received frame, set the RFCI to the correct value (i.e. 8 in this example). The RFCI and the L23 SDU is passed up to the codec, which decodes according to the RFCI the 12.2 kbits/s encoded speech frame.

The following table shows RAB sub-flow SDU sizes for a RAB with variable source rate as they are signalled in RAB assignment request in RANAP.

Table 1: Example of SDU sizes for AMR with DTX

RAB sub-flows			Total size of bits/RAB sub-flows combination	Source rate
RAB sub-Flow 1	RAB sub-Flow 2	RAB sub-Flow 3		
39	56	0	95	Source rate 1
49	54	0	103	Source rate 2
55	63	0	118	Source rate 3
55	79	0	134	Source rate 4
61	87	0	148	Source rate 5
75	84	0	159	Source rate 6
65	99	40	204	Source rate 7
81	103	60	244	Source rate 8
39	0	0	39	Source rate 9
⋮	⋮	⋮	⋮	⋮
0	0	0	0	Source rate M

NOTE 1: In the table above the grayed area shows what is signalled in RANAP RAB establishment request.

NOTE 2: In the table above the number of sub-flows is informative only.

SRNC allocates one or more possible/available RAB sub-flow combination(s) and generates RAB sub-flow combination set. RAB sub-flow combination number is dynamically generated by SRNC. This RAB sub-flow combination set is signalled towards CN with user plane signalling as described in [1]. The signalling towards UE is to be defined by TSG-RAN WG2.

RAB sub-flow combination set

A RAB sub-flow combination indicator, RFCI, indicates which RAB sub flow combination will be used for the Iu user frames. In the communication phase the RFCI is included in the user frame, and the RFCI state the structure of the user frame.

Table 2 below exemplifies the allocation of 4 different RAB sub-flows combinations for 3 sub-flows and generating of RAB sub-flows combination set.

Table 2: Example of Allocation of RAB sub-flows combination indicator

	RFCI (RAB sub-Flow Combination Indicator)	RAB sub- flow 1	RAB sub- flow 2	RAB sub- flow 3	Total	Source rate
RAB sub- flows combin ation set	0	0	0	0	0	Source rate 1
	1	39	0	0	39	Source rate 2
	2	39	56	0	95	Source rate 3
	3	81	103	60	244	Source rate 4

NOTE: In the table above the grayed area shows the part that is sent in the initialization procedure in Iu UP. This is what constitutes the RAB subflow combination set.

403 Annex BC (Informative) Document Stability Assessment Table

Section	Content missing	Incomplete	Restructuring needed	Checking needed	Editorial work required	Finalisation needed	Almost stable	Stable
1				√		√	√	
2				√		√	√	
3				√			√	
4			√	√	√	√	√	
5				√	√			√
6		√		√	√			
7		√		√		√		
8				√			√	

414 History

Document history

Edition x		Publication
0.0.1	Feb 1999	First draft
0.0.2	March 1999	Revised following RAN WG3#2 meeting: <ul style="list-style-type: none"> - TSG SA S2-99080: Iu UP instances - TSG RAN WG3#2 R3-99195
0.1.0	April 1999	Prepared for the RAN WG#3 meeting. <ul style="list-style-type: none"> - Document noted TSG SA S2-99080: Iu UP instances
0.1.1	May 1999	Revised following RAN WG3#3 meeting <ul style="list-style-type: none"> - Editorial additions: abbreviations, corrected references - TSG R3 (99) 281: incorporation of the proposals, inclusion of the frame format, RAB Format Selection and Time Alignment FFS - TSG R3 (99) 368: alignment of the 281 proposals with the co ordinated data streams concepts of 368. - Inclusion of detailed comments of the Iu SWG on TSG R3 (99) 281 - Note: <ul style="list-style-type: none"> - <i>TSG R3 (99) 257: provisions for load sharing on Iu between RNC and CN PS, moved to 25.414</i> - <i>TSG R3 (99) 276: incorporation of the two parts of proposal 1 (i.e. resulting in creation of appendix A): moved to 25.414</i>
0.1.2	May 1999	Revised by editor according to WG3#3 closing plenary meeting recommendations <ul style="list-style-type: none"> -Include Appendix A -Include Section 3.4.: Specification status
0.1.3	June 1999	Revised following RAN WG3#4 meeting. <ul style="list-style-type: none"> - Removal of the temporary appendix containing the GTP-U agreed proposal <i>TSG R3 (99) 276. Proposed in Liaison TSGR3#4 (99) 569</i> - Move the specification status atble to Annex B. Align layout with 25.401 editors proposal - Include TSGR3-99458, TSG R3-99459 - Add reference to AAL2 ITU specifications
0.1.4	June 1999	- Transparent/ Support mode
0.2.0	July 1999	- Approved version with comments proposed in R3-99593
0.2.1	July 1999	<ul style="list-style-type: none"> - Introduction of Mode concept: R3-99717 - R3-99718: Changes to 25.415 due to mode concept - R3-99719: Modelling of primitives for the Iu UP layer - R3-99724: Principles related to RAB sub flows - R3-99786, Summary of Iu SWG

0.2.2	August 1999	- Editor's proposal: R3-99339.
1.0.0.	August 1999	- Agreed editor's proposal: v0.2.2
1.0.1	August 1999	- Introduction of changes agreed from: R3-99979: Time alignment procedure without user data transmission R3-99936: Frame coding for PDU type 0 for Support Mode for predefined SDU size R3-99935: Downlink Rate Control over Iu
1.0.2	September 1999	- Editor's proposal: Text font harmonized at "Times New Roman 10" and few typos, heading level etc.. Clarification of Initialisation procedure Generic Transport Network Layer SAP created. GTP-U SAP is kpt (according to latest N2 decision) but uses generic primitives Transfer of User Data procedure described Primitive: Status passes procedure control information Primitive Data passes user data information and frame control information (RFCI, Frame Classification) Removal of RFCI on Uu SAR ca be used: determined based on maximum of SDU at Iu UP establishment UUI is set to decimal value 26 when not used by the AAL2 user. Removal of empty Annex A, replaced by Informative Annex B
Rapporteur for 3GPP RAN 25.415 is:		
<p>Alain G. Maupin Ericsson Radio Systems</p> <p>Tel. : +46 8 404 4379 Fax : +46 8 404 3597 Email : alain.maupin@era.ericsson.se</p>		
This document is written in Microsoft Word version 7. 0/97.		