

**TSG RAN Meeting #27**  
**Tokyo, Japan, 09 - 11 March 2005**

**RP-050056**

**Title** CRs (Rel-6 category B) for the introduction of fractional DPCH in RAN3 specifications  
**Source** TSG RAN WG3  
**Agenda Item** 9.2.1.1

RAN3 Tdoc	Spec	CR	Rev	Cat	curr. Vers.	new Vers.	Rel	Work item	Title
R3-050185	25.402	46		B	6.1.0	6.2.0	Rel-6	RANimp-RABSE-CodeOptFDD	Introduction of Fractional DPCH
R3-050186	25.420	47		B	6.2.0	6.3.0	Rel-6	RANimp-RABSE-CodeOptFDD	Introduction of Fractional DPCH
R3-050188	25.430	59		B	6.3.0	6.4.0	Rel-6	RANimp-RABSE-CodeOptFDD	Introduction of Fractional DPCH
R3-050276	25.423	1036	1	B	6.4.1	6.5.0	Rel-6	RANimp-RABSE-CodeOptFDD	Introduction of Fractional DPCH
R3-050277	25.433	1082	1	B	6.4.0	6.5.0	Rel-6	RANimp-RABSE-CodeOptFDD	Introduction of Fractional DPCH

## CHANGE REQUEST

# 25.402 CR 46 # rev - # Current version: 6.1.0 #

For **HELP** on using this form, see bottom of this page or look at the pop-up text over the # symbols.

**Proposed change affects:** UICC apps  ME  Radio Access Network  Core Network

<b>Title:</b>	# Introduction of Fractional DPCH		
<b>Source:</b>	# RAN3		
<b>Work item code:</b>	# RANimp-RABSE-CodeOptFDD	<b>Date:</b>	# 14/02/2005
<b>Category:</b>	# <b>B</b>	<b>Release:</b>	# Rel-6
	Use <u>one</u> of the following categories: <b>F</b> (correction) <b>A</b> (corresponds to a correction in an earlier release) <b>B</b> (addition of feature), <b>C</b> (functional modification of feature) <b>D</b> (editorial modification) Detailed explanations of the above categories can be found in 3GPP <a href="#">TR 21.900</a> .		Use <u>one</u> of the following releases: 2 (GSM Phase 2) R96 (Release 1996) R97 (Release 1997) R98 (Release 1998) R99 (Release 1999) Rel-4 (Release 4) Rel-5 (Release 5) Rel-6 (Release 6)

<b>Reason for change:</b>	# Introduction of the Fractional DPCH functionality.
<b>Summary of change:</b>	# Introduction of the Fractional DPCH functionality.
<b>Consequences if not approved:</b>	# Fractional DPCH will not be included in the specifications.

<b>Clauses affected:</b>	# 3.3, 5, 8.2.1, 9.1, 9.3.1, 9.3.1A						
<b>Other specs</b>	<table border="1" style="border-collapse: collapse; text-align: center;"> <tr> <td style="width: 20px;">Y</td> <td style="width: 20px;">N</td> </tr> <tr> <td style="height: 100px; vertical-align: top;">X</td> <td></td> </tr> </table>	Y	N	X		Other core specifications	# CR 194 on 25.211 v 6.3.0 CR 193 on 25.212 v 6.3.0 CR 70 on 25.213 v 6.1.0 CR 357 on 25.214 v 6.4.0 CR 148 on 25.215 v 6.1.0 CR 47 on 25.420 v 6.2.0 CR 1036 on 25.423 v 6.4.1 CR 59 on 25.430 v 6.3.0 CR 1082 on 25.433 v 6.4.0
Y	N						
X							
<b>affected:</b>	<table border="1" style="border-collapse: collapse; text-align: center;"> <tr> <td style="width: 20px;"></td> <td style="width: 20px;">X</td> </tr> <tr> <td style="height: 15px;"></td> <td style="height: 15px;">X</td> </tr> </table>		X		X	Test specifications O&M Specifications	
	X						
	X						
<b>Other comments:</b>	#						

**How to create CRs using this form:**

Comprehensive information and tips about how to create CRs can be found at <http://www.3gpp.org/specs/CR.htm>. Below is a brief summary:

- 1) Fill out the above form. The symbols above marked ⌘ contain pop-up help information about the field that they are closest to.
- 2) Obtain the latest version for the release of the specification to which the change is proposed. Use the MS Word "revision marks" feature (also known as "track changes") when making the changes. All 3GPP specifications can be downloaded from the 3GPP server under <ftp://ftp.3gpp.org/specs/> For the latest version, look for the directory name with the latest date e.g. 2001-03 contains the specifications resulting from the March 2001 TSG meetings.
- 3) With "track changes" disabled, paste the entire CR form (use CTRL-A to select it) into the specification just in front of the clause containing the first piece of changed text. Delete those parts of the specification which are not relevant to the change request.

### 3.3 Abbreviations

For the purposes of the present document, the following abbreviations apply:

ACK	(time alignment) acknowledgement
BFN	Node B Frame Number (counter)
CFN	Connection Frame Number (counter)
CH	Channel
CN	Core Network
CPICH	Common Pilot Channel
CRNC	Controlling RNC
DL	Down Link
DCH	Dedicated Channel
DOFF <sub>FDD</sub>	FDD Default DPCH Offset value
DOFF <sub>TDD</sub>	TDD Default DPCH Offset value
DPCH	Dedicated Physical Channel
DPCCH	Dedicated Physical Control Channel
DRNC	Drift RNC
DSCH	Downlink Shared Channel
FACH	Forward Access Channel
FDD	Frequency Division Duplex
<u>F-DPCH</u>	<u>Fractional DPCH</u>
GPS	Global Positioning System
HO	Handover
LTOA	Latest Time of Arrival
L1	Layer 1
L2	Layer 2
MAC	Medium Access Control
MBMS	Multimedia Broadcast Multicast Service
MCCH	MBMS point-to-multipoint Control Channel
MTCH	MBMS point-to-multipoint Traffic Channel
NACK	(time alignment) negative acknowledgement
PCCPCH	Primary Common Control Physical Channel
PCH	Paging Channel
PDU	Packet Data Unit
PTP	Point-to-Point
PTM	Point-to-Multipoint
PUSCH	Physical Uplink Shared Channel
RAB	Radio Access Bearer
RACH	Random Access Channel
RAN	Radio Access Network
RFN	RNC Frame Number (counter)
RL	Radio Link
RNC	Radio Network Controller
RNS	Radio Network Subsystem
RRC	Radio Resource Control
SAP	Service Access Point
SCH	Synchronisation Channel
SFN	Cell System Frame Number (counter)
SRNC	Serving RNC
SRNS	Serving RNS
TBS	Transport Block Set
TDD	Time Division Duplex
TOA	Time Of Arrival
TOAWE	Time Of Arrival Window Endpoint
TOAWS	Time Of Arrival Window Startpoint
TTI	Time Transmission Interval
UE	User Equipment
UL	Up Link
UMTS	Universal Mobile Telecommunications System
USCH	Uplink Shared CHannel

UTRAN      UMTS Terrestrial Radio Access Network

## 5 Synchronisation Counters and Parameters

This clause defines counters and parameters used in the different UTRAN synchronisation procedures.

The parameters used only by FDD has been indicated with the notation [FDD – parameter].

<b>BFN</b>	Node B Frame Number counter. This is the Node B common frame number counter. [FDD -BFN is optionally frequency-locked to a Network synchronisation reference]. Range: 0 .. 4095 frames.
<b>RFN</b>	RNC Frame Number counter. This is the RNC node common frame number counter. RFN is optionally frequency-locked to a Network synchronisation reference. Range: 0 .. 4095 frames.
<b>SFN</b>	Cell System Frame Number counter. SFN is sent on BCH. SFN is used for paging groups and system information scheduling etc. In FDD SFN = BFN adjusted with T <sub>cell</sub> . In TDD, if Inter Node B synchronisation port is used, SFN is locked to the BFN (i.e. SFN mod 256 = BFN mod 256). Range: 0 .. 4095 frames.
<b>CFN</b>	Connection Frame Number (counter). CFN is the frame counter used for the L2/transport channel synchronisation between UE and UTRAN. A CFN value is associated to each TBS and it is passed together with it through the MAC-L1 SAP. CFN provides a common frame reference (at L2) to be used e.g. for synchronised transport channel reconfiguration (see [2] and [3]).

The duration of the CFN cycle is longer than the maximum allowed transport delay between MAC and L1 (in UTRAN side, between SRNC and Node B, because the L1 functions that handle the transport channel synchronisation are in the Node B).  
Range: 0 .. 255 frames. When used for PCH the range is 0 .. 4095 frames.

<b>Frame Offset</b>	Frame Offset is a radio link specific L1 parameter used to map the CFN, used in the transport channel, into the SFN that defines the specific radio frame for the transmission on the air interface.
---------------------	--

At the L1/L2 interaction, the mapping is performed as:

$$- \text{SFN mod } 256 = (\text{CFN} + \text{Frame Offset}) \text{ mod } 256 \text{ (from L2 to L1)} \quad (5.1);$$

$$- \text{CFN} = (\text{SFN} - \text{Frame Offset}) \text{ mod } 256 \text{ (from L1 to L2)} \quad (5.2).$$

The resolution of all three parameters is 1 frame. Frame Offset and CFN have the same range (0...255) and only the 8 least significant bits of the SFN are used. The operations above are modulo 256.

In the UTRAN, the Frame Offset parameter is calculated by the SRNC and provided to the Node B.

<b>OFF</b>	The parameter OFF is calculated by the UE and reported to the UTRAN only when the UTRAN has requested the UE to send this parameter. In the neighbouring cell list, the UTRAN indicates for each cell if the Frame Offset is already known by the UTRAN or shall be measured and reported by the UE.
------------	--

OFF has a resolution of 1 frame and a range of 0 .. 255.

Five different cases are discerned related to the determination of the OFF value by the UE:

1. The UE changes from common channel state to dedicated channel state: 1 RL.  
In this case OFF is zero.
2. [FDD -The UE changes from common channel state to dedicated channel state: several RL's.  
OFF is in this case defined as being the difference between SFN of the candidate cells

and the SFN of the camping cell. Again the UE sets OFF to zero for the cell to which the UE sends an UL RRC message (cell #1). For cells #2 to n, the UE sets OFF to the difference between the SFN of cell#2,n and the SFN of cell#1.

This could be seen as if a virtual dedicated physical channel (DPCH) already is aligned with cell #1].

3. The UE adds another RL or moves to another cell in dedicated channel state.  
OFF is in this case defined as being the time difference between the CFN and the SFN of the cell in which the RL is to be added. In case this difference cannot be measured, a value as in [FDD - 13] [TDD - 14] shall be reported instead.
4. The UE is coming from another RAN and goes to dedicated channel state: 1 RL.  
This case is identical to case 1).
5. [FDD - The UE is coming from another RAN or another frequency in the same RAN and goes to dedicated channel state: several RL's.  
This case is identical to case 2), with one exception: OFF will not be zero for the cell to which the UE sends an UL RRC message (the measurement information will be received via the CN in this case) but for a reference cell selected by the UE. All other reported OFF values will be relative to the SFN of this selected reference cell].

#### [FDD – DOFF<sub>FDD</sub>]

The DOFF<sub>FDD</sub> (FDD Default DPCH Offset value) is used to define Frame Offset and Chip Offset at first RL setup. [The DOFF<sub>FDD</sub> is used for both the DPCH and the F-DPCH.](#) The resolution should be good enough to spread out load over Iub and load in Node B (based on certain load distributing algorithms). In addition it is used to spread out the location of Pilot Symbol in order to reduce the peak DL power since Pilot symbol is always transmitting at the fixed location within a slot (the largest number of chips for one symbol is 512 chips).

The SRNC sends a DOFF<sub>FDD</sub> parameter to the UE when the new RL will make the UE change its state (from Cell\_FACH state or other when coming from another RAN) to Cell\_DCH state.

Resolution: 512 chips; Range:0 .. 599 (< 80 ms).

#### [TDD – DOFF<sub>TDD</sub>]

The DOFF<sub>TDD</sub> (TDD Default DPCH Offset value) is used to define Frame Offset at first RL setup, in order to spread out load over Iur and load in Node B (based on certain load distributing algorithms).

The SRNC sends a DOFF<sub>TDD</sub> parameter to the UE when the new RL will make the UE change its state (from Cell\_FACH state or other when coming from another RAN) to the Cell\_DCH state.

Resolution: 1 frame; Range: 0 .. 7 frames.

#### [FDD – Chip Offset]

The Chip Offset is used as offset for the DL DPCH [or the F-DPCH](#) relative to the PCCPCH timing. The Chip Offset parameter has a resolution of 1 chip and a range of 0 .. 38399 (< 10 ms).

The Chip Offset parameter is calculated by the SRNC and provided to the Node B.

Frame Offset + Chip Offset (sent via NBAP) are in Node B rounded together to closest 256 chip boundary. The 256 chip boundary is used regardless of the used spreading factor, also when the spreading factor is 512. The rounded value (which is calculated in Node B) controls the DL DPCH air-interface timing [or the F-DPCH air-interface timing.](#)

The "Frame Offset + Chip Offset" 256 chip boundary rounding rules for Node B to consider for each DL DPCH [and each F-DPCH](#) are:

1. IF (Frame Offset x 38 400 + Chip Offset) modulo 256 [chips] = {1..127} THEN round (Frame Offset x 38 400 + Chip Offset) modulo 256 frames down to closest 256 chip boundary.
2. IF (Frame Offset x 38 400 + Chip Offset) modulo 256 [chips] = {128..255} THEN round (Frame Offset x 38 400 + Chip Offset) modulo 256 frames up to closest 256 chip boundary.

3. IF (Frame Offset x 38 400 + Chip Offset) modulo 256 [chips] = 0 THEN "Frame Offset x 38 400 + Chip Offset" is already on a 256 chip boundary.

#### [FDD – DPCH Frame Offset]

The DPCH Frame Offset is used as offset for the DL DPCH [or the F-DPCH](#) relative to the PCCPCH timing at both the Node B and the UE. The DPCH Frame Offset parameter has a resolution of 256 chips and a range of 0 .. 38144 chips (< 10 ms).

The DPCH Frame Offset is equivalent to Chip Offset rounded to the closest 256 chip boundary. It is calculated by the SRNC and sent to the UE by the SRNC for each radio link in the active set.

The DPCH Frame Offset controls the DL DPCH air-interface timing [or the F-DPCH air-interface timing](#). It enables the DL DPCHs [or the F-DPCH](#) for radio links in the Active Set to be received at the UE at approximately the same time, which can then be soft combined during soft handover.

#### [FDD – T<sub>m</sub>]

The reported T<sub>m</sub> parameter has a resolution of 1 chip and a range of 0 .. 38399. The T<sub>m</sub> shall always be sent by the UE.

Five different cases are discerned related to the determination of the T<sub>m</sub> value by the UE:

1. The UE changes from common channel state to dedicated channel state: 1 RL.  
In this case the T<sub>m</sub> will be zero.
2. The UE changes from common channel state to dedicated channel state: several RL's.  
T<sub>m</sub> is in this case defined as being the time difference between the received PCCPCH path of the source cell and the received PCCPCH paths of the other target cells. Again the UE sets T<sub>m</sub> to zero for the cell to which the UE sends an UL RRC message (cell #1). For cells #2 to n, the UE sets T<sub>m</sub> to the time difference of the PCCPCH reception timing of cell#2,n from the PCCPCH reception timing of cell#1.
3. The UE adds another RL in dedicated channel state (macro-diversity).  
T<sub>m</sub> is in this case defined as being the time difference between "T<sub>UETX</sub> – T<sub>o</sub>" and the earliest received PCCPCH path of the target cell. T<sub>UETX</sub> is the time when the UE transmits an uplink DPCCCH frame, hence "T<sub>UETX</sub> – T<sub>o</sub>" is the nominal arrival time for the first path of a received DPCH.
4. The UE is coming from another RAN and goes to dedicated channel state: 1 RL.  
This case is identical to case 1.
5. The UE is coming from another RAN or another frequency in the same RAN and goes to dedicated channel state: several RL's.  
This case is identical to case 2, with one exception: T<sub>m</sub> will not be zero for the cell to which the UE sends an UL RRC message (the measurement information will be received via the CN in this case) but for a reference cell selected by the UE. All other reported T<sub>m</sub> values will be relative to the timing of the PCCPCH in this cell.

#### [FDD – T<sub>cell</sub>]

T<sub>cell</sub> represents the Timing delay used for defining the start of SCH, CPICH and the DL Scrambling Code(s) in a cell relative BFN. The main purpose is to avoid having overlapping SCHs in different cells belonging to the same Node B. A SCH burst is 256 chips long. SFN in a cell is delayed T<sub>cell</sub> relative BFN.

Resolution: 256 chips. Range: 0 .. 9 x 256 chips.

#### T1

RNC specific frame number (RFN) that indicates the time when RNC sends the DL NODE SYNCHRONISATION control frame through the SAP to the transport layer.

Resolution: 0.125 ms; Range: 0 .. 40959.875 ms.

#### T2

Node B specific frame number (BFN) that indicates the time when Node B receives the correspondent DL NODE SYNCHRONISATION control frame through the SAP from the transport layer.



Resolution: 0.125 ms; Range: 0 .. 40959.875 ms.

- T3** Node B specific frame number (BFN) that indicates the time when Node B sends the UL NODE SYNCHRONISATION control frame through the SAP to the transport layer.
- Resolution: 0.125 ms; Range: 0 .. 40959.875 ms.
- T4** RNC specific frame number (RFN) that indicates the time when RNC receives the UL NODE SYNCHRONISATION control frame. Used in RNC locally. Not standardised over Iub.
- TOAWS** TOAWS (Time of Arrival Window Startpoint) is the window startpoint. DL DATA FRAMES are expected to be received after this window startpoint. TOAWS is defined with a positive value relative Time of Arrival Window Endpoint (TOAWE) (see Figure 10). A data frame arriving before TOAWS gives a TIMING ADJUSTMENT control frame response.  
The resolution is 1 ms, the range is: {0 .. CFN length/2 –1 ms}.
- TOAWE** TOAWE (Time of Arrival Window Endpoint) is the window endpoint. DL DATA FRAMES are expected to be received before this window endpoint (see Figure 10). TOAWE is defined with a positive value relative Latest Time of Arrival (LTOA). A data frame arriving after TOAWE gives a TIMING ADJUSTMENT control frame response.  
The resolution is 1 ms, the range is: {0 .. CFN length –1 ms}.
- LTOA** LTOA (Latest Time of Arrival) is the latest time instant a Node B can receive a data frame and still be able to process it. Data frames received after LTOA can not be processed (discarded). LTOA is defined internally in Node B to be a processing time before the data frame is sent in air-interface. The processing time (Tproc) could be vendor and service dependent.  
LTOA is the reference for TOAWE (see Figure 14).
- TOA** TOA (Time of Arrival) is the time difference between the TOAWE and when a data frame is received. A positive TOA means that data frames are received before TOAWE, a negative TOA means that data frames are received after TOAWE. Data frames that are received after TOAWE but before LTOA are processed by Node B.  
TOA has a resolution of 125  $\mu$ s. TOA is positive when data frames are received before TOAWE (see Figure 12).  
The range is: {0 .. +CFN length/2 –125  $\mu$ s}.  
TOA is negative when data frames are received after TOAWE.  
The range is: {–125  $\mu$ s .. –CFN length/2}.

## 8.2 FDD Radio Interface Synchronisation

### 8.2.1 General

This section is fully applicable to both the DL DPCH and the F-DPCH. As such, wherever "DL DPCH" appears in this section (in text, figure and equations), it has to be replaced with "F-DPCH" in the context of "F-DPCH".

FDD Radio Interface Synchronisation assures that UE gets the correct frames when received from several cells. The UE measures the Timing difference between its DPCH and SFN in the target cell when doing handover and reports it to SRNC. SRNC sends this Time difference value in two parameters Frame Offset and Chip Offset over Iub to Node B. Node B rounds this value to the closest 256 chip boundary in order to get DL orthogonality (regardless of used spreading factor). The rounded value is used in Node B for the DL DPCH or the F-DPCH.

$DOFF_{FDD}$  is selected by the SRNC considering the interleaving period (e.g. 10, 20, 40 or 80 ms) when entering in dedicated state from common channel state.

Services are scheduled by using  $DOFF_{FDD}$  in order to average out the Iub traffic load and the Node B processing load.  $DOFF_{FDD}$  (FDD Default DPCH Offset value) is only used when setting up the first RL in order to initialise Frame Offset and Chip Offset and to tell UE when frames are expected.

UE uses the UL DPCH as it is a more defined time instant compared with DL DPCH.

The handover reference is the time instant  $T_{UE_{Tx}} - T_o$ , which is called  $DL\ DPCH_{nom}$  in the timing diagram.

$T_{cell}$  is used to skew cells in the same Node B in order to not get colliding SCH bursts, one SCH burst is 1/10 of a slot time.

The timing diagram in Figure 15 shows an example with two cells connected to one UE where handover is done from source cell (Cell 1) to target cell (Cell 2).

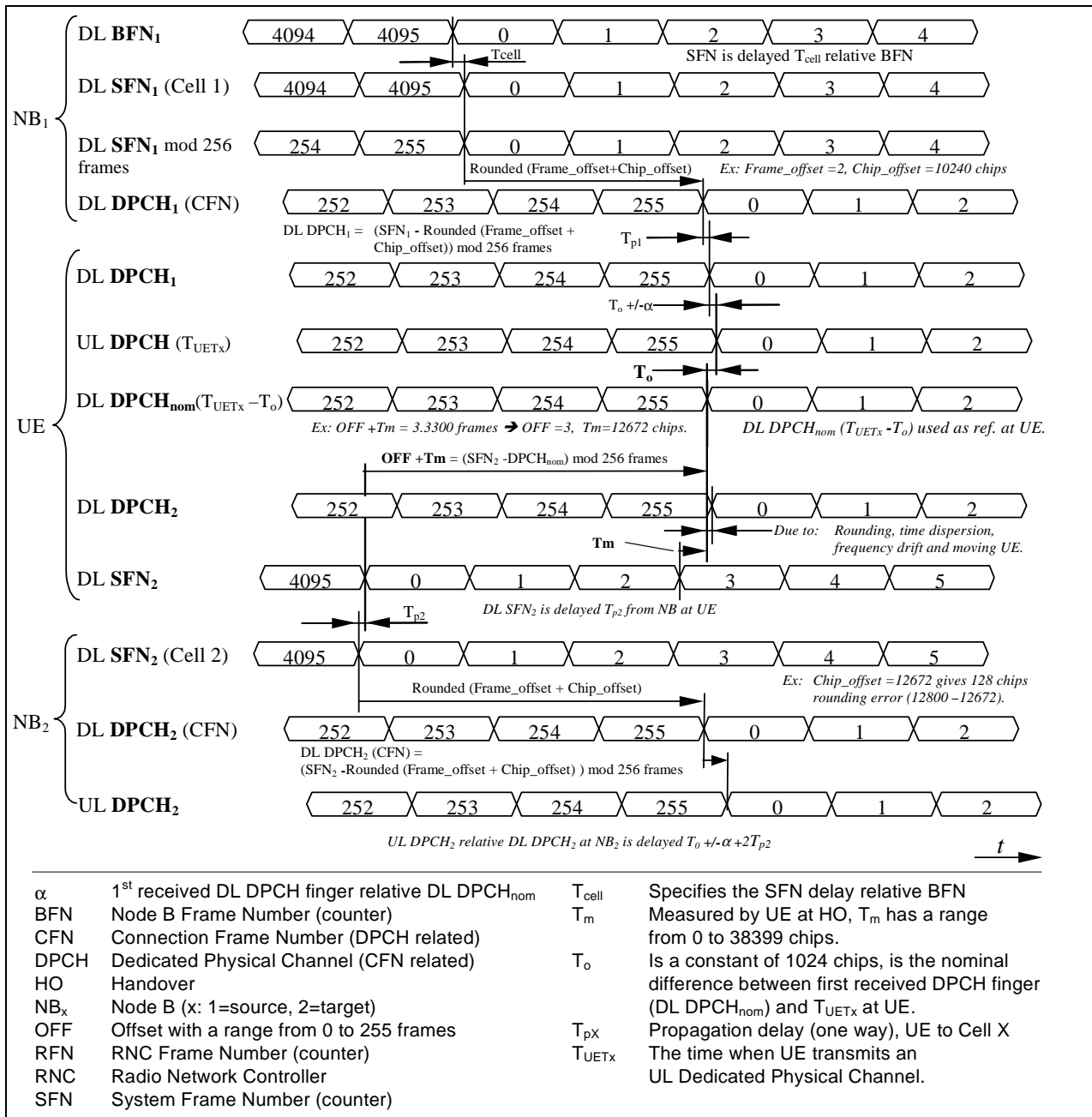

**Figure 15: FDD Radio Interface Synchronisation timing diagram**

SFN<sub>1</sub> is found in Cell 1 at Node B<sub>1</sub> and SFN<sub>2</sub> at Cell 2 and Node B<sub>2</sub>. SFN<sub>1</sub> is sent T<sub>cell1</sub> after the Node B<sub>1</sub> reference BFN<sub>1</sub>. CFN is the frame numbering that is related to each DL and UL Dedicated Physical Channel (DPCH). UL DPCH is sent from UE to both Cells (both Node B's in this example). UL DPCH<sub>2</sub> at Node B<sub>2</sub> is shown to indicate the difference to the DL DPCH<sub>2</sub> at Node B<sub>2</sub>.

The new RL (DL DPCH<sub>2</sub>) which is setup at the HO will face some deviation from nominal position due to the rounding of Frame Offset and Chip Offset to 256 chip boundary in Node B. Time dispersion and UE movements are examples of other factors affecting this phase deviation.

The nominal DL DPCH timing at UE is T<sub>o</sub> before the T<sub>UETX</sub> time instant, which could be expressed:

$$DL\ DPCH_{nom} = T_{UETX} - T_o \tag{8.1}$$

In UE dedicated state, OFF and T<sub>m</sub> are measured at UE according to the following equation:

$$OFF + T_m = (SFN_{target} - DL\ DPCH_{nom}) \bmod 256\ frames\ [chips] \tag{8.2}$$

NOTE: OFF has the unit Frames and T<sub>m</sub> the unit Chips.

EXAMPLE 1: Assume that  $OFF + T_m$  equals "3.3300" frames (as given as an example in Figure 15). Then  $OFF = 3$  and  $T_m = "0.33"$  which corresponds to  $T_m = 12672$  chips.

In other words (referring to the timing diagram in Figure 15):

- How to determine  $T_m$  at UE: Select a time instant 1) where frame N starts at DL SFN<sub>2</sub> e.g. frame number 3, the time from that time instant to the next frame border of DL DPCH<sub>nom 2</sub>) equals  $T_m$  (if these are in phase with each other,  $T_m$  is zero).
- How to determine OFF: The difference between the frame number selected for time instant 1) and the frame number starting at instant 2) mod 256 frames equals OFF.

EXAMPLE 2:  $(3 - 0) \bmod 256 = 3$ , another example is  $(1 - 254) \bmod 256 = 3$ .

# 9 Usage of Synchronisation Counters and Parameters to support Transport Channel and Radio Interface Synchronisation

## 9.1 General

This subclause describes how the different synchronisation parameters and counters are computed and used in order to obtain Transport Channel (L2) and Radio Interface (L1) Synchronisation.

The parameters that need to be determined by the UE are CFN, OFF [FDD – and Tm].

The parameter that need to be determined by the UTRAN are [FDD – DOFF<sub>FDD</sub>], [TDD – DOFF<sub>TDD</sub>], Frame Offset and [FDD – Chip Offset].

Figure 17 summarises how these parameters are computed. A detailed description of the actions in each state is given in the sections 9.2 – 9.4, while some examples of corrections applied to synchronisation counters during UE state transitions are shown in section 9.5.

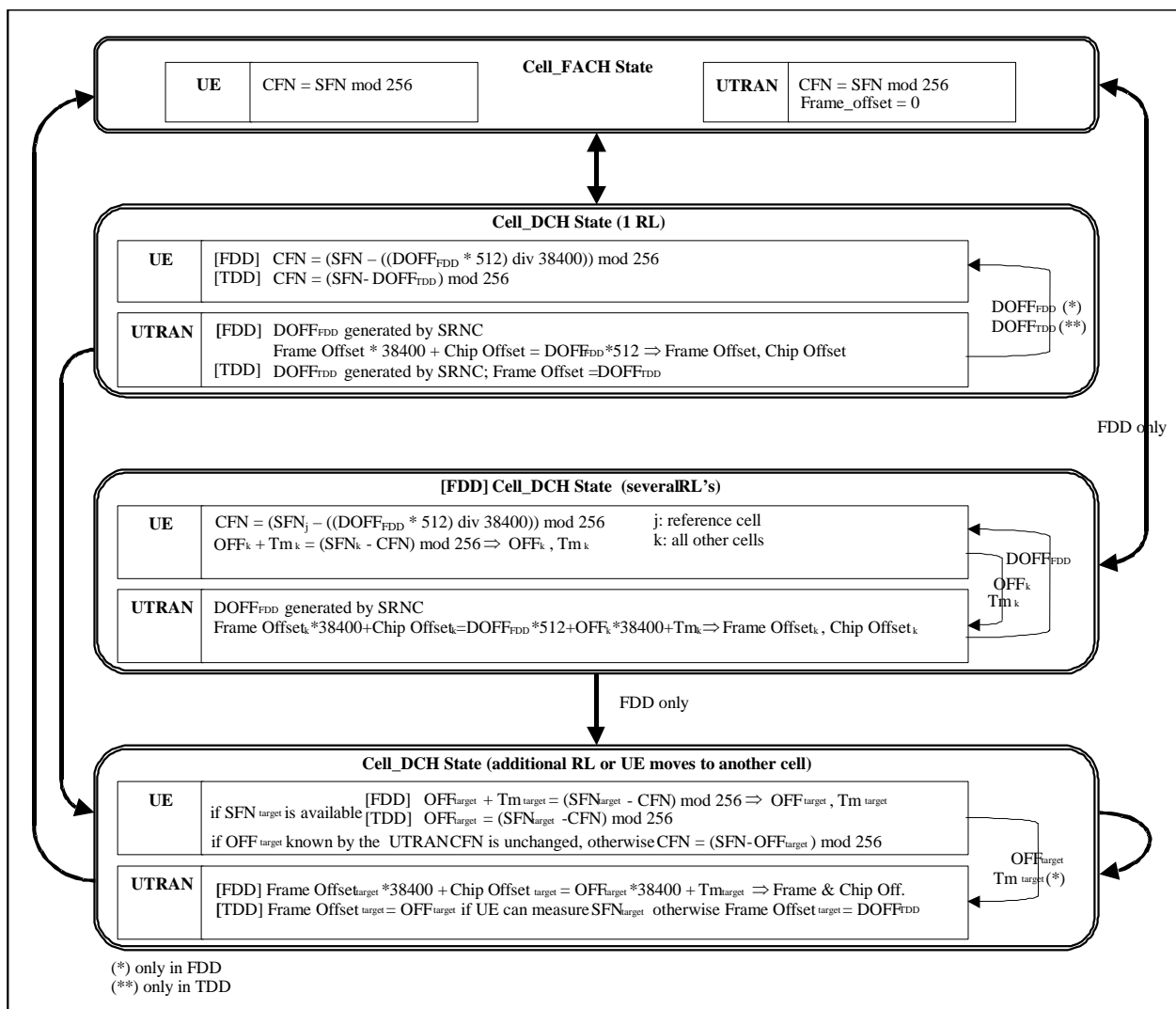
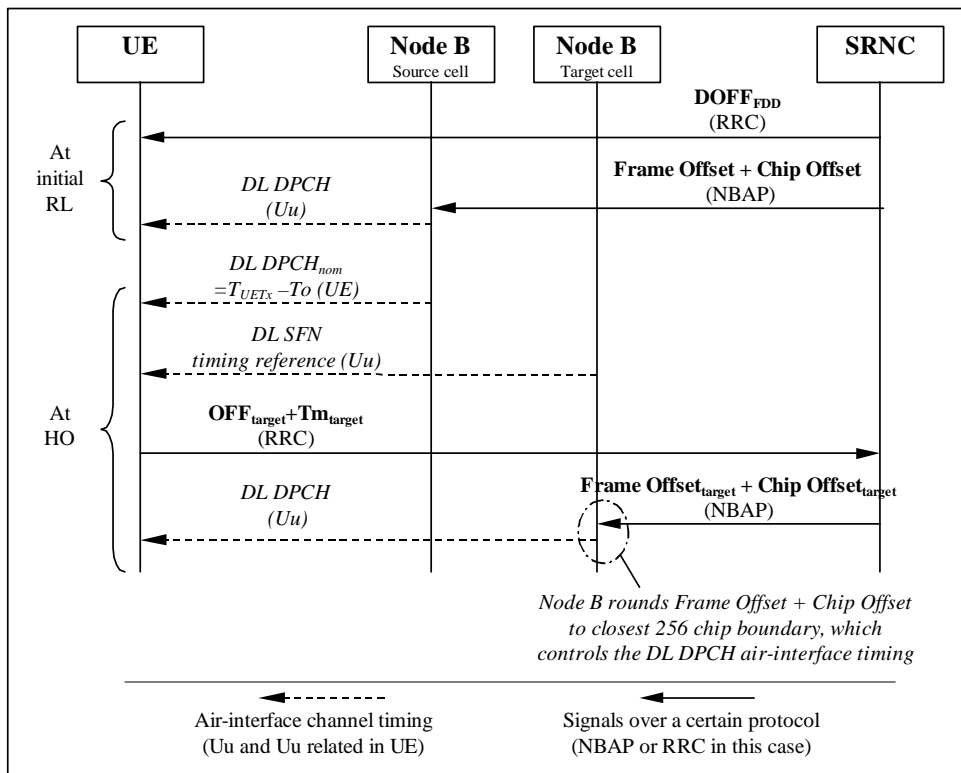

Figure 17: Calculations performed by UE and UTRAN

Figure 18 describes what offset parameters are signalled and used in the different nodes at Initial RL setup and at Handover (HO) in FDD. The rounding to closest 256 chip boundary is done in Node B. The rounded Frame Offset and Chip Offset control the DL DPCH air-interface timing [or the F-DPCH air-interface timing](#). The 256 chip boundary is to

maintain DL orthogonality in the cell (the rounding to the closest 256 chip boundary is done in Node B to facilitate the initial UL chip synchronisation process in Node B). As this figure is also applicable to F-DPCH, "DL DPCH" has to be replaced by "F-DPCH" everywhere in the figure in the context of F-DPCH.



**Figure18: [FDD - Usage of Offset values at initial RL and at HO]**

Figure 19 describes what offset parameters are signalled and used in the different nodes at Initial RL setup and at Handover (HO) in TDD.

Note that in some cases the parameter OFF<sub>target</sub> cannot be measured by the UE before handover (e.g. in case of inter frequency handover or inter-mode handover). In these cases a value as defined in [FDD - 13] [TDD - 14] shall be reported by the UE.

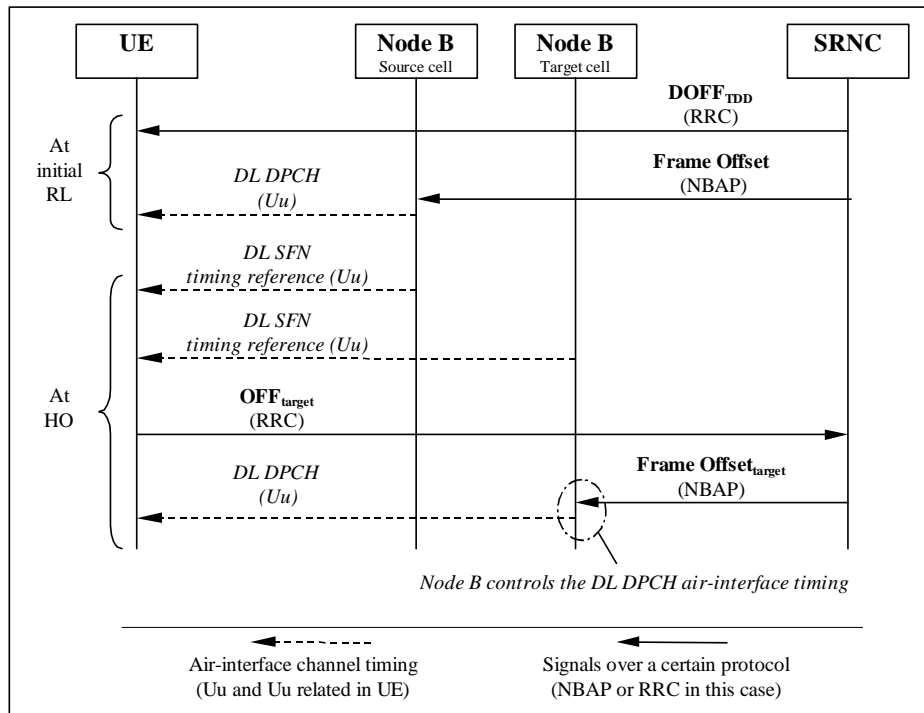

Figure 19: [TDD- Usage of Offset values at initial RL and at HO]

## 9.2 Calculations performed in the UTRAN

### 9.2.1 UE in CELL\_FACH/PCH state

In CELL\_FACH/PCH state the Frame Offset is set to 0 (for all common and shared channels).

### 9.2.2 UE changes from CELL\_FACH/PCH state to CELL\_DCH state: 1 RL

[FDD - Based on the received parameters from the UE and the  $DOFF_{FDD}$  value generated in the SRNC, the SRNC calculates the Frame Offset and the Chip Offset from formula (9.1):

$$\text{Frame Offset} * 38400 + \text{Chip Offset} = DOFF_{FDD} * 512 \tag{9.1}$$

Frame Offset and Chip Offset are then signalled to the Node B controlling the serving cell.]

[TDD - Based on the  $DOFF_{TDD}$  value generated in the SRNC, the SRNC calculates the Frame Offset =  $DOFF_{TDD}$ .

Frame Offset is then signalled to the Node B controlling the serving cell.]

[TDD - Note that for all common and shared channels Frame Offset is set to 0 even during CELL\_DCH state.]

### 9.2.3 [FDD - UE changes from CELL\_FACH/PCH state to CELL\_DCH state: several RL's]

Based on the received parameters from the UE for each cell<sub>k</sub> ( $OFF_k$  and  $Tm_k$ ) and the  $DOFF_{FDD}$  value generated in the SRNC, the SRNC calculates the  $Frame\ Offset_k$  and the  $Chip\ Offset_k$ . The  $Frame\ Offset_k$  and the  $Chip\ Offset_k$  are calculated from formula (9.2):

$$\text{Frame Offset}_k * 38400 + \text{Chip Offset}_k = DOFF_{FDD} * 512 + OFF_k * 38400 + Tm_k \tag{9.2}$$

NOTE: Formula (9.2) is covering formula (9.1) since in the case described in section 9.2.2,  $OFF_k$  and  $Tm_k$  are both equal to zero.

Each  $Frame\ Offset_k$  and  $Chip\ Offset_k$  are then signalled to the Node B controlling the cell<sub>k</sub>.

## 9.2.4 UE in CELL\_DCH state: addition of a new RL or handover to a new cell

[FDD - Based on the received parameters from the UE or already known by the UTRAN ( $OFF_{target}$ ,  $Tm_{target}$ ), the SRNC calculates the  $Frame\ Offset_{target}$  and the  $Chip\ Offset_{target}$  with formula (9.3):

$$Frame\ Offset_{target} * 38400 + Chip\ Offset_{target} = OFF_{target} * 38400 + Tm_{target} \quad (9.3)$$

During hard handover in case the parameter  $OFF_{target}$  cannot be measured by the UE and it is not already known by the UTRAN, than the SRNC calculates the  $Frame\ Offset_{target}$  and the  $Chip\ Offset_{target}$  with formula (9.1).

$Frame\ Offset_{target}$  and  $Chip\ Offset_{target}$  are then signalled to the Node B controlling the target cell.]

[TDD - Based on the parameter  $OFF_{target}$  received from the UE or already known by the UTRAN, the SRNC calculates the  $Frame\ Offset_{target} = OFF_{target}$ .

In case the parameter  $OFF_{target}$  cannot be measured by the UE and it is not already known by the UTRAN, than the SRNC calculates the  $Frame\ Offset_{target} = DOFF_{TDD}$ .

It is signalled to the Node B controlling the target cell.]

## 9.2.5 Handover from other RAN to UMTS

[FDD - Based on the definitions for  $OFF$  and  $Tm$  formula (9.1) can also be used when the UE enters the UTRAN from another CN and establishes one dedicated RL. The same is true for formula (9.2) when establishing one or more dedicated RL's.]

[TDD - When the UE enters the UTRAN from another CN and establishes one dedicated RL,  $OFF$  is 0.]

## 9.3 Calculations performed in the UE

### 9.3.A UE in CELL\_FACH/PCH state

In CELL\_FACH/PCH state the CFN is initialised with the values  $CFN = SFN$  for PCH and  $CFN = SFN \bmod 256$  for all other common and shared channels. The CFN for all common and shared channels in the CRNC is increased (mod 256) by 1 every frame, except PCH, which CFN has the same range of the SFN.

### 9.3.1 UE changes from CELL\_FACH/PCH state to CELL\_DCH state: 1 RL

[FDD - Based on the received  $DOFF_{FDD}$  and the SFN of the cell in which the UE is source, the UE can initialise the CFN with the value given by formula (9.4):

$$CFN = (SFN - ((DOFF_{FDD} * 512) \text{ div } 38400)) \bmod 256 \quad (9.4)$$

This formula gives the CFN of the downlink DPCH frame [or of the F-DPCH frame](#) which starts at the same time as or which starts during the PCCPCH frame with the given SFN.]

[TDD - Based on the received  $DOFF_{TDD}$ , the UE can initialise the CFN with the value given by formula (9.5):

$$CFN = (SFN - DOFF_{TDD}) \bmod 256 \quad (9.5)$$

After the initialisation, the CFN in the UE is increased (mod 256) by 1 every frame.

[TDD - Note that for all common and shared channels  $CFN = SFN \bmod 256$  even during CELL\_DCH state.]

### 9.3.1A [FDD - UE changes from CELL\_FACH/PCH to CELL\_DCH state: several RL's]

The UE reports to the SRNC the parameters  $OFF_k$  and  $Tm_k$  for each cell<sub>k</sub> measured respect to the reference cell, determined by means of formula (9.6):



$$\text{OFF}_k + \text{Tm}_k = (\text{SFN}_k - \text{CFN}) \bmod 256 \quad (9.6)$$

After having performed  $\text{OFF}_k$  and  $\text{Tm}_k$  measurements for all target cells, the UE initialises the CFN with the value given by formula (9.7), based on the received  $\text{DOFF}_{\text{FDD}}$  and the  $\text{SFN}_j$  of the reference cell:

$$\text{CFN} = (\text{SFN}_j - ((\text{DOFF}_{\text{FDD}} * 512) \text{ div } 38400)) \bmod 256 \quad (9.7)$$

This formula gives the CFN of the downlink DPCH frame [or of the F-DPCH frame](#) which starts at the same time as or which starts during the PCCPCH frame with the given SFN.

After the initialisation, the CFN in the UE is increased (mod 256) by 1 every frame.

### 9.3.2 UE in CELL\_DCH state: addition of a new RL or handover to a new cell

The UE in CELL\_DCH state may be requested by the UTRAN to report  $\text{OFF}_{\text{target}}$  by means of System Info broadcast in the source cell.

[FDD - In case the  $\text{SFN}_{\text{target}}$  can be measured, the target cell  $\text{OFF}_{\text{target}}$  is calculated using formula (9.8):

$$\text{OFF}_{\text{target}} + \text{Tm}_{\text{target}} = (\text{SFN}_{\text{target}} - \text{CFN}) \bmod 256 \quad (9.8)$$

otherwise a value as defined in [13] is reported.  $\text{Tm}_{\text{target}}$  is always reported, except for the case of FDD-TDD handover.]

[TDD - In case the  $\text{SFN}_{\text{target}}$  can be measured, the target cell  $\text{OFF}_{\text{target}}$  is calculated using formula (9.9):

$$\text{OFF}_{\text{target}} = (\text{SFN}_{\text{target}} - \text{CFN}) \bmod 256 \quad (9.9)$$

otherwise a value as defined in [14] is reported.]

Note that, regarding the CFN, two cases may occur:

- a) the value of  $\text{OFF}_{\text{target}}$  is known by the UTRAN before handover execution:
  - a1) either because the  $\text{SFN}_{\text{target}}$  has been measured by the UE and reported to the UTRAN by means of the  $\text{OFF}_{\text{target}}$  before handover;
  - a2) or because the UTRAN already knows the difference between serving cell  $\text{SFN}_{\text{source}}$  and target cell  $\text{SFN}_{\text{target}}$  and derives  $\text{OFF}_{\text{target}}$  from  $\text{OFF}_{\text{source}}$  by applying the difference between  $\text{SFN}_{\text{target}}$  and  $\text{SFN}_{\text{source}}$  (this difference between SFNs may be known in the UTRAN from previous UE's measurement reports);
  - a3) [TDD - or because cells involved in the handover are synchronised – and hence  $\text{OFF}_{\text{target}}$  equals  $\text{OFF}_{\text{source}}$  ].
- b) the value of  $\text{OFF}_{\text{target}}$  is not known by the UTRAN before handover execution because the  $\text{SFN}_{\text{target}}$  cannot be measured by the UE before handover and the UTRAN does not know the difference between serving cell SFN and target cell SFN.

In case a) the UTRAN shall not signal to the UE any value of [FDD-  $\text{DOFF}_{\text{FDD}}$ ] [TDD-  $\text{DOFF}_{\text{TDD}}$ ] before handover in the RRC message PHYSICAL CHANNEL RECONFIGURATION, and the UE shall maintain the old CFN, i.e. no correction to CFN is needed during handover.

In case b) the UTRAN shall signal to the UE the new value of [FDD-  $\text{DOFF}_{\text{FDD}}$ ] [TDD-  $\text{DOFF}_{\text{TDD}}$ ] before handover by means of the RRC message PHYSICAL CHANNEL RECONFIGURATION. The CFN shall be re-initialised after handover (as soon as the UE reads the  $\text{SFN}_{\text{target}}$ ) according to formula [FDD- (9.4)] [TDD- (9.5)].

Note that in cases a2) and a3) the UTRAN may not request the UE to report  $\text{OFF}_{\text{target}}$ , while in case b) the value of  $\text{OFF}_{\text{target}}$  reported by the UE is the one defined in [FDD - 13], [TDD - 14] for this case.

CR-Form-v7
<b>CHANGE REQUEST</b>
⌘ <b>25.420 CR 47</b> ⌘ rev <b>-</b> ⌘ Current version: <b>6.2.0</b> ⌘

For **HELP** on using this form, see bottom of this page or look at the pop-up text over the ⌘ symbols.

**Proposed change affects:** UICC apps  ME  Radio Access Network  Core Network

<b>Title:</b>	⌘ Introduction of Fractional DPCH	
<b>Source:</b>	⌘ RAN3	
<b>Work item code:</b>	⌘ RANimp-RABSE-CodeOptFDD	<b>Date:</b> ⌘ 14/02/2005
<b>Category:</b>	⌘ <b>B</b>	<b>Release:</b> ⌘ Rel-6
	Use <u>one</u> of the following categories: <b>F</b> (correction) <b>A</b> (corresponds to a correction in an earlier release) <b>B</b> (addition of feature), <b>C</b> (functional modification of feature) <b>D</b> (editorial modification) Detailed explanations of the above categories can be found in 3GPP <a href="#">TR 21.900</a> .	Use <u>one</u> of the following releases: 2 (GSM Phase 2) R96 (Release 1996) R97 (Release 1997) R98 (Release 1998) R99 (Release 1999) Rel-4 (Release 4) Rel-5 (Release 5) Rel-6 (Release 6)

<b>Reason for change:</b>	⌘ Introduction of the Fractional DPCH functionality over the lur.
<b>Summary of change:</b>	⌘ Introduction of the Fractional DPCH functionality over the lur.
<b>Consequences if not approved:</b>	⌘ Fractional DPCH will not be included in the specifications.

<b>Clauses affected:</b>	⌘ 3.2, 4.3.2, 6.2.1					
<b>Other specs</b>	<table border="1" style="display: inline-table; vertical-align: middle;"> <tr> <td style="width: 20px; text-align: center;">Y</td> <td style="width: 20px; text-align: center;">N</td> </tr> <tr> <td style="text-align: center;">X</td> <td></td> </tr> </table> Other core specifications	Y	N	X		⌘
Y	N					
X						
<b>affected:</b>	<table border="1" style="display: inline-table; vertical-align: middle;"> <tr> <td style="width: 20px; text-align: center;">X</td> <td>Test specifications</td> </tr> <tr> <td style="width: 20px; text-align: center;">X</td> <td>O&amp;M Specifications</td> </tr> </table>	X	Test specifications	X	O&M Specifications	⌘ CR 194 on 25.211 v 6.3.0 CR 193 on 25.212 v 6.3.0 CR 70 on 25.213 v 6.1.0 CR 357 on 25.214 v 6.4.0 CR 148 on 25.215 v 6.1.0 CR 46 on 25.402 v 6.1.0 CR 1036 on 25.423 v 6.4.1 CR 59 on 25.430 v 6.3.0 CR 1082 on 25.433 v 6.4.0
X	Test specifications					
X	O&M Specifications					
<b>Other comments:</b>	⌘					

**How to create CRs using this form:**

Comprehensive information and tips about how to create CRs can be found at <http://www.3gpp.org/specs/CR.htm>. Below is a brief summary:

- 1) Fill out the above form. The symbols above marked ⌘ contain pop-up help information about the field that they are closest to.
- 2) Obtain the latest version for the release of the specification to which the change is proposed. Use the MS Word "revision marks" feature (also known as "track changes") when making the changes. All 3GPP specifications can be downloaded from the 3GPP server under <ftp://ftp.3gpp.org/specs/> For the latest version, look for the directory name with the latest date e.g. 2001-03 contains the specifications resulting from the March 2001 TSG meetings.
- 3) With "track changes" disabled, paste the entire CR form (use CTRL-A to select it) into the specification just in front of the clause containing the first piece of changed text. Delete those parts of the specification which are not relevant to the change request.

## 3.2 Abbreviations

For the purposes of the present document, the following abbreviations apply:

AAL2	ATM Adaptation Layer type 2
AAL5	ATM Adaptation Layer type 5
ALCAP	Access Link Control Application Part
ATM	Asynchronous Transfer Mode
BSS	Base Station Subsystem
CPCH	Common Packet Channel
CRNC	Controlling RNC
CTP	Common Transport Protocol
DCH	Dedicated Transport Channel
DL	Downlink
<u>DPCH</u>	<u>Dedicated Physical Channel</u>
DRNC	Drift Radio Network Controller
DRNS	Drift Radio Network Subsystem
DSCH	Downlink Shared Channel
E-DCH	Enhanced Dedicated Channel
EDGE	Enhanced Data rates for GSM Evolution
FACH	Forward Access Channel
<u>F-DPCH</u>	<u>Fractional DPCH</u>
FFS	For Further Study
GERAN	GSM/EDGE Radio Access Network
GSM	Global System for Mobile communications
GT	Global Title
HARQ	Hybrid Automatic Repeat Request
HS-DSCH	High Speed Downlink Shared Channel
IP	Internet Protocol
MAC	Medium Access Control
MBMS	Multimedia Broadcast Multicast Service
MTP3-B	Message Transfer Part level 3 (for Q.2140)
PLMN	Public Land Mobile Network
PTM	Point To Multipoint
PTP	Point To Point
QoS	Quality of Service
RACH	Random Access Channel
RF	Radio Frequency
RNC	Radio Network Controller
RNS	Radio Network Subsystem
RNSAP	Radio Network Subsystem Application Part
RRC	Radio Resource Control
SCCP	Signalling Connection Control Part
SPC	Signalling Point Code
SRNC	Serving Radio Network Controller
SRNS	Serving Radio Network Subsystem
SS7	Signalling System N <sup>o</sup> 7
SSCF-NNI	Service Specific Co-ordination Function – Network Node Interface
SSCOP	Service Specific Connection Oriented Protocol
SSN	Sub-System Number
STC	Signalling Transport Converter
UDP	User Datagram Protocol
UE	User Equipment
UL	Up-link
UMTS	Universal Mobile Telecommunication System
URA	UTRAN Registration Area
USCH	Uplink Shared Channel
UTRAN	UMTS Terrestrial Radio Access Network

### 4.3.2 Addressing of RNSs over the Iur Interface

- For an RRC connection using a dedicated channel [or for a UE using F-DPCH in the downlink](#), the Iur standard shall allow the addition / deletion of radio links supported by cells belonging to any RNS within the PLMN.
- The specification of the Iur interface shall allow an RNC to address any other RNC within the PLMN for establishing a signalling bearer over Iur.
- The specification of the Iur interface shall allow an RNC to address any other RNC within the PLMN for establishing user data bearers for Iur data streams.

RNSAP shall allow different kinds of addressing schemes to be used for the signalling bearer.

**UNCHANGED TEXT IS REMOVED**

### 6.2.1 RNSAP Protocol

The protocol responsible for providing signalling information across the Iur interface is called the Radio Network Subsystem Application Part (RNSAP). A subset of RNSAP is used over the Iur-g interface.

The RNSAP is terminated by the two RNCs inter-connected via the Iur interface RNSAP Procedure Modules. In addition, the RNSAP is terminated by a RNC and a BSS supporting Iu mode inter-connected via the Iur-g interface.

RNSAP procedures are divided into four modules as follows:

1. RNSAP Basic Mobility Procedures;
2. RNSAP ~~DCH~~[Dedicated](#) Procedures;
3. RNSAP Common Transport Channel Procedures;
4. RNSAP Global Procedures;
5. RNSAP MBMS Procedures.

The Basic Mobility Procedures module contains procedures used to handle the mobility within UTRAN as well as to handle mobility in case of UTRAN/GERAN interworking.

The ~~DCH~~[Dedicated](#) Procedures module contains procedures that are used to handle DCHs, [\[FDD – F-DPCH,\] DSCH](#), HS-DSCH, [FDD E-DCH] and [TDD - USCHs] between two RNSs. If procedures from this module are not used in a specific Iur, then the usage of DCH, [\[FDD – F-DPCH,\] DSCH](#), HS-DSCH, [FDD E-DCH] and [TDD - USCH] traffic between corresponding RNSs is not possible.

The Common Transport Channel Procedures module contains procedures that are used to control common transport channel data streams (excluding the DSCH, HS-DSCH, E-DCH and USCH) over Iur interface.

The Global Procedures module contains procedures that are not related to a specific UE. The procedures in this module are in contrast to the above modules involving two peer CRNCs. The procedures in this module are also used in cases involving one RNC and one BSS.

The MBMS Procedures module contains procedures that are specific to MBMS and used for cases that cannot be handled by other modules.

## CHANGE REQUEST

# **25.423 CR 1036** # rev **1** # Current version: **6.4.1** #

For **HELP** on using this form, see bottom of this page or look at the pop-up text over the # symbols.

**Proposed change affects:** UICC apps  ME  Radio Access Network  Core Network

<b>Title:</b>	# Introduction of Fractional DPCH		
<b>Source:</b>	# RAN3		
<b>Work item code:</b>	# RANimp-RABSE-CodeOptFDD	<b>Date:</b>	# 18/02/2005
<b>Category:</b>	# <b>B</b>	<b>Release:</b>	# Rel-6
	Use <u>one</u> of the following categories: <b>F</b> (correction) <b>A</b> (corresponds to a correction in an earlier release) <b>B</b> (addition of feature), <b>C</b> (functional modification of feature) <b>D</b> (editorial modification) Detailed explanations of the above categories can be found in 3GPP <a href="#">TR 21.900</a> .		Use <u>one</u> of the following releases: Ph2 (GSM Phase 2) R96 (Release 1996) R97 (Release 1997) R98 (Release 1998) R99 (Release 1999) Rel-4 (Release 4) Rel-5 (Release 5) Rel-6 (Release 6) Rel-7 (Release 7)

<b>Reason for change:</b>	# Introduction of the Fractional DPCH functionality over the lur.
<b>Summary of change:</b>	# Rev 1: Updates to introduce the "alternative" solution in replacement of the default solution. Rev 0: Introduction of the Fractional DPCH functionality in RNSAP based on the default solution.
<b>Consequences if not approved:</b>	#

<b>Clauses affected:</b>	# 3.3, 5.1, 8.3, 8.3.1.2, 8.3.1.3, 8.3.1.4, 8.3.2.2, 8.3.2.3, 8.3.2.4, 8.3.4.2, 8.3.4.3, 8.3.4.4, 8.3.5.2, 8.3.7.2, 8.3.16.2, 8.3.20.2, 9.1.3.1, 9.1.6.1, 9.1.11.1, 9.2.1.5, 9.2.1.21A, 9.2.2.D, 9.2.2.1, 9.2.2.10A, 9.2.2.10C, 9.2.2.14A, 9.2.2.30, 9.2.2.45, 9.3.3, 9.3.4, 9.3.6				
<b>Other specs</b>	<table style="display: inline-table; vertical-align: middle;"> <tr> <td style="border: 1px solid black; padding: 2px;">Y</td> <td style="border: 1px solid black; padding: 2px;">N</td> </tr> <tr> <td style="border: 1px solid black; padding: 2px; text-align: center;">X</td> <td style="border: 1px solid black; padding: 2px;"></td> </tr> </table> Other core specifications # CR 194 on 25.211 v 6.3.0 CR 193 on 25.212 v 6.3.0 CR 70 on 25.213 v 6.1.0 CR 357 on 25.214 v 6.4.0 CR 148 on 25.215 v 6.1.0 CR 46 on 25.402 v 6.1.0 CR 47 on 25.420 v 6.2.0 CR 59 on 25.430 v 6.3.0 CR 1082 on 25.433 v 6.4.0	Y	N	X	
Y	N				
X					

**affected:**

<input checked="" type="checkbox"/>	Test specifications
<input checked="" type="checkbox"/>	O&M Specifications

**Other comments:** ☞

**How to create CRs using this form:**

Comprehensive information and tips about how to create CRs can be found at <http://www.3gpp.org/specs/CR.htm>.

Below is a brief summary:

- 1) Fill out the above form. The symbols above marked ☞ contain pop-up help information about the field that they are closest to.
- 2) Obtain the latest version for the release of the specification to which the change is proposed. Use the MS Word "revision marks" feature (also known as "track changes") when making the changes. All 3GPP specifications can be downloaded from the 3GPP server under <ftp://ftp.3gpp.org/specs/> For the latest version, look for the directory name with the latest date e.g. 2001-03 contains the specifications resulting from the March 2001 TSG meetings.
- 3) With "track changes" disabled, paste the entire CR form (use CTRL-A to select it) into the specification just in front of the clause containing the first piece of changed text. Delete those parts of the specification which are not relevant to the change request.

### 3.3 Abbreviations

For the purposes of the present document, the following abbreviations apply:

A-GPS	Assisted-GPS
ALCAP	Access Link Control Application Part
APN	Access Point Name
ASN.1	Abstract Syntax Notation One
BER	Bit Error Rate
BLER	Block Error Rate
BSS	Base Station Subsystem
CBSS	Controlling BSS
CCCH	Common Control Channel
CCPCH	Common Control Physical Channel
CCTrCH	Coded Composite Transport Channel
CFN	Connection Frame Number
C-ID	Cell Identifier
CM	Compressed Mode
CN	Core Network
CPCH	Common Packet Channel
CPICH	Common Pilot Channel
CRNC	Controlling RNC
DBSS	Drift BSS
C-RNTI	Cell Radio Network Temporary Identifier
CS	Circuit Switched
CTFC	Calculated Transport Format Combination DCH Dedicated Channel
DGPS	Differential GPS
DL	Downlink
DPC	Downlink Power Control
DPCCH	Dedicated Physical Control Channel
DPCH	Dedicated Physical Channel
DPDCH	Dedicated Physical Data Channel
DRAC	Dynamic Radio Access Control
DRNC	Drift RNC
DRNS	Drift RNS
D-RNTI	Drift Radio Network Temporary Identifier
DRX	Discontinuous Reception
DSCH	Downlink Shared Channel
$E_c$	Energy in single Code
E-DCH	Enhanced UL DCH
EDSCHPC	Enhanced Downlink Shared Channel Power Control
EP	Elementary Procedure
FACH	Forward Access Channel
FDD	Frequency Division Duplex
<a href="#">F-DPCH</a>	<a href="#">Fractional DPCH</a>
FN	Frame Number
FP	Frame Protocol
GERAN	GSM EDGE Radio Access Network
GA	Geographical Area
GAI	Geographical Area Identifier
GPS	Global Positioning System
GRA	GERAN Registration Area
GSM	Global System Mobile
HSDPA	High Speed Downlink Packet Access
HW	Hardware
IB	Information Block
ID	Identity or Identifier
IE	Information Element
IMSI	International Mobile Subscriber Identity
IP	Internet Protocol
IPDL	Idle Period DownLink



ISCP	Interference Signal Code Power
LAC	Location Area Code
LCR	Low Chip Rate (1.28 Mcps)
LCS	Location Services
MAC	Medium Access Control
MBMS	Multimedia Broadcast Multicast Service
MS	Mobile Station
NACC	Network Assisted Cell Change
NAS	Non Access Stratum
No	Reference Noise
NRT	Non Real Time
O&M	Operation and Maintenance
P(-)CCPCH	Primary CCPCH
PCH	Paging Channel
OTD	Observed Time Difference
P(-)CPICH	Primary CPICH
PCPCH	Physical Common Packet Channel
PCS	Personal Communication Services
PDSCH	Physical Downlink Shared Channel
PDU	Protocol Data Unit
PhCH	Physical Channel
PICH	Paging Indication Channel
Pos	Position or Positioning
PRACH	Physical Random Access Channel
PTP	Point To Point
PTM	Point To Multipoint
PS	Packet Switched
QE	Quality Estimate
RAC	Routing Area Code
RACH	Random Access Channel
RAN	Radio Access Network
RANAP	Radio Access Network Application Part
RB	Radio Bearer
RL	Radio Link
RLC	Radio Link Control
RLS	Radio Link Set
RM	Rate Matching
RNC	Radio Network Controller
RNS	Radio Network Subsystem
RNSAP	Radio Network Subsystem Application Part
RNTI	Radio Network Temporary Identifier
RRC	Radio Resource Control
RT	Real Time
RSCP	Received Signal Code Power
SBSS	Serving BSS
Rx	Receive or Reception
Sat	Satellite
SCCP	Signalling Connection Control Part
S(-)CCPCH	Secondary CCPCH
SCH	Synchronisation Channel
SCTD	Space Code Transmit Diversity
SDU	Service Data Unit
SF	System Frame
SFN	System Frame Number
SHCCH	Shared Control Channel
SIR	Signal-to-Interference Ratio
SNA	Shared Network Area
SRB2	Signalling radio bearer 2
SRNC	Serving RNC
SRNS	Serving RNS
S-RNTI	Serving Radio Network Temporary Identifier
SSDT	Site Selection Diversity Transmission

STTD	Space Time Transmit Diversity
TDD	Time Division Duplex
TF	Transport Format
TFCI	Transport Format Combination Indicator
TFCS	Transport Format Combination Set
TFS	Transport Format Set
TGCFN	Transmission Gap Connection Frame Number
TMGI	Temporary Mobile Group Identity
ToAWE	Time of Arrival Window Endpoint
ToAWS	Time of Arrival Window Startpoint
TPC	Transmit Power Control
TrCH	Transport Channel
TS	Time Slot
TSG	Technical Specification Group
TSTD	Time Switched Transmit Diversity
TTI	Transmission Time Interval
TX	Transmit or Transmission
UARFCN	UTRA Absolute Radio Frequency Channel Number
UDP	User Datagram Protocol
UC-ID	UTRAN Cell Identifier
UE	User Equipment
UL	Uplink
UMTS	Universal Mobile Telecommunications System
URA	UTRAN Registration Area
U-RNTI	UTRAN Radio Network Temporary Identifier
USCH	Uplink Shared Channel
UTRA	Universal Terrestrial Radio Access
UTRAN	Universal Terrestrial Radio Access Network

---

## 5 RNSAP Services

### 5.1 RNSAP Procedure Modules

The Iur interface RNSAP procedures are divided into four modules as follows:

1. RNSAP Basic Mobility Procedures;
2. RNSAP Dedicated Procedures;
3. RNSAP Common Transport Channel Procedures;
4. RNSAP Global Procedures;
5. RNSAP MBMS Procedures.

The Basic Mobility Procedures module contains procedures used to handle the mobility within UTRAN, within GERAN and between UTRAN and GERAN.

The Dedicated Procedures module contains procedures that are used to handle DCHs, [\[FDD – F-DPCH,\] DSCHs](#), and USCHs between two RNSs. If procedures from this module are not used in a specific Iur, then the usage of DCH, [\[FDD – F-DPCH,\] DSCH](#), and USCH traffic between corresponding RNSs is not possible.

The Common Transport Channel Procedures module contains procedures that are used to control common transport channel data streams (excluding the DSCH and USCH) over Iur interface.

The Global Procedures module contains procedures that are not related to a specific UE. The procedures in this module are in contrast to the above modules involving two peer CRNCs/CBSSs.

The MBMS Procedures module contains procedures that are specific to MBMS and used for cases that cannot be handled by other modules.

### 5.2 Parallel Transactions

Unless explicitly indicated in the procedure specification, at any instance in time one protocol peer shall have a maximum of one ongoing RNSAP DCH procedure related to a certain UE.

## 8.3.1 Radio Link Setup

### 8.3.1.1 General

This procedure is used for establishing the necessary resources in the DRNS for one or more radio links.

The connection-oriented service of the signalling bearer shall be established in conjunction with this procedure.

### 8.3.1.2 Successful Operation

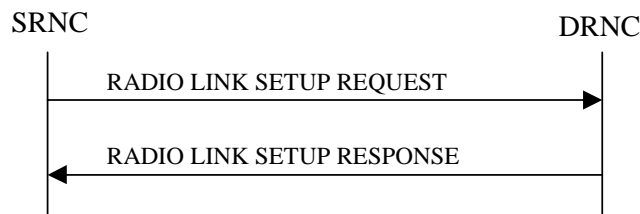

**Figure 5: Radio Link Setup procedure: Successful Operation**

When the SRNC makes an algorithmic decision to add the first cell or set of cells from a DRNS to the active set of a specific UE-UTRAN connection, the RADIO LINK SETUP REQUEST message is sent to the corresponding DRNC to request establishment of the radio link(s). The Radio Link Setup procedure is initiated with this RADIO LINK SETUP REQUEST message sent from the SRNC to the DRNC.

Upon receipt of the RADIO LINK SETUP REQUEST message, the DRNS shall reserve the necessary resources and configure the new RL(s) according to the parameters given in the message. Unless specified below, the meaning of parameters is specified in other specifications.

The DRNS shall prioritise resource allocation for the RL(s) to be established according to Annex A.

If the RADIO LINK SETUP REQUEST message includes the *Allowed Queuing Time* IE the DRNS may queue the request for a time period not to exceed the value of the *Allowed Queuing Time* IE before starting to execute the request.

#### Transport Channels Handling:

##### DCH(s):

[TDD - If the *DCH Information* IE is present in the RADIO LINK SETUP REQUEST message, the DRNS shall configure the new DCHs according to the parameters given in the message.]

If the RADIO LINK SETUP REQUEST message includes a *DCH Information* IE with multiple *DCH Specific Info* IEs, then the DRNS shall treat the DCHs in the *DCH Information* IE as a set of co-ordinated DCHs.

If the *DCH Specific Info* IE includes the *Unidirectional DCH Indicator* IE set to "Uplink DCH only", the DRNS shall ignore the *Transport Format Set* IE for the downlink for this DCH. As a consequence this DCH is not included as a part of the downlink CCTrCH.

[TDD - If the *DCH Specific Info* IE includes the *Unidirectional DCH Indicator* IE set to "Downlink DCH only", the DRNS shall ignore the *Transport Format Set* IE for the uplink for this DCH. As a consequence this DCH is not included as a part of the uplink CCTrCH.]

[FDD - For each DCH which do not belong to a set of co-ordinated DCHs, and which includes a *QE-Selector* IE set to "selected", the DRNS shall use the Transport channel BER from that DCH for the QE in the UL data frames. If no Transport channel BER is available for the selected DCH, the DRNS shall use the Physical channel BER for the QE, ref. [4]. If the *QE-Selector* IE is set to "non-selected", the DRNS shall use the Physical channel BER for the QE in the UL data frames, ref. [4].]

For a set of co-ordinated DCHs, the DRNS shall use the Transport channel BER from the DCH with the *QE-Selector* IE set to "selected" for the QE in the UL data frames, ref. [4]. [FDD - If no Transport channel BER is available for the selected DCH, the DRNS shall use the Physical channel BER for the QE, ref. [4]. If all DCHs have *QE-Selector* IE set to "non-selected", the DRNS shall use the Physical channel BER for the QE,

ref. [4].] [TDD - If no Transport channel BER is available for the selected DCH, the DRNS shall use 0 for the QE, ref. [4].]

The DRNS shall use the included *UL DCH FP Mode* IE for a DCH or a set of co-ordinated DCHs as the DCH FP Mode in the Uplink of the user plane for the DCH or the set of co-ordinated DCHs.

The DRNS shall use the included *ToAWS* IE for a DCH or a set of co-ordinated DCHs as the Time of Arrival Window Startpoint in the user plane for the DCH or the set of co-ordinated DCHs.

The DRNS shall use the included *ToAWE* IE for a DCH or a set of co-ordinated DCHs as the Time of Arrival Window Endpoint in the user plane for the DCH or the set of co-ordinated DCHs.

The *Frame Handling Priority* IE defines the priority level that should be used by the DRNS to prioritise between different frames of the data frames of the DCHs in the downlink on the radio interface in congestion situations once the new RL(s) have been activated.

The *Traffic Class* IE may be used to determine the transport bearer characteristics to apply between DRNC and Node B for the related DCH or set of co-ordinated DCHs. The DRNC should ignore the *Traffic Class* IE if the *TrCH Source Statistics Descriptor* IE indicates the value "RRC".

If the *TNL QoS* IE is included for a DCH or a set of co-ordinated DCHs and if ALCAP is not used, the *TNL QoS* IE may be used by the DRNS to determine the transport bearer characteristics to apply in the uplink for the related DCH or set of co-ordinated DCHs.

If the *DCH Information* IE contains a *DCH Specific Info* IE which includes the *Guaranteed Rate Information* IE, the DRNS shall treat the included IEs according to the following:

- If the *Guaranteed Rate Information* IE includes the *Guaranteed UL Rate* IE, the DRNS shall apply the Guaranteed Rate in the uplink of this DCH. The DRNS may decide to request the SRNC to limit the user rate of the uplink of the DCH at any point in time. The DRNS may request the SRNC to reduce the user rate of the uplink of the DCH below the guaranteed bit rate, however, whenever possible the DRNS should request the SRNC to only reduce the user rate between the maximum bit rate and the guaranteed bit rate. If the *DCH Specific Info* IE in the *DCH Information* IE does not include the *Guaranteed UL Rate* IE, the DRNS shall not limit the user rate of the uplink of the DCH.
- If the *Guaranteed Rate Information* IE includes the *Guaranteed DL Rate* IE, the DRNS shall apply the Guaranteed Rate in the downlink of this DCH. The DRNS may decide to request the SRNC to limit the user rate of the downlink of the DCH at any point in time. The DRNS may request the SRNC to reduce the user rate of the downlink of the DCH below the guaranteed bit rate, however, whenever possible the DRNS should request the SRNC to only reduce the user rate between the maximum bit rate and the guaranteed bit rate. If the *DCH Specific Info* IE in the *DCH Information* IE does not include the *Guaranteed DL Rate* IE, the DRNS shall not limit the user rate of the downlink of the DCH.

#### **DSCH(s):**

If the *DSCH Information* IE is included in the RADIO LINK SETUP REQUEST message, the DRNC shall establish the requested DSCHs [FDD - on the RL indicated by the PDSCH RL ID IE]. If the *Transport Layer Address* IE and *Binding ID* IE are included in the *DSCH Information* IE the DRNC may use the transport layer address and the binding identifier received from the SRNC when establishing a transport bearer for the DSCH. In addition, the DRNC shall send a valid set of *DSCH Scheduling Priority* IE and *MAC-c/sh SDU Length* IE parameters to the SRNC in the RADIO LINK SETUP RESPONSE message. If the *PDSCH RL ID* IE indicates a radio link in the DRNS, then the DRNC shall allocate a DSCH-RNTI to the UE Context and include the *DSCH-RNTI* IE in the RADIO LINK SETUP RESPONSE message.

If the *DSCH Information* IE is included in the RADIO LINK SETUP REQUEST message, the DRNS may use the *Traffic Class* IE to determine the transport bearer characteristics to apply between DRNC and Node B for the related DSCHs.

The DRNC shall include the *DSCH Initial Window Size* IE in the RADIO LINK SETUP RESPONSE message for each DSCH, if the DRNS allows the SRNC to start transmission of MAC-c/sh SDUs before the DRNS has allocated capacity on user plane as described in [32].

#### **[TDD - USCH(s)]:**

[TDD - The DRNS shall use the list of RB Identities in the *RB Info* IE in the *USCH information* IE to map each *RB Identity* IE to the corresponding USCH. If the *Transport Layer Address* IE and *Binding ID* IE are included in the *USCH Information* IE the DRNC may use the transport layer address and the binding identifier received from the SRNC when establishing a transport bearer for the USCH.]

[TDD - If the *USCH Information* IE is included in the RADIO LINK SETUP REQUEST message, the DRNS may use the *Traffic Class* IE to determine the transport bearer characteristics to apply between DRNC and Node B for the related USCHs.]

[TDD - If the *USCH Information* IE is included in the RADIO LINK SETUP REQUEST message and contains the *TNL QoS* IE, and if ALCAP is not used, the DRNS may use the *TNL QoS* IE to determine the transport bearer characteristics to apply in the uplink for the related USCH.]

[TDD - If the *USCH Information* IE is included in the RADIO LINK SETUP REQUEST message, the DRNS shall establish the requested USCHs, and the DRNC shall provide the [3.84 Mcps TDD - *USCH Information Response* IE] [1.28 Mcps TDD - *USCH Information Response LCR* IE] in the RADIO LINK SETUP RESPONSE message.]

#### [TDD - CCTrCH Handling]:

[TDD - If the *UL CCTrCH Information* IE is present in the RADIO LINK SETUP REQUEST message, the DRNS shall configure the new UL CCTrCH(s) according to the parameters given in the message.]

[1.28Mcps TDD - If the *UL CCTrCH Information LCR* IE includes the *TDD TPC Uplink Step Size* IE, the DRNS shall configure the uplink TPC step size according to the parameters given in the message.]

[TDD - If the *DL CCTrCH Information* IE is present in the RADIO LINK SETUP REQUEST message, the DRNS shall configure the new DL CCTrCH(s) according to the parameters given in the message.]

[TDD - If the *TPC CCTrCH List* IE is present in the RADIO LINK SETUP REQUEST message, the DRNS shall configure the identified UL CCTrCHs with TPC according to the parameters given in the message.]

#### HS-DSCH:

If the *HS-DSCH Information* IE is present in the RADIO LINK SETUP REQUEST message, then:

- The DRNS shall setup the requested HS-PDSCH resources on the Serving HS-DSCH Radio Link indicated by the *HS-PDSCH RL ID* IE.
- The DRNC shall include the *HARQ Memory Partitioning* IE in the [FDD – *HS-DSCH FDD Information Response* IE] [TDD – *HS-DSCH TDD Information Response* IE] in the RADIO LINK SETUP RESPONSE message.
- The DRNC shall allocate an HS-DSCH-RNTI to the UE Context and include the *HS-DSCH-RNTI* IE in the RADIO LINK SETUP RESPONSE message.
- The DRNC shall include in the RADIO LINK SETUP RESPONSE message the *Binding ID* IE and *Transport Layer Address* IE for establishment of transport bearer for every HS-DSCH MAC-d flow being established.
- If the RADIO LINK SETUP REQUEST message includes the *Transport Layer Address* IE and *Binding ID* IE in the *HS-DSCH Information* IE for an HS-DSCH MAC-d flow, then the DRNC may use the transport layer address and the binding identifier received from the SRNC when establishing a transport bearer for the concerned HS-DSCH MAC-d flow.
- The DRNS may use the *Traffic Class* IE for a specific HS-DSCH MAC-d flow to determine the transport bearer characteristics to apply between DRNC and Node B.
- If the RADIO LINK SETUP REQUEST message includes the *MAC-hs Guaranteed Bit Rate* IE for a Priority Queue in the *HS-DSCH MAC-d Flows Information* IE in the *HS-DSCH Information* IE, then the DRNS shall use this information to optimise MAC-hs scheduling decisions for the related HSDPA Priority Queue.
- If the RADIO LINK SETUP REQUEST message includes the *Discard Timer* IE for a Priority Queue in the *HS-DSCH MAC-d Flows Information* IE in the *HS-DSCH Information* IE, then the DRNS shall use this information to discard out-of-date MAC-hs SDUs from the related HSDPA Priority Queue.

- The DRNC shall include the *HS-DSCH Initial Capacity Allocation IE* in the [FDD – *HS-DSCH FDD Information Response IE*] [TDD – *HS-DSCH TDD Information Response IE*] in the RADIO LINK SETUP RESPONSE message for every HS-DSCH MAC-d flow being established, if the DRNS allows the SRNC to start transmission of MAC-d PDUs before the DRNS has allocated capacity on user plane as described in [32].
- [FDD - If the RADIO LINK SETUP REQUEST message includes the *HS-SCCH Power Offset IE* in the *HS-DSCH Information IE*, then the DRNS may use this value to determine the HS-SCCH power. The HS-SCCH Power Offset should be applied for any HS-SCCH transmission to this UE.]
- [FDD - The DRNC shall include the *Measurement Power Offset IE* in the *HS-DSCH Information Response IE* in the RADIO LINK SETUP RESPONSE message.]
- [FDD - The DRNS shall allocate HS-SCCH codes corresponding to the HS-DSCH and the DRNC shall include the *HS-SCCH Specific Information Response IE* in the *HS-DSCH FDD Information Response IE* in the RADIO LINK SETUP RESPONSE message.]
- [TDD - The DRNS shall allocate HS-SCCH parameters corresponding to the HS-DSCH and the DRNC shall include the [3.84Mcps TDD - *HS-SCCH Specific Information Response IE*] [1.28Mcps TDD - *HS-SCCH Specific Information Response LCR IE*] in the *HS-DSCH TDD Information Response IE* in the RADIO LINK SETUP RESPONSE message.]
- [TDD - The DRNC shall include the [3.84 Mcps TDD - *HS-PDSCH Timeslot Specific Information IE*] [1.28 Mcps TDD - *HS-PDSCH Timeslot Specific Information LCR IE*] in the *HS-DSCH Information Response IE* in the RADIO LINK SETUP RESPONSE message.]
- [FDD - The DRNC shall include the *HS-PDSCH And HS-SCCH Scrambling Code IE* in the *HS-DSCH FDD Information Response IE* in the RADIO LINK SETUP RESPONSE message.]
- [FDD – If the RADIO LINK SETUP REQUEST message includes the *HARQ Preamble Mode IE* in the *HS-DSCH Information IE*, then the DRNS shall use the indicated HARQ Preamble Mode as described in [10].]

#### [FDD - E-DCH:

If the *E-DCH FDD Information IE* is present in the RADIO LINK SETUP REQUEST message and the *RL Information IE* contains the *RL specific E-DCH Information IE* for one Radio Link then:

- The DRNS shall setup the requested E-DCH resources on the Radio Link indicated by the *RL ID IE* in the *RL Information IE*.
- The RADIO LINK SETUP REQUEST message shall contain in the *RL Information IE* for every RL the *E-DCH RL Indication IE* indicates whether this RL has configured E-DCH resources.
- If the RADIO LINK SETUP REQUEST message includes the *Transport Layer Address IE* and *Binding ID IE* in the *RL specific E-DCH Information IE* for an E-DCH MAC-d flow, then the DRNC may use the transport layer address and the binding identifier received from the SRNC when establishing a transport bearer for the concerned E-DCH MAC-d flow.
- The DRNS may use the *Traffic Class IE* for a specific E-DCH MAC-d flow to determine the transport bearer characteristics to apply between DRNC and Node B.
- If the RADIO LINK SETUP REQUEST message includes the *MAC-e Guaranteed Bit Rate IE* for a E-DCH MAC-d flow in the *E-DCH MAC-d Flow Specific Information IE* in the *E-DCH FDD Information IE*, then the DRNS shall use this information to optimise MAC-e scheduling decisions.
- If the RADIO LINK SETUP REQUEST message includes the *Maximum Number of Retransmissions for E-DCH IE* for a E-DCH MAC-d flow in the *E-DCH MAC-d Flow Specific Information IE* in the *E-DCH FDD Information IE*, then the DRNS shall use this information to report if the maximum number of retransmissions has elapsed.
- If the *TNL QoS IE* is included for a E-DCH MAC-d flow and if ALCAP is not used, the *TNL QoS IE* may be used by the DRNS to determine the transport bearer characteristics to apply in the uplink for the related MAC-d flow.

- The DRNC shall include the *E-AGCH and E-RGCH and E-HICH FDD Scrambling Code IE* and the *E-RGCH and E-HICH Channelisation Code IE* and the corresponding *Sequence Number for E-RGCH IE* and the *Sequence Number for E-HICH IE* in the *E-DCH FDD DL Control Channel Information IE* in the RADIO LINK SETUP RESPONSE message.
- If the RADIO LINK SETUP REQUEST message contains the *Serving E-DCH RL ID IE* then the DRNC shall allocate an E-RNTI and include this E-RNTI and the Channelisation Code of the corresponding E-AGCH in the *E-DCH FDD DL Control Channel Information IE* in the *RL Information IE* for the indicated RL in the RADIO LINK SETUP RESPONSE message.]

### Physical Channels Handling:

#### [FDD - Compressed Mode]:

[FDD - If the RADIO LINK SETUP REQUEST message includes the *Transmission Gap Pattern Sequence Information IE*, the DRNS shall store the information about the Transmission Gap Pattern Sequences to be used in the Compressed Mode Configuration. This Compressed Mode Configuration shall be valid in the DRNS until the next Compressed Mode Configuration is configured in the DRNS or the last Radio Link is deleted.]

[FDD - If the RADIO LINK SETUP REQUEST message includes the *Transmission Gap Pattern Sequence Information IE* and the *Active Pattern Sequence Information IE*, the DRNS shall use the information to activate the indicated Transmission Gap Pattern Sequence(s) in the new RL. The received *CM Configuration Change CFN IE* refers to latest passed CFN with that value. The DRNS shall treat the received *TGCFN IEs* as follows:]

- [FDD - If any received *TGCFN IE* has the same value as the received *CM Configuration Change CFN IE*, the DRNS shall consider the concerned Transmission Gap Pattern Sequence as activated at that CFN.]
- [FDD - If any received *TGCFN IE* does not have the same value as the received *CM Configuration Change CFN IE* but the first CFN after the *CM Configuration Change CFN* with a value equal to the *TGCFN IE* has already passed, the DRNS shall consider the concerned Transmission Gap Pattern Sequence as activated at that CFN.]
- [FDD - For all other Transmission Gap Pattern Sequences included in the *Active Pattern Sequence Information IE*, the DRNS shall activate each Transmission Gap Pattern Sequence at the first CFN after the *CM Configuration Change CFN* with a value equal to the *TGCFN IE* for the Transmission Gap Pattern Sequence.]

[FDD - If the *Downlink Compressed Mode Method IE* in one or more Transmission Gap Pattern Sequence is set to "SF/2" in the RADIO LINK SETUP REQUEST message and the UE Context is configured to use DPCH in the downlink, the DRNS shall include the *Transmission Gap Pattern Sequence Scrambling Code Information IE* in the RADIO LINK SETUP RESPONSE message indicating for each DL Channelisation Code whether the alternative scrambling code shall be used or not.]

[FDD - If the RADIO LINK SETUP REQUEST message includes the *Transmission Gap Pattern Sequence Information IE* and the *Active Pattern Sequence Information IE* and the concerned UE Context is configured to use F-DPCH in the downlink, the DRNS shall ignore, when activating the Transmission Gap Pattern Sequence(s), the information provided by the *Downlink Compressed Mode Method IE* if included for the concerned Transmission Gap Pattern Sequence(s).]

#### [FDD - DL Code Information]:

[FDD - When more than one DL DPDCH are assigned per RL, the segmented physical channel shall be mapped on to DL DPDCHs according to [8]. When  $p$  number of DL DPDCHs are assigned to each RL, the first pair of DL Scrambling Code and FDD DL Channelisation Code Number corresponds to "*PhCH number 1*", the second to "*PhCH number 2*", and so on until the  $p$ th to "*PhCH number p*".]

#### [FDD – Phase Reference Handling]:

[FDD – If the RADIO LINK SETUP REQUEST message includes the *UE Support Of Dedicated Pilots For Channel Estimation IE*, the DRNC shall assume that dedicated pilots may be used for channel estimation for DCH or DSCH.]



[FDD – If the RADIO LINK SETUP REQUEST message includes the *UE Support Of Dedicated Pilots For Channel Estimation Of HS-DSCH* IE, the DRNC shall assume that dedicated pilots may be used for channel estimation for HS-DSCH.]

[FDD – If Primary CPICH is not to be used as a Phase Reference for this Radio Link, the DRNC shall include the *Primary CPICH Usage For Channel Estimation* IE set to the value "Primary CPICH shall not be used" in the RADIO LINK SETUP RESPONSE message.]

[FDD – If Secondary CPICH may be used as a Phase Reference for this Radio Link, the DRNC shall include the *Secondary CPICH Information* IE in the RADIO LINK SETUP RESPONSE message.]

#### **General:**

[FDD - If the *Propagation Delay* IE is included, the DRNS may use this information to speed up the detection of UL synchronisation on the Uu interface.]

[FDD - If the received *Limited Power Increase* IE is set to "Used", the DRNS shall, if supported, use Limited Power Increase according to ref. [10] subclause 5.2.1 for the inner loop DL power control.]

[FDD - If the RADIO LINK SETUP REQUEST message does not include the *Length of TFCI2* IE and the *Split type* IE is present with the value "Hard", then the DRNS shall assume the length of the TFCI (field 2) is 5 bits.]

[FDD - If the RADIO LINK SETUP REQUEST message includes *Split Type* IE, then the DRNS shall apply this information to the new configuration of TFCI.]

[FDD - If the RADIO LINK SETUP REQUEST message includes the *Length of TFCI2* IE, the DRNS shall apply this information to the length of TFCI(field 2).]

[TDD - If the RADIO LINK SETUP REQUEST message includes the *Maximum Number of DL Physical Channels per Timeslot* IE the DRNC shall take this value into account when allocating physical resources, otherwise the DRNC can assume that this UE capability is consistent with the other signalled UE capabilities.]

[1.28Mcps TDD - If the RADIO LINK SETUP REQUEST message includes the *Support for 8PSK* IE within the *DL Physical Channel Information* IE or *UL Physical Channel Information* IE, the DRNC shall take this into account in the specified direction when allocating physical resources, otherwise the DRNC can assume that this UE does not support 8PSK resource allocation.]

[FDD – If the RADIO LINK SETUP REQUEST message includes the *DL DPCH Information* IE, then the DRNS shall configure the concerned UE Context to use DPCH in the downlink, i.e. with a DL DPCCCH and a DL DPDCH.]

[FDD – If the RADIO LINK SETUP REQUEST message includes the *F-DPCH Information* IE, then the DRNS shall configure the concerned UE Context to use F-DPCH in the downlink, i.e. with transmission of only the TPC field.]

#### **[FDD - E-DPCH Handling:**

If the *E-DPCH Information* IE is included, the *UL DPDCH Indicator for E-DCH operation* IE in the *UL DPCH Information* shall be present as well. If the *UL DPDCH Indicator for E-DCH operation* IE is set to "UL DPDCH not present" the *Min UL Channelisation Code Length* IE, the *Puncture Limit* IE and the *TFCS* IE, within the *UL DPCH Information* IE shall be ignored.]

#### **Radio Link Handling:**

##### **Diversity Combination Control:**

[FDD - The *Diversity Control Field* IE indicates for each RL except for the first RL whether the DRNS shall combine the RL with any of the other RLs or not.

- If the *Diversity Control Field* IE is set to "May" (be combined with another RL), the DRNS shall decide for any of the alternatives.
- If the *Diversity Control Field* IE is set to "Must", the DRNS shall combine the RL with one of the other RL.

- If the *Diversity Control Field* IE is set to "Must not", the DRNS shall not combine the RL with any other existing RL.

When an RL is to be combined, the DRNS shall choose which RL(s) to combine it with.]

[FDD - The *Diversity Control Field* IE is only applicable for DCHs, in case of E-DCH it shall always be assumed to be set to "May".]

[FDD - In the RADIO LINK SETUP RESPONSE message, the DRNC shall indicate for each RL with the Diversity Indication in the *RL Information Response* IE whether the RL is combined or not.]

- [FDD - In case of not combining with a RL previously listed in the RADIO LINK SETUP RESPONSE message or for the first RL in the RADIO LINK SETUP RESPONSE message, the DRNC shall
  - in case of requested DCHs, include in the *DCH Information Response* IE in the RADIO LINK SETUP RESPONSE message the *Binding ID* IE and *Transport Layer Address* IE for the transport bearer to be established for each DCH of this RL.
  - in case of a requested E-DCH, include in the E-DCH FDD Information Response IE in the RADIO LINK SETUP RESPONSE message the *Binding ID* IE and the *Transport Layer Address* IE for the establishment of transport bearers for every E-DCH MAC-d flow being established.]
- [FDD - Otherwise in case of combining, the *RL ID* IE indicates (one of) the RL(s) previously listed in this RADIO LINK SETUP RESPONSE message with which the concerned RL is combined.]

[TDD - The DRNC shall always include in the RADIO LINK SETUP RESPONSE message both the *Transport Layer Address* IE and the *Binding ID* IE for the transport bearer to be established for each DCH, DSCH and USCH of the RL.]

In the case of a set of co-ordinated DCHs requiring a new transport bearer the *Binding ID* IE and the *Transport Layer Address* IE shall be included in the RADIO LINK SETUP RESPONSE message for only one of the DCHs in the set of co-ordinated DCHs.

#### [FDD - Transmit Diversity]:

[FDD - If the cell in which the RL is being set up is capable to provide Close loop Tx diversity, the DRNC shall include the *Closed Loop Timing Adjustment Mode* IE in the RADIO LINK SETUP RESPONSE message indicating the configured Closed loop timing adjustment mode of the cell.]

[FDD - When the *Diversity Mode* IE is set to "STTD", "Closed loop mode1", or "Closed loop mode2", the DRNC shall activate/deactivate the Transmit Diversity for each Radio Link in accordance with the *Transmit Diversity Indicator* IE].

#### DL Power Control:

[FDD - If both the *Initial DL TX Power* IE and *Uplink SIR Target* IE are included in the message, the DRNS shall use the indicated DL TX Power and Uplink SIR Target as initial value. If the value of the *Initial DL TX Power* IE is outside the configured DL TX power range, the DRNS shall apply these constraints when setting the initial DL TX power. The DRNS shall also include the configured DL TX power range defined by *Maximum DL TX Power* IE and *Minimum DL TX Power* IE in the RADIO LINK SETUP RESPONSE message. The DRNS shall not transmit with a ~~higher~~ power higher than indicated by the *Maximum DL TX Power* IE or lower than indicated by the *Minimum DL TX Power* IE on any DL DPCH or on the F-DPCH of the RL except, if the UE Context is configured to use DPCH in the downlink, during compressed mode, when the  $\delta P_{curr}$ , as described in ref.[10] subclause 5.2.1.3, shall be added to the maximum DL power for the associated compressed frame.]

[FDD - If both the *Initial DL TX Power* and the *Uplink SIR Target* IEs are not included in the RADIO LINK SETUP REQUEST message, then DRNC shall determine the initial Uplink SIR Target and include it in the *Uplink SIR Target* IE in the RADIO LINK SETUP RESPONSE message.]

[TDD - The DRNC shall use the *Uplink SIR Target CCTrCH* IEs in the RADIO LINK SETUP RESPONSE message to indicate for any UL CCTrCH an Uplink SIR Target value in case this is deviating from the value included in the *Uplink SIR Target* IE specified for the Radio Link. If in any [3.84Mcps TDD - *UL CCTrCH Information* IE] [1.28Mcps TDD - *UL CCTrCH Information LCR* IE] the *Uplink SIR Target CCTrCH* IE is not included, the value of the *Uplink SIR Target* IE shall apply to the respective UL CCTrCH.]

[FDD - If the *Primary CPICH Ec/No* IE is present, the DRNC should use the indicated value when deciding the Initial DL TX Power. If the *Enhanced Primary CPICH Ec/No* IE is present, the DRNC should use the indicated value when deciding the Initial DL Tx Power.]

[TDD - If [3.84Mcps TDD - the *DL Time Slot ISCP Info* IE] [1.28Mcps TDD - the *DL Time Slot ISCP Info LCR* IE] is present, the DRNS should use the indicated value when deciding the Initial DL TX Power for the Radio Link. The DRNS shall use the indicated DL Timeslot ISCP when determining the initial DL power per timeslot as specified in [22], i.e. it shall reduce the DL TX power in those downlink timeslots of the radio link where the interference is low, and increase the DL TX power in those timeslots where the interference is high, while keeping the total downlink power in the radio link unchanged.]

[TDD - If the *Primary CCPCH RSCP Delta* IE is included, the DRNS should assume that the reported value for Primary CCPCH RSCP is in the negative range as per [24], and the value is equal to the *Primary CCPCH RSCP Delta* IE. If the *Primary CCPCH RSCP Delta* IE is not included and the *Primary CCPCH RSCP* IE is included, the DRNS should assume that the reported value is in the non-negative range as per [24], and the value is equal to the *Primary CCPCH RSCP* IE. The DRNS should use the indicated value when deciding the Initial DL TX Power for the Radio Link.]

[3.84 Mcps TDD - The DL TX power upper and lower limit is configured in the following way: The DRNC shall include the *Maximum DL TX Power* IE and *Minimum DL TX Power* IE in the RADIO LINK SETUP RESPONSE message. If the maximum or minimum power needs to be different for particular DCH type CCTrCHs, the DRNC shall include the value(s) for that CCTrCH in the *CCTrCH Maximum DL TX Power* IE and *CCTrCH Minimum DL TX Power* IE. The DRNS shall not transmit with a higher power than indicated by the appropriate *Maximum DL TX Power* IE/*CCTrCH Maximum DL TX Power* IE or lower than indicated by the appropriate *Minimum DL TX Power* IE/*CCTrCH Minimum DL TX Power* IE on any DL DPCH within each CCTrCH of the RL.]

[1.28 Mcps TDD - The DL TX power upper and lower limit is configured in the following way: The DRNC shall include the *Maximum DL TX Power* IE and *Minimum DL TX Power* IE in the RADIO LINK SETUP RESPONSE message. If the maximum or minimum power needs to be different for particular timeslots within a DCH type CCTrCH, the DRNC shall include the value(s) for that timeslot in the *Maximum DL TX Power* IE and *Minimum DL TX Power* IE within the *DL Timeslot Information LCR* IE. The DRNS shall not transmit with a higher power than indicated by the appropriate *Maximum DL TX Power* IE or lower than indicated by the appropriate *Minimum DL TX Power* IE on any DL DPCH within each timeslot of the RL.]

[1.28McpsTDD - If the *TSTD Support Indicator* IE is present, the DRNS shall apply this information when configuring the transmit diversity for the new radio link.]

[FDD - The DRNS shall start any DL transmission using the indicated DL TX power level (if received) or the decided DL TX power level on each DL channelisation code [or on the F-DPCH](#) of a RL until UL synchronisation is achieved on the Uu interface for the concerned RLS or Power Balancing is activated. No inner loop power control or power balancing shall be performed during this period. The DL power shall then vary according to the inner loop power control (see ref.[10] subclause 5.2.1.2) and the power control procedure (see 8.3.15).]

[TDD - The DRNS shall start any DL transmission using the decided DL TX power level on each DL channelisation code and on each Time Slot of a RL until UL synchronisation is achieved on the Uu interface for the concerned RL. No inner loop power control shall be performed during this period. Then after UL synchronisation, the DL power shall vary according to the inner loop power control (see ref. [22] subclause 4.2.3.3).]

[FDD - If the received *Inner Loop DL PC Status* IE is set to "Active", the DRNS shall activate the inner loop DL power control for all RLS. If *Inner Loop DL PC Status* IE is set to "Inactive", the DRNS shall deactivate the inner loop DL power control for all RLS according to ref. [10].]

[FDD - If the *DPC Mode* IE is present in the RADIO LINK SETUP REQUEST message, the DRNC shall apply the DPC mode indicated in the message, and be prepared that the DPC mode may be changed during the lifetime of the RL. If the *DPC Mode* IE is not present in the RADIO LINK SETUP REQUEST message, DPC mode 0 shall be applied (see ref. [10]).]

[FDD - If the RADIO LINK SETUP REQUEST message includes the *DL Power Balancing Information* IE and the *Power Adjustment Type* IE is set to "Common" or "Individual", the DRNS shall activate the power balancing, if activation of power balancing by the RADIO LINK SETUP REQUEST message is supported, according to subclause 8.3.15, using the *DL Power Balancing Information* IE. If the DRNS starts the DL

transmission and the activation of the power balancing at the same CFN, the initial power of the power balancing i.e.  $P_{init}$  shall be set to the power level indicated by the *Initial DL TX Power IE* (if received) or the decided DL TX power level on each DL channelisation code of a RL based on the *Primary CPICH Ec/No IE* or the *Enhanced Primary CPICH Ec/No IE*.]

[FDD - If activation of power balancing by the RADIO LINK SETUP REQUEST message is supported by the DRNS, the DRNC shall include the *DL Power Balancing Activation Indicator IE* in the *RL Information Response IE* in the RADIO LINK SETUP RESPONSE message.]

#### **Neighbouring Cell Handling:**

If there are UMTS neighbouring cell(s) to the cell in which a Radio Link was established then:

- The DRNC shall include in the RADIO LINK SETUP RESPONSE message the *Neighbouring FDD Cell Information IE* and/or *Neighbouring TDD Cell Information IE* in the *Neighbouring UMTS Cell Information IE* for each neighbouring FDD cell and/or TDD cell respectively. In addition, if the information is available, the DRNC shall include in the RADIO LINK SETUP RESPONSE message the *Frame Offset IE*, *Primary CPICH Power IE*, *Cell Individual Offset IE*, *STTD Support Indicator IE*, *Closed Loop Mode1 Support Indicator IE*, *Closed Loop Mode2 Support Indicator IE*, *Coverage Indicator IE*, *Antenna Co-location Indicator IE* and *HCS Prio IE* in the *Neighbouring FDD Cell Information IE*, and the *Frame Offset IE*, *Cell Individual Offset IE*, *DPCH Constant Value IE*, the *PCCPCH Power IE*, *Coverage Indicator IE*, *Antenna Co-location Indicator IE* and *HCS Prio IE* in the *Neighbouring TDD Cell Information IE* or the *Neighbouring TDD Cell Information LCR IE*. If the *Neighbouring TDD Cell Information IE* includes the *Sync Case IE* for the set to "Case1", the DRNC shall include the *Time Slot For SCH IE* in the *Neighbouring TDD Cell Information IE*. If the *Neighbouring TDD Cell Information IE* includes *Sync Case IE* set to "Case2", the DRNC shall include the *SCH Time Slot IE* in the *Neighbouring TDD Cell Information IE*.
- If a UMTS neighbouring cell is not controlled by the same DRNC, the DRNC shall also include in the RADIO LINK SETUP RESPONSE message the *CN PS Domain Identifier IE* and/or *CN CS Domain Identifier IE* which are the identifiers of the CN nodes connected to the RNC controlling the UMTS neighbouring cell.
- If the information is available, the DRNC shall include in the RADIO LINK SETUP RESPONSE message the *DPC Mode Change Support Indicator IE* for each neighbour cell in the *Neighbouring FDD Cell Information IE*
- The DRNC shall include the *Cell Capability Container FDD IE*, the *Cell Capability Container TDD IE* and/or the *Cell Capability Container TDD LCR IE* if the DRNC is aware that the neighbouring cell supports any functionality listed in 9.2.2.D, 9.2.3.1a and 9.2.3.1b.
- For the UMTS neighbouring cells which are controlled by the DRNC, the DRNC shall report in the RADIO LINK SETUP RESPONSE message the restriction state of those cells, otherwise the *Restriction StateIndicator IE* may be absent. The DRNC shall include in the RADIO LINK SETUP RESPONSE message the *Restriction StateIndicator IE* for the neighbouring cells which are controlled by the DRNC in the *Neighbouring FDD Cell Information IE*, the *Neighbouring TDD Cell Information IE* and the *Neighbouring TDD Cell Information LCR IE*.
- If available, the DRNC shall include the *SNA Information IE* for the concerned neighbouring cells in the *Neighbouring FDD Cell Information IE*, the *Neighbouring TDD Cell Information IE* and the *Neighbouring TDD Cell Information LCR IE*.

If there are GSM neighbouring cells to the cell(s) where a radio link is established, the DRNC shall include in the RADIO LINK SETUP RESPONSE message the *Neighbouring GSM Cell Information IE* for each of the GSM neighbouring cells. If available the DRNC shall include in the RADIO LINK SETUP RESPONSE message the *Cell Individual Offset IE*, and if the *Cell Individual Offset IE* alone cannot represent the value of the offset, the DRNC shall also include the *Extended GSM Cell Individual Offset IE* in the *Neighbouring GSM Cell Information IE*. If available the DRNC shall also include in the RADIO LINK SETUP RESPONSE message the *Coverage Indicator IE*, *Antenna Co-location Indicator IE* and *HCS Prio IE* in the *Neighbouring GSM Cell Information IE*. If available, the DRNC shall also include the *SNA Information IE* for the concerned neighbouring cells in the *Neighbouring GSM Cell Information IE*.

When receiving the *SNA Information* IE in the RADIO LINK SETUP RESPONSE message, the SRNC should use it to restrict cell access based on SNA information. See also [40] for a broader description of the SNA access control.

If there are GERAN neighbouring cells to the cell(s) where a radio link is established, the DRNC shall include the *GERAN Cell Capability* IE in the *Neighbouring GSM Cell Information* IE that is included in the RADIO LINK SETUP RESPONSE message for each of the GERAN cells.

If there are GERAN Iu-mode neighbouring cells to the cell(s) where a radio link is established, the DRNC shall include, if available, the *GERAN Classmark* IE in the *Neighbouring GSM Cell Information* IE that is included in the RADIO LINK SETUP RESPONSE message for each of the GERAN Iu-mode neighbouring cells. Ref. [39] defines when the transmission of the *GERAN Classmark* IE will be required at the initiation of the Relocation Preparation procedure.

**[1.28Mcps TDD - Uplink Synchronisation Parameters LCR]:**

[If the *Uplink Synchronisation Parameters LCR* IE is present, the DRNC shall use the indicated values of *Uplink synchronisation stepsize* IE and *Uplink synchronisation frequency* IE when evaluating the timing of the UL synchronisation.]

**[1.28Mcps TDD - Uplink Timing Advance Control LCR]:**

[1.28Mcps TDD - The DRNC shall include the *Uplink Timing Advance Control LCR* IE in the RADIO LINK SETUP RESPONSE message.]

**MBMS Handling:**

If the *MBMS Bearer Service List* IE is included in the RADIO LINK SETUP REQUEST message, the DRNC shall perform the UE Linking as specified in [50], section 5.1.6.

**General:**

If the RADIO LINK SETUP REQUEST message includes the *RL Specific DCH Information* IE, the DRNC may use the transport layer address and the binding identifier received from the SRNC when establishing a transport bearer for the DCH or the set of co-ordinated DCHs.

[FDD - If the RADIO LINK SETUP REQUEST message includes the *SSDT Cell Identity* IE and the *S-Field Length* IE, the DRNS shall activate SSDT, if supported, using the *SSDT Cell Identity* IE, *S-Field Length* IE and *SSDT Cell Identity Length* IE.]

[FDD - If the RADIO LINK SETUP REQUEST message includes the *Qth Parameter* IE in addition to the *SSDT Cell Identity* IE, the DRNS shall use the *Qth Parameter* IE, if Qth signalling is supported, when SSDT is activated in the concerned new RL.]

[FDD - If the RADIO LINK SETUP REQUEST message includes the *SSDT Cell Identity for EDSCHPC* IE, the DRNS shall activate enhanced DSCH power control, if supported, using the *SSDT Cell Identity for EDSCHPC* IE and *SSDT Cell Identity Length* IE as well as *Enhanced DSCH PC* IE in accordance with ref. [10] subclause 5.2.2. If the RADIO LINK SETUP REQUEST message includes both *SSDT Cell Identity* IE and *SSDT Cell Identity for EDSCHPC* IE, then the DRNS shall ignore the *SSDT Cell Identity for EDSCHPC* IE. If the enhanced DSCH power control is activated and the *TFCI PC Support Indicator* IE is set to "TFCI PC Mode 2 Supported", the primary/secondary status determination in the enhanced DSCH power control shall be applied to the TFCI power control in DSCH hard split mode.]

[FDD - If the *DRAC Control* IE is set to "requested" in the RADIO LINK SETUP REQUEST message for at least one DCH and if the DRNS supports the DRAC, the DRNC shall include in the RADIO LINK SETUP RESPONSE message the *Secondary CCPCH Info* IE for the FACH in which the DRAC information is sent, for each Radio Link established in a cell where DRAC is active. If the DRNS does not support DRAC, the DRNC shall not provide these IEs in the RADIO LINK SETUP RESPONSE message.]

If no *D-RNTI* IE was included in the RADIO LINK SETUP REQUEST message, the DRNC shall include in the RADIO LINK SETUP RESPONSE message the *D-RNTI* IE, the *CN PS Domain Identifier* IE and/or the *CN CS Domain Identifier* IE for the CN domains (using LAC and RAC of the current cell) to which the DRNC is connected.

[FDD - If the *D-RNTI* IE was included in the RADIO LINK SETUP REQUEST message the DRNC shall include in the RADIO LINK SETUP RESPONSE message the *Primary Scrambling Code* IE, the *UL UARFCN* IE and the *DL UARFCN* IE.]

[TDD - If the *D-RNTI* IE was included in the RADIO LINK SETUP REQUEST message the DRNC shall include in the RADIO LINK SETUP RESPONSE message the *UARFCN* IE, the *Cell Parameter ID* IE and the *SCTD Indicator* IE.]

[3.84Mcps TDD - If the *D-RNTI* IE was included in the RADIO LINK SETUP REQUEST message the DRNC shall include in the RADIO LINK SETUP RESPONSE message the *Sync Case* IE and if the *Sync Case* IE is set to "Case 2", the DRNC shall also include the *SCH Time Slot* IE in the RADIO LINK SETUP RESPONSE message. If the included *Sync Case* IE is set to "Case1", the DRNC shall also include the *Time Slot For SCH* IE.]

[3.84Mcps TDD - The DRNC shall include the *Secondary CCPCH Info TDD* IE in the RADIO LINK SETUP RESPONSE message if at least one *DSCH Information Response* IE or *USCH Information Response* IE is included in the message and at least one DCH is configured for the radio link. The DRNC shall also include the *Secondary CCPCH Info TDD* IE in the RADIO LINK SETUP RESPONSE message if at least one *DSCH Information Response* IE or *USCH Information Response* IE is included in the message and the SHCCH messages for this radio link will be transmitted over a different secondary CCPCH than selected by the UE from system information.]

[1.28 Mcps TDD - The DRNC shall include the *Secondary CCPCH Info TDD LCR* IE in the RADIO LINK SETUP RESPONSE message if at least one *DSCH Information Response LCR* IE or *USCH Information Response LCR* IE is included in the message and at least one DCH is configured for the radio link. The DRNC shall also include the *Secondary CCPCH Info TDD LCR* IE in the RADIO LINK SETUP RESPONSE message if at least one *DSCH Information Response LCR* IE or *USCH Information Response LCR* IE is included in the message and the SHCCH messages for this radio link will be transmitted over a different secondary CCPCH than selected by the UE from system information.]

For each Radio Link established in a cell in which at least one URA Identity is being broadcast, the DRNC shall include in the *URA Information* IE within the RADIO LINK SETUP RESPONSE message URA Information for this cell including the *URA ID* IE, the *Multiple URAs Indicator* IE indicating whether or not multiple URA Identities are being broadcast in the cell, and the *RNC-ID* IEs of all other RNCs that have at least one cell within the URA identified by the *URA ID* IE.

Depending on local configuration in the DRNS, the DRNC may include in the RADIO LINK SETUP RESPONSE message the *UTRAN Access Point Position* IE and the geographical co-ordinates of the cell, represented either by the *Cell GAI* IE or by the *Cell GA Additional Shapes* IE. If the DRNC includes the *Cell GA Additional Shapes* IE in the RADIO LINK SETUP RESPONSE message, it shall also include the *Cell GAI* IE.

If the DRNS need to limit the user rate in the uplink of a DCH due to congestion caused by the UL UTRAN Dynamic Resources (see subclause 9.2.1.79) when starting to utilise a new Radio Link, the DRNC shall include in the RADIO LINK SETUP RESPONSE message the *Allowed UL Rate* IE in the *DCH Information Response* IE for this Radio Link.

If the DRNS need to limit the user rate in the downlink of a DCH due to congestion caused by the DL UTRAN Dynamic Resources (see subclause 9.2.1.79) when starting to utilise a new Radio Link, the DRNC shall include in the RADIO LINK SETUP RESPONSE message the *Allowed DL Rate* IE in the *DCH Information Response* IE for this Radio Link.

If the *Permanent NAS UE Identity* IE is included in the RADIO LINK SETUP REQUEST message, the DRNS shall store the information for the considered UE Context for the life-time of the UE Context.

If the RADIO LINK SETUP REQUEST message includes the *Permanent NAS UE Identity* IE and a *C-ID* IE corresponding to a cell reserved for operator use, the DRNS shall use this information to determine whether it can set up a Radio Link on this cell or not for the considered UE Context.

If the HCS priority information is available in the DRNS, it shall include the *HCS Prio* IE for each of the established RLs in the RADIO LINK SETUP RESPONSE message.

[FDD - If the accessed cell supports TFCI power control, the DRNC shall include the *TFCI PC Support Indicator* IE in the RADIO LINK SETUP RESPONSE message.]

The DRNS shall start receiving on the new RL(s) after the RLs are successfully established.

[FDD - If the RADIO LINK SETUP REQUEST message includes the *Cell Portion ID* IE, the DRNS shall use this information when it decides to use beamforming for the new RL.]

**[FDD - Radio Link Set Handling]:**

[FDD - The *First RLS Indicator* IE indicates if the concerned RL shall be considered part of the first RLS established towards this UE. The DRNS shall use the *First RLS Indicator* IE to determine the initial TPC pattern in the DL of the concerned RL and all RLs which are part of the same RLS, as described in [10], section 5.1.2.2.1.2.

[FDD - For each RL not having a common generation of the TPC commands in the DL with another RL, the DRNS shall assign to the RL a unique value for the *RL Set ID* IE which uniquely identifies the RL as an RL Set within the UE Context.]

[FDD - For all RLs having a common generation of the TPC commands in the DL with another RL, the DRNS shall assign to each RL the same value for the *RL Set ID* IE which uniquely identifies these RLs as members of the same RL Set within the UE Context.]

[FDD -The UL out-of-sync algorithm defined in ref. [10] shall, for each of the established RL Set(s), use the maximum value of the parameters N\_OUTSYNC\_IND and T\_RLFAILURE that are configured in the cells supporting the radio links of the RL Set. The UL in-sync algorithm defined in [10] shall, for each of the established RL Set(s), use the minimum value of the parameters N\_INSYNC\_IND that are configured in the cells supporting the radio links of the RL Set.]

[FDD - For all RLs having a common generation of E-RGCH and E-HICH related information with another RL, the DRNS shall assign to each RL the same value for the *E-DCH RL Set ID* IE which uniquely identifies these RLs as members of the same E-DCH RL Set within the UE Context.]

**Response Message:**

Upon receipt of the RADIO LINK SETUP REQUEST message, the DRNS allocates the requested type of channelisation codes and other physical channel resources for each RL and assigns a binding identifier and a transport layer address for each DCH, for each set of co-ordinated DCHs and for each DSCH [TDD - and USCH]. This information shall be sent to the SRNC in the RADIO LINK SETUP RESPONSE message when all the RLs have been successfully established.

After sending the RADIO LINK SETUP RESPONSE message the DRNS shall continuously attempt to obtain UL synchronisation on the Uu interface and start reception on the new RL.

For each RL for which the *Delayed Activation* IE is not included in the RADIO LINK SETUP REQUEST message the DRNS shall:

- [FDD - start transmission on the DL DPDCH(s) of the new RL as specified in ref. [4].]
- [TDD - start transmission on the new RL immediately as specified in ref. [4].]

For each RL for which the *Delayed Activation* IE is included in the RADIO LINK SETUP REQUEST message, the DRNS shall:

- if the *Delayed Activation* IE indicates "Separate Indication":
  - not start any DL transmission for the concerned RL on the Uu interface;
- if the *Delayed Activation* IE indicates "CFN":
  - [FDD - start transmission on the DL DPDCH(s) of the new RL as specified in ref. [4], however never before the CFN indicated in the *Activation CFN* IE.]
  - [TDD - start transmission on the new RL at the CFN indicated in the *Activation CFN* IE as specified in ref. [4].]

### 8.3.1.3 Unsuccessful Operation

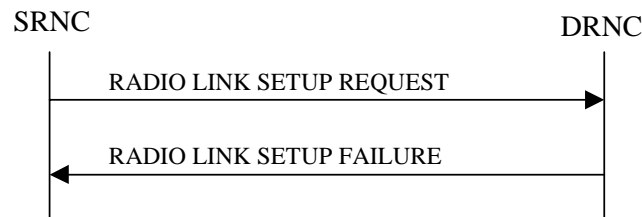

**Figure 6: Radio Link Setup procedure: Unsuccessful Operation**

If the establishment of at least one radio link is unsuccessful, the DRNC shall respond with a RADIO LINK SETUP FAILURE message. The DRNC shall include in the RADIO LINK SETUP FAILURE message a general *Cause* IE or a *Cause* IE for each failed radio link. The *Cause* IE indicates the reason for failure.

[FDD - If some radio links were established successfully, the DRNC shall indicate this in the RADIO LINK SETUP FAILURE message in the same way as in the RADIO LINK SETUP RESPONSE message.]

[FDD - If the RL identified by the *PDSCH RL ID* IE is a radio link in the DRNS and this RL is successfully established, then the DRNC shall allocate a DSCH-RNTI to the UE Context and include the *DSCH-RNTI* IE in the RADIO LINK SETUP FAILURE message.]

If the RADIO LINK SETUP REQUEST message includes a *C-ID* IE corresponding to a cell reserved for operator use and the *Permanent NAS UE Identity* IE is not present, the DRNC shall reject the procedure and send the RADIO LINK SETUP FAILURE message.

[FDD - If the accessed cell supports TFCI power control, the DRNC shall include the *TFCI PC Support Indicator* IE in the RADIO LINK SETUP FAILURE message.]

[FDD - If the RL identified by the *HS-PDSCH RL ID* IE is a radio link in the DRNS and this RL is successfully established, then the DRNC shall allocate a HS-DSCH-RNTI to the UE Context and include the *HS-DSCH-RNTI* IE and the *HS-DSCH FDD Information Response* IE in the RADIO LINK SETUP FAILURE message.]

Typical cause values are:

#### Radio Network Layer Causes:

- [FDD - UL Scrambling Code Already in Use];
- DL Radio Resources not Available;
- UL Radio Resources not Available;
- [FDD - Combining Resources not available];
- Combining not Supported
- Requested Configuration not Supported;
- Cell not Available;
- [FDD - Requested Tx Diversity Mode not Supported];
- Power Level not Supported;
- Number of DL codes not supported;
- Number of UL codes not supported;
- Dedicated Transport Channel Type not Supported;
- DL Shared Channel Type not Supported;
- [TDD - UL Shared Channel Type not Supported];



- [FDD - UL Spreading Factor not Supported];
- [FDD - DL Spreading Factor not Supported];
- CM not Supported;
- [FDD - DPC mode change not Supported];
- Cell reserved for operator use;
- Delayed Activation not supported;
- [FDD - HARQ Preamble Mode not supported].

- F-DPCH not supported.

#### Transport Layer Causes:

- Transport Resource Unavailable.

#### Miscellaneous Causes:

- Control Processing Overload;
- HW Failure;
- Not enough User Plane Processing Resources.

### 8.3.1.4 Abnormal Conditions

If the DRNC receives either an S-RNTI or a D-RNTI which already has RL(s) established the DRNC shall send the RADIO LINK SETUP FAILURE message to the SRNC, indicating the reason for failure.

[FDD - If the RADIO LINK SETUP REQUEST message includes the *Active Pattern Sequence Information* IE, but the *Transmission Gap Pattern Sequence Information* IE is not present, then the DRNC shall reject the procedure using the RADIO LINK SETUP FAILURE message.]

[FDD - If the RADIO LINK SETUP REQUEST message includes both the *Initial DL TX Power* IE and the *Primary CPICH Ec/No* IE or does not include either of these IEs, then the DRNC shall reject the procedure using the RADIO LINK SETUP FAILURE message.]

If more than one DCH of a set of co-ordinated DCHs has the *QE-Selector* IE set to "selected" [TDD - or no DCH of a set of co-ordinated DCHs has the *QE-Selector* IE set to "selected"] the DRNC shall reject the Radio Link Setup procedure and shall respond with a RADIO LINK SETUP FAILURE message.

[FDD - If only the *Initial DL TX Power* IE or the *Uplink SIR Target* IE is included in the RADIO LINK SETUP REQUEST message, then DRNC shall reject the Radio Link Setup procedure and shall respond with the RADIO LINK SETUP FAILURE message.]

If the RADIO LINK SETUP REQUEST message includes a *DCH Information* IE with multiple *DCH Specific Info* IEs, and if the DCHs in the *DCH Information* IE do not have the same *Transmission Time Interval* IE in the *Semi-static Transport Format Information* IE, then the DRNC shall reject the procedure using the RADIO LINK SETUP FAILURE message.

[FDD - If the RADIO LINK SETUP REQUEST message includes the *Enhanced Primary CPICH Ec/No* IE, but not the *Primary CPICH Ec/No* IE, then the DRNC shall reject the procedure using the RADIO LINK SETUP FAILURE message.]

[FDD - If the RADIO LINK SETUP REQUEST message does not include the *Split Type* IE but includes *TFCI Signalling Mode* IE set to "Split", then the DRNC shall reject the procedure using the RADIO LINK SETUP FAILURE message.]

[FDD - If the RADIO LINK SETUP REQUEST message does not include the *Length of TFCI2* IE but the *Split type* IE is set to "Logical", then the DRNC shall reject the procedure using the RADIO LINK SETUP FAILURE message.]

[FDD - If the RADIO LINK SETUP REQUEST message includes the *Split Type* IE set to the value "Hard" and the *Length Of TFCI2* IE set to the value "1", "2", "5", "8", "9" or "10", then the DRNC shall reject the procedure using the RADIO LINK SETUP FAILURE message.]

[FDD - If the RADIO LINK SETUP REQUEST message does not include the *Split Type* IE but includes the *Length of TFCI2* IE, then the DRNC shall reject the procedure using the RADIO LINK SETUP FAILURE message.]

If the RADIO LINK SETUP REQUEST message includes the *Transport Layer Address* IE and the *Binding ID* IE in the *RL Specific DCH Information* IE included in the *RL Information* IE for a specific RL and the *Diversity Control Field* IE is set to "Must", the DRNC shall reject the Radio Link Setup procedure and the DRNC shall respond with the RADIO LINK SETUP FAILURE message.

If the RADIO LINK SETUP REQUEST message includes the *Transport Layer Address* IE or the *Binding ID* IE, and not both are present for a transport bearer intended to be established, the DRNC shall reject the Radio Link Setup procedure and the DRNC shall respond with the RADIO LINK SETUP FAILURE message.

If the RADIO LINK SETUP REQUEST message includes an *HS-PDSCH RL-ID* IE not referring to one of the radio links to be established, the DRNC shall reject the procedure using the RADIO LINK SETUP FAILURE message.

If the RADIO LINK SETUP REQUEST message contains the *HS-DSCH Information* IE and if the Priority Queues associated with the same *HS-DSCH MAC-d Flow ID* IE have the same *Scheduling Priority Indicator* IE value, the DRNC shall reject the procedure using the RADIO LINK SETUP FAILURE message.

[FDD - If the RADIO LINK SETUP REQUEST message includes the *F-DPCH Information IE* and the *DL DPCH Information IE*, then the DRNS shall reject the procedure using the RADIO LINK SETUP FAILURE message.]

## 8.3.2 Radio Link Addition

### 8.3.2.1 General

This procedure is used for establishing the necessary resources in the DRNS for one or more additional RLs towards a UE when there is already at least one RL established to the concerned UE via this DRNS.

This procedure shall use the signalling bearer connection for the relevant UE Context.

The Radio Link Addition procedure shall not be initiated if a Prepared Reconfiguration exists, as defined in subclause 3.1.

[FDD - The Radio Link Addition procedure serves to establish one or more new Radio Links which do not contain the DSCH. If the DSCH shall be moved into a new Radio Link, the Radio Link reconfiguration procedure shall be applied.]

[TDD - The Radio Link Addition procedure serves to establish a new Radio Link with the DSCH and USCH included, if they existed before.]

### 8.3.2.2 Successful Operation

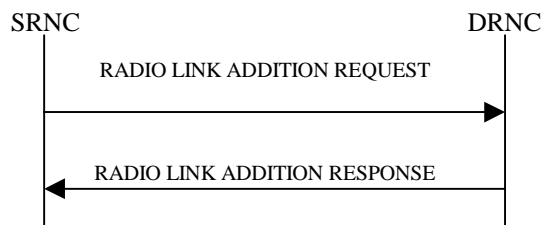

**Figure 7: Radio Link Addition procedure: Successful Operation**

The procedure is initiated with a RADIO LINK ADDITION REQUEST message sent from the SRNC to the DRNC.

Upon receipt, the DRNS shall reserve the necessary resources and configure the new RL(s) according to the parameters given in the message. Unless specified below, the meaning of parameters is specified in other specifications.

The DRNS shall prioritise resource allocation for the RL(s) to be established according to Annex A.

#### Transport Channel Handling:

[3.84 Mcps TDD - The DRNC shall include the *UL/DL DPCH Information* IE within the *UL/DL CCTrCH Information* IE for each CCTrCH that requires DPCHs.]

[1.28 Mcps TDD - The DRNC shall include the *UL/DL DPCH Information LCR* IE within the *UL/DL CCTrCH Information LCR* IE for each CCTrCH that requires DPCHs.]

#### DSCH:

[3.84 Mcps TDD - If the radio link to be added includes a DSCH, the DRNC shall include in the RADIO LINK ADDITION RESPONSE message a *DSCH Information Response* IE for each DSCH.]

[1.28 Mcps TDD - If the radio link to be added includes a DSCH, the DRNC shall include in the RADIO LINK ADDITION RESPONSE message a *DSCH Information Response LCR* IE for each DSCH.]

#### [TDD - USCH:]

[3.84 Mcps TDD - If the radio link to be added includes any USCHs, the DRNC shall include in the RADIO LINK ADDITION RESPONSE message a *USCH Information Response* IE for each USCH.]

[1.28 Mcps TDD - If the radio link to be added includes any USCHs, the DRNC shall include in the RADIO LINK ADDITION RESPONSE message a *USCH Information Response LCR* IE for each USCH.]

#### Physical Channels Handling:

##### [FDD -Compressed Mode]:

[FDD - If the RADIO LINK ADDITION REQUEST message includes the *Active Pattern Sequence Information* IE, the DRNS shall use the information to activate the indicated (all ongoing) Transmission Gap Pattern Sequence(s) in the new RL. The received *CM Configuration Change CFN* IE refers to the latest passed CFN with that value. The DRNS shall treat the received *TGCFN* IEs as follows:]

- [FDD - If any received *TGCFN* IE has the same value as the received *CM Configuration Change CFN* IE, the DRNS shall consider the concerned Transmission Gap Pattern Sequence as activated at that CFN.]
- [FDD - If any received *TGCFN* IE does not have the same value as the received *CM Configuration Change CFN* IE but the first CFN after the *CM Configuration Change CFN* with a value equal to the *TGCFN* IE has already passed, the DRNS shall consider the concerned Transmission Gap Pattern Sequence as activated at that CFN.]
- [FDD - For all other Transmission Gap Pattern Sequences included in the *Active Pattern Sequence Information* IE, the DRNS shall activate each Transmission Gap Pattern Sequence at the first CFN after the *CM Configuration Change CFN* with a value equal to the *TGCFN* IE for the Transmission Gap Pattern Sequence.]

[FDD - If the RADIO LINK ADDITION REQUEST message includes the *Active Pattern Sequence Information* IE and the concerned UE Context is configured to use F-DPCH in the downlink, the DRNS shall ignore, when activating the Transmission Gap Pattern Sequence(s), the downlink compressed mode method information, if existing, for the concerned Transmission Gap Pattern Sequence(s) in the Compressed Mode Configuration.]

[FDD - If the *Active Pattern Sequence Information* IE is not included, the DRNS shall not activate the ongoing compressed mode pattern in the new RLs, but the ongoing pattern in the existing RL shall be maintained.]

[FDD - If some Transmission Gap Pattern sequences using SF/2 method are initialised in the DRNS and the UE Context is configured to use DPCH in the downlink, the DRNC shall include the *Transmission Gap Pattern Sequence Scrambling Code Information* IE in the *DL Code Information* IE in the RADIO LINK ADDITION RESPONSE message to indicate the Scrambling code change method that it selects for each channelisation code.]

#### [FDD - DL Code Information]:

[FDD - When more than one DL DPDCH are assigned per RL, the segmented physical channel shall be mapped on to DL DPDCHs according to [8]. When  $p$  number of DL DPDCHs are assigned to each RL, the first pair of DL Scrambling Code and FDD DL Channelisation Code Number corresponds to "*PhCH number 1*", the second to "*PhCH number 2*", and so on until the  $p$ th to "*PhCH number p*".]

#### [TDD - CCTrCH Handling]:

[TDD - If the *UL CCTrCH Information* IE is present, the DRNS shall configure the new UL CCTrCH(s) according to the parameters given in the message.]

[1.28Mcps TDD - If the *UL CCTrCH Information* IE includes the *TDD TPC Uplink Step Size* IE, the DRNS shall configure the uplink TPC step size according to the parameters given in the message, otherwise it shall use the step size configured in other radio link.]

[TDD - If the *DL CCTrCH Information* IE is present, the DRNS shall configure the new DL CCTrCH(s) according to the parameters given in the message.]

[TDD - If the *DL CCTrCH Information* IE includes the *TDD TPC Downlink Step Size* IE, the DRNS shall configure the downlink TPC step size according to the parameters given in the message, otherwise it shall use the step size configured in other radio link.]

#### [FDD – Phase Reference Handling]:

[FDD – If Primary CPICH is not to be used as a Phase Reference for this Radio Link, the DRNC shall include the *Primary CPICH Usage For Channel Estimation* IE set to the value "Primary CPICH shall not be used" in the RADIO LINK ADDITION RESPONSE message.]

#### General:

[FDD - The DRNS shall use the provided Uplink SIR Target value as the current target for the inner-loop power control.]

### Radio Link Handling:

#### Diversity Combination Control:

The *Diversity Control Field* IE indicates for each RL whether the DRNS shall combine the new RL with existing RL(s) or not on the Iur.

- If the *Diversity Control Field* IE is set to "May" (be combined with another RL), the DRNS shall decide for any of the alternatives.
- If the *Diversity Control Field* IE is set to "Must", the DRNS shall combine the RL with one of the other RL. When a new RL is to be combined the DRNS shall choose which RL(s) to combine it with.
- If the *Diversity Control Field* IE is set to "Must not", the DRNS shall not combine the RL with any other existing RL.

[FDD - The *Diversity Control Field* IE is only applicable for DCHs, in case of E-DCH it shall always be assumed to be set to "May".]

In the case of not combining a RL with a RL established with a previous Radio Link Setup or Radio Link Addition Procedure or a RL previously listed in the RADIO LINK ADDITION RESPONSE message, the DRNC shall indicate with the Diversity Indication in the *RL Information Response* IE in the RADIO LINK ADDITION RESPONSE message that no combining is done. In this case the DRNC shall include in the *DCH Information Response* IE both the *Transport Layer Address* IE and the *Binding ID* IE for the transport bearer to be established for each DCH of the RL in the RADIO LINK ADDITION RESPONSE message.

[FDD - In case of combining E-DCH, the E-DCH FDD Information Response IE shall be included in the RADIO LINK ADDITION RESPONSE message containing the *Binding ID* IE and the *Transport Layer Address* IE for the establishment of transport bearers for every E-DCH MAC-d flow being established.]

In the case of combining with a RL established with a previous Radio Link Setup or Radio Link Addition Procedure or with a RL previously listed in this RADIO LINK ADDITION RESPONSE message, the DRNC shall indicate with the Diversity Indication in the *RL Information Response* IE in the RADIO LINK ADDITION RESPONSE message that the RL is combined. In this case, the *RL ID* IE indicates (one of) the previously established RL(s) or a RL previously listed in this RADIO LINK ADDITION RESPONSE message with which the new RL is combined.

[TDD - The DRNC shall always include in the RADIO LINK ADDITION RESPONSE message both the *Transport Layer Address* IE and the *Binding ID* IE for the transport bearer to be established for each DSCH and USCH of the RL.]

In the case of a set of co-ordinated DCHs, the DRNC shall include in the RADIO LINK ADDITION RESPONSE message the *Binding ID* IE and the *Transport Layer Address* IE for only one of the DCHs in the set of co-ordinated DCHs.

If the DRNS needs to limit the user rate in the uplink of a DCH due to congestion caused by the UL UTRAN Dynamic Resources (see subclause 9.2.1.79) when starting to utilise a new Radio Link, the DRNC shall include in the RADIO LINK ADDITION RESPONSE message the *Allowed UL Rate* IE in the *DCH Information Response* IE for this Radio Link.

If the DRNS needs to limit the user rate in the downlink of a DCH due to congestion caused by the DL UTRAN Dynamic Resources (see subclause 9.2.1.79) when starting to utilise a new Radio Link, the DRNC shall include in the RADIO LINK ADDITION RESPONSE message the *Allowed DL Rate* IE in the *DCH Information Response* IE for this Radio Link.

#### [FDD - Transmit Diversity]:

The DRNS shall activate any feedback mode diversity according to the received settings.

[FDD - If the cell in which the RL is being added is capable to provide Close loop Tx diversity, the DRNC shall indicate the Closed loop timing adjustment mode of the cell by including the *Closed Loop Timing Adjustment Mode* IE in the RADIO LINK ADDITION RESPONSE message.]

[FDD - When the *Transmit Diversity Indicator* IE is present the DRNS shall activate/deactivate the Transmit Diversity for each new Radio Link in accordance with the *Transmit Diversity Indicator* IE using the diversity mode of the existing Radio Link(s).]

#### **DL Power Control:**

[FDD - If the *Primary CPICH Ec/No* IE or the *Primary CPICH Ec/No* IE and the *Enhanced Primary CPICH Ec/No* IE measured by the UE are included for an RL in the RADIO LINK ADDITION REQUEST message, the DRNS shall use this in the calculation of the Initial DL TX Power for this RL. If the *Primary CPICH Ec/No* IE is not present, the DRNS shall set the Initial DL TX Power based on the power relative to the Primary CPICH power used by the existing RLs.]

[TDD - If [3.84Mcps TDD - the *DL Time Slot ISCP Info* IE] [1.28Mcps TDD - the *DL Time Slot ISCP Info LCR* IE] is included in the RADIO LINK ADDITION REQUEST message, the DRNS shall use it in the calculation of the Initial DL TX Power.]

[TDD - If the *Primary CCPCH RSCP Delta* IE is included, the DRNS shall assume that the reported value for Primary CCPCH RSCP is in the negative range as per [24], and the value is equal to the *Primary CCPCH RSCP Delta* IE. If the *Primary CCPCH RSCP Delta* IE is not included and the *Primary CCPCH RSCP* IE is included, the DRNS shall assume that the reported value is in the non-negative range as per [24], and the value is equal to the *Primary CCPCH RSCP* IE. The DRNS shall use it in the calculation of the Initial DL TX Power.]

[TDD - If the *Primary CCPCH RSCP* IE, *Primary CCPCH RSCP Delta* IE, [3.84Mcps TDD - and the *DL Time Slot ISCP Info* IE] [1.28Mcps TDD - and the *DL Time Slot ISCP Info LCR* IE] are not present, the DRNS shall set the Initial DL TX Power based on the power relative to the Primary CCPCH power used by the existing RL.]

[FDD - The Initial DL TX Power shall be applied until UL synchronisation is achieved on the Uu interface for that RLS or Power Balancing is activated. No inner loop power control or power balancing shall be performed during this period. The DL power shall then vary according to the inner loop power control (see ref. [10] subclause 5.2.1.2) and the power control procedure (see 8.3.7).]

[TDD - The Initial DL TX Power shall be applied until UL synchronisation is achieved on the Uu interface for that RL. No inner loop power control shall be performed during this period. The DL power shall then vary according to the inner loop power control (see ref. [22] subclause 4.2.3.3).]

[3.84 Mcps TDD - The DL TX power upper and lower limit is configured in the following way: The DRNC shall include the *Maximum DL TX Power* IE and *Minimum DL TX Power* IE in the RADIO LINK ADDITION RESPONSE message. If the maximum or minimum power needs to be different for particular DCH type CCTrCHs, the DRNC shall include the value(s) for that CCTrCH in the *CCTrCH Maximum DL TX Power* IE and *CCTrCH Minimum DL TX Power*. The DRNS shall not transmit with a higher power than indicated by the appropriate *Maximum DL TX Power* IE/*CCTrCH Maximum DL TX Power* IE or lower than indicated by the appropriate *Minimum DL TX Power* IE/*CCTrCH Minimum DL TX Power* IE on any DL DPCH within each CCTrCH of the RL.]

[1.28 Mcps TDD - The DL TX power upper and lower limit is configured in the following way: The DRNC shall include the *Maximum DL TX Power* IE and *Minimum DL TX Power* IE in the RADIO LINK ADDITION RESPONSE message. If the maximum or minimum power needs to be different for particular timeslots within a DCH type CCTrCH, the DRNC shall include the value(s) for that timeslot in the *Maximum DL TX Power* IE and *Minimum DL TX Power* within the *DL Timeslot Information LCR* IE. The DRNS shall not transmit with a higher power than indicated by the appropriate *Maximum DL TX Power* IE or lower than indicated by the appropriate *Minimum DL TX Power* IE on any DL DPCH within each timeslot of the RL.]

[FDD - If the *DPC Mode* IE is present in the RADIO LINK ADDITION REQUEST message, the DRNC shall apply the DPC mode indicated in the message, and be prepared that the DPC mode may be changed during the lifetime of the RL. If the *DPC Mode* IE is not present in the RADIO LINK ADDITION REQUEST message, DPC mode 0 shall be applied (see ref. [10]).]

The DRNC shall provide the configured *Maximum DL TX Power* IE and *Minimum DL TX Power* IE for every new RL to the SRNC in the RADIO LINK ADDITION RESPONSE message. The DRNS shall not transmit with a ~~higher~~ power higher than indicated by the *Maximum DL TX Power* IE or lower than indicated by the *Minimum DL TX Power* IE on any DL DPCH [FDD - or on the F-DPCH] of the RL [FDD - except, if the UE Context is configured to use DPCH in the downlink, during compressed mode, when the  $\delta P_{curr}$  as

described in ref.[10] subclause 5.2.1.3, shall be added to the maximum DL power for the associated compressed frame.]

[FDD - If the power balancing is active with the Power Balancing Adjustment Type of the UE Context set to "Individual" in the existing RL(s) and the RADIO LINK ADDITION REQUEST message includes the *DL Reference Power* IE, the DRNS shall activate the power balancing and use the *DL Reference Power* IE for the power balancing procedure in the new RL(s), if activation of power balancing by the RADIO LINK ADDITION REQUEST message is supported by the DRNS, according to subclause 8.3.15. In this case, the DRNC shall include the *DL Power Balancing Activation Indicator* IE in the *RL Information Response* IE in the RADIO LINK ADDITION RESPONSE message. If the DRNS starts the DL transmission and the activation of the power balancing at the same CFN, the initial power of the power balancing, i.e.  $P_{init}$  shall be set to the power level which is calculated based on the *Primary CPICH Ec/No* IE or the *Enhanced Primary CPICH Ec/No* IE (if received), or to the power level which is calculated based on the power relative to the Primary CPICH power used by the existing RLs.]

#### **UL Power Control:**

The DRNC shall also provide the configured UL Maximum SIR and UL Minimum SIR for every new RL to the SRNC in the RADIO LINK ADDITION RESPONSE message. These values are taken into consideration by DRNS admission control and shall be used by the SRNC as limits for the UL inner-loop power control target.

#### **Neighbouring Cell Handling:**

If there are UMTS neighbouring cell(s) to the cell in which a Radio Link was established then:

- The DRNC shall include in the RADIO LINK ADDITION RESPONSE message the *Neighbouring FDD Cell Information* IE and/or *Neighbouring TDD Cell Information* IE in the *Neighbouring UMTS Cell Information* IE for each neighbouring FDD cell and/or TDD cell respectively. In addition, if the information is available, the DRNC shall include in the RADIO LINK ADDITION RESPONSE message the *Frame Offset* IE, *Primary CPICH Power* IE, *Cell Individual Offset* IE, *STTD Support Indicator* IE, *Closed Loop Mode1 Support Indicator* IE, *Closed Loop Mode2 Support Indicator* IE, *Coverage Indicator* IE, *Antenna Co-location Indicator* IE and *HCS Prio* IE in the *Neighbouring FDD Cell Information* IE, and the *Frame Offset* IE, *Cell Individual Offset* IE, *DPCH Constant Value* IE and the *PCCPCH Power* IE, *Coverage Indicator* IE, *Antenna Co-location Indicator* IE and *HCS Prio* IE in the *Neighbouring TDD Cell Information* IE or the *Neighbouring TDD Cell Information LCR* IE. If the *Neighbouring TDD Cell Information* IE includes the *Sync Case* IE set to "Case1", the DRNC shall include the *Time SlotFor SCH* IE in the *Neighbouring TDD Cell Information* IE. If the *Neighbouring TDD Cell Information* IE includes the *Sync Case* IE set to "Case2", the DRNC shall include the *SCH Time Slot* IE in the *Neighbouring TDD Cell Information* IE.
- If a UMTS neighbouring cell is not controlled by the same DRNC, the DRNC shall also include in the RADIO LINK ADDITION RESPONSE message the *CN PS Domain Identifier* IE and/or *CN CS Domain Identifier* IE which are the identifiers of the CN nodes connected to the RNC controlling the UMTS neighbouring cell.
- [FDD - The DRNC shall include in the RADIO LINK ADDITION RESPONSE message the *DPC Mode Change Support Indicator* IE for each neighbour cell in the *Neighbouring FDD Cell Information* IE if this information is available.]
- The DRNC shall include the *Cell Capability Container FDD* IE, the *Cell Capability Container TDD* IE and/or the *Cell Capability Container TDD LCR* IE if the DRNC is aware that the neighbouring cell supports any functionality listed in 9.2.2.D, 9.2.3.1a and 9.2.3.1b.
- For the UMTS neighbouring cells which are controlled by the DRNC, the DRNC shall report in the RADIO LINK SETUP RESPONSE message the restriction state of those cells, otherwise *Restriction State Indicator* IE may be absent. The DRNC shall include the *Restriction State Indicator* IE for the neighbouring cells which are controlled by the DRNC in the *Neighbouring FDD Cell Information* IE, the *Neighbouring TDD Cell Information* IE and the *Neighbouring TDD Cell Information LCR* IE.
- If available, the DRNC shall include the *SNA Information* IE for the concerned neighbouring cells in the *Neighbouring FDD Cell Information* IE, the *Neighbouring TDD Cell Information* IE and the *Neighbouring TDD Cell Information LCR* IE.

If there are GSM neighbouring cells to the cell(s) in which a radio link is established, the DRNC shall include the *Neighbouring GSM Cell Information IE* in the RADIO LINK ADDITION RESPONSE message for each of the GSM neighbouring cells. If available the DRNC shall include the *Cell Individual Offset IE*, and if the *Cell Individual Offset IE* alone cannot represent the value of the offset, the DRNC shall also include the *Extended GSM Cell Individual Offset IE* in the *Neighbouring GSM Cell Information IE*. If available the DRNC shall also include the *Coverage Indicator IE*, *Antenna Co-location Indicator IE* and *HCS Prio IE* in the *Neighbouring GSM Cell Information IE*. If available, the DRNC shall also include the *SNA Information IE* for the concerned neighbouring cells in the *Neighbouring GSM Cell Information IE*.

When receiving the *SNA Information IE* in the RADIO LINK ADDITION RESPONSE message, the SRNC should use it to restrict cell access based on SNA information. See also [40] for a broader description of the SNA access control.

If there are GERAN neighbouring cells to the cell(s) where a radio link is established, the DRNC shall include the *GERAN Cell Capability IE* in the *Neighbouring GSM Cell Information IE* that is included in the RADIO LINK ADDITION RESPONSE message for each of the GERAN cells.

If there are GERAN Iu-mode neighbouring cells to the cell(s) where a radio link is established, the DRNC shall include, if available, the *GERAN Classmark IE* in the *Neighbouring GSM Cell Information IE* that is included in the RADIO LINK ADDITION RESPONSE message for each of the GERAN Iu-mode neighbouring cells. Ref. [39] defines when the transmission of the *GERAN Classmark IE* will be required at the initiation of the Relocation Preparation procedure.

**[1.28Mcps TDD - Uplink Synchronisation Parameters LCR]:**

[1.28Mcps TDD - If the *Uplink Synchronisation Parameters LCR IE* is present, the DRNC shall use the indicated values of *Uplink synchronisation stepsize IE* and *Uplink synchronisation frequency IE* when evaluating the timing of the UL synchronisation.]

**[1.28Mcps TDD - Uplink Timing Advance Control LCR]:**

[1.28Mcps TDD - The DRNC shall include the *Uplink Timing Advance Control LCR IE* in the RADIO LINK ADDITION RESPONSE message.]

**General:**

If the RADIO LINK ADDITION REQUEST message includes the *RL Specific DCH Information IE*, the DRNC may use the transport layer address and the binding identifier received from the SRNC when establishing a transport bearer for the DCH or the set of co-ordinated DCHs.

[FDD - If the RADIO LINK ADDITION REQUEST message contains an *SSDT Cell Identity IE*, the DRNS shall, if supported, activate SSDT for the concerned new RL using the indicated SSDT Cell Identity.]

[FDD - If the RADIO LINK ADDITION REQUEST message includes the *Qth Parameter IE* in addition to the *SSDT Cell Identity IE*, the DRNS shall use the *Qth Parameter IE*, if Qth signalling is supported, when SSDT is activated in the concerned new RL.]

Depending on local configuration in the DRNS, the DRNC may include in the RADIO LINK ADDITION RESPONSE message the *UTRAN Access Point Position IE* and the geographical co-ordinates of the cell, represented either by the *Cell GAI IE* or by the *Cell GA Additional Shapes IE*. If the DRNC includes the *Cell GA Additional Shapes IE* in the RADIO LINK ADDITION RESPONSE message, it shall also include the *Cell GAI IE*.

For each Radio Link established in a cell in which at least one URA Identity is being broadcast, the DRNC shall include in the RADIO LINK ADDITION RESPONSE message a URA Information for this cell including the *URA ID IE*, the *Multiple URAs Indicator IE* indicating whether or not multiple URA Identities are being broadcast in the cell, and the *RNC-ID IEs* of all other RNCs that have at least one cell within the URA identified by the *URA ID IE*.

[FDD - If the UE has been allocated one or several DCH controlled by DRAC and if the DRNS supports the DRAC, the DRNC shall include in the RADIO LINK ADDITION RESPONSE message the *Secondary CCPCH Info IE* for the FACH in which the DRAC information is sent, for each Radio Link established in a cell in which DRAC is active. If the DRNS does not support DRAC, the DRNC shall not provide these IEs in the RADIO LINK ADDITION RESPONSE message.]



[3.84Mcps TDD - The DRNC shall include the *Secondary CCPCH Info TDD* IE in the RADIO LINK ADDITION RESPONSE message if at least one *DSCH Information Response* IE or *USCH Information Response* IE is included in the message and at least one DCH is configured for the radio link. The DRNC shall also include the *Secondary CCPCH Info TDD* IE in the RADIO LINK ADDITION RESPONSE message if at least one *DSCH Information Response* IE or *USCH Information Response* IE is included in the message and the SHCCH messages for this radio link will be transmitted over a different secondary CCPCH than selected by the UE from system information.]

[1.28 Mcps TDD - The DRNC shall include the *Secondary CCPCH Info TDD LCR* IE in the RADIO LINK ADDITION RESPONSE message if at least one *DSCH Information Response LCR* IE or *USCH Information Response LCR* IE is included in the message and at least one DCH is configured for the radio link. The DRNC shall also include the *Secondary CCPCH Info TDD LCR* IE in the RADIO LINK ADDITION RESPONSE message if at least one *DSCH Information Response LCR* IE or *USCH Information Response LCR* IE is included in the message and the SHCCH messages for this radio link will be transmitted over a different secondary CCPCH than selected by the UE from system information.]

If the *Permanent NAS UE Identity* IE is present in the RADIO LINK ADDITION REQUEST message, the DRNS shall store the information for the considered UE Context for the lifetime of the UE Context.

If the RADIO LINK ADDITION REQUEST message includes a *C-ID* IE corresponding to a cell reserved for operator use and the Permanent NAS UE Identity is available in the DRNC for the considered UE Context, the DRNC shall use this information to determine whether it can add the Radio Link on this cell or not.

If the HCS priority information is available in the DRNS, it shall include the *HCS Prio* IE for each of the established RLs in the RADIO LINK ADDITION RESPONSE message.

[FDD - If the accessed cell supports TFCI power control, the DRNC shall include the *TFCI PC Support Indicator* IE in the RADIO LINK ADDITION RESPONSE message.]

The DRNS shall start receiving on the new RL(s) after the RLs are successfully established.

#### [FDD - Radio Link Set Handling]:

[FDD - For each RL not having a common generation of the TPC commands in the DL with another RL, the DRNS shall assign to the RL a unique value for the *RL Set ID* IE which uniquely identifies the RL as an RL Set within the UE Context.]

[FDD - For all RLs having a common generation of the TPC commands in the DL with another new or existing RL, the DRNS shall assign to each RL the same value for the *RL Set ID* IE which uniquely identifies these RLs as members of the same RL Set within the UE Context.]

[FDD - After addition of the new RL(s), the UL out-of-sync algorithm defined in ref. [10] shall, for each of the previously existing and newly established RL Set(s), use the maximum value of the parameters *N\_OUTSYNC\_IND* and *T\_RLFAILURE* that are configured in the cells supporting the radio links of the RL Set. The UL in-sync algorithm defined in [10] shall, for each of the established RL Set(s), use the minimum value of the parameters *N\_INSYNC\_IND* that are configured in the cells supporting the radio links of the RL Set.]

[FDD - For all RLs having a common generation of E-RGCH and E-HICH related information with another RL, the DRNS shall assign to each RL the same value for the *E-DCH RL Set ID* IE which uniquely identifies these RLs as members of the same E-DCH RL Set within the UE Context.]

#### [FDD - E-DCH]:

If the *RL Information* IE in the RADIO LINK ADDITION REQUEST message contains the *RL specific E-DCH Information* IE for one Radio Link then:

- The DRNS shall setup the requested E-DCH resources on the Radio Link indicated by the *RL ID* IE in the *RL Information* IE.
- If the RADIO LINK ADDITION REQUEST message includes the *Transport Layer Address* IE and *Binding ID* IE in the *RL specific E-DCH Information* IE for an E-DCH MAC-d flow, then the DRNC may use the transport layer address and the binding identifier received from the SRNC when establishing a transport bearer for the concerned E-DCH MAC-d flow.

- The DRNC shall include the *E-AGCH and E-RGCH and E-HICH FDD Scrambling Code IE* and the *E-RGCH and E-HICH Channelisation Code IE* and the corresponding *Sequence Number for E-RGCH IE* and the *Sequence Number for E-HICH IE* in the *E-DCH FDD DL Control Channel Information IE* in the RADIO LINK ADDITION RESPONSE message.

If the RADIO LINK ADDITION REQUEST message contains the *Serving E-DCH RL ID IE* then the DRNC shall allocate an E-RNTI and include this E-RNTI and the Channelisation Code of the corresponding E-AGCH in the *E-DCH FDD DL Control Channel Information IE* in the *RL Information IE* for the indicated RL in the RADIO LINK ADDITION RESPONSE message.]

#### Response message:

If all requested RLs are successfully added, the DRNC shall respond with a RADIO LINK ADDITION RESPONSE message.

After sending the RADIO LINK ADDITION RESPONSE message the DRNS shall continuously attempt to obtain UL synchronisation on the Uu interface.

For each RL for which the *Delayed Activation IE* is not included in the RADIO LINK ADDITION REQUEST message the DRNS shall:

- [FDD - start transmission on the DL DPDCH(s) of the new RL as specified in ref. [4].]
- [TDD - start transmission on the new RL immediately as specified in ref. [4].]

For each RL for which the *Delayed Activation IE* is included in the RADIO LINK ADDITION REQUEST message, the DRNS shall:

- if the *Delayed Activation IE* indicates "Separate Indication":
  - not start any DL transmission for the concerning RL on the Uu interface;
- if the *Delayed Activation IE* indicates "CFN":
  - [FDD - start transmission on the DL DPDCH(s) of the new RL as specified in ref. [4], however never before the CFN indicated in the *Activation CFN IE*.]
  - [TDD - start transmission on the new RL at the CFN indicated in the *Activation CFN IE* as specified in ref. [4].]

### 8.3.2.3 Unsuccessful Operation

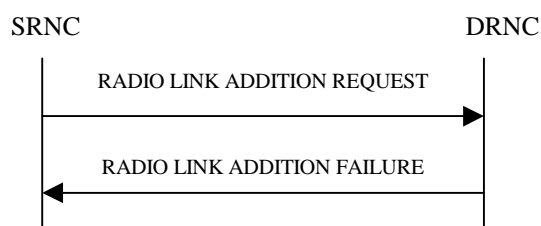

**Figure 8: Radio Link Addition procedure: Unsuccessful Operation**

If the establishment of at least one RL is unsuccessful, the DRNC shall respond with a RADIO LINK ADDITION FAILURE message. DRNC shall include in the RADIO LINK ADDITION FAILURE message a general *Cause IE* or a *Cause IE* for each failed radio link. The *Cause IE* indicates the reason for failure.

[FDD - If some RL(s) were established successfully, the DRNC shall indicate this in the RADIO LINK ADDITION FAILURE message in the same way as in the RADIO LINK ADDITION RESPONSE message.]

[FDD - If the accessed cell supports TFCI power control, the DRNC shall include the *TFCI PC Support Indicator IE* in the RADIO LINK ADDITION FAILURE message.]

Typical cause values are:

#### Radio Network Layer Causes:

- DL Radio Resources not Available;
- UL Radio Resources not Available;
- Combining Resources not Available;
- Combining not Supported
- Cell not Available;
- [FDD - Requested Tx Diversity Mode not Supported];
- Power Level not Supported;
- CM not Supported;
- Reconfiguration CFN not Elapsed;
- Number of DL Codes not Supported;
- Number of UL codes not Supported;
- [FDD - DPC mode change not Supported];
- Cell reserved for operator use;
- Delayed Activation not supported.
- [F-DPCH not supported.](#)

#### Transport Layer Causes:

- Transport Resource Unavailable.

#### Miscellaneous Causes:

- Control Processing Overload;
- HW Failure;
- Not enough User Plane Processing Resources.

### 8.3.2.4 Abnormal Conditions

If the RADIO LINK ADDITION REQUEST message includes a *C-ID* IE corresponding to a cell reserved for operator use and the Permanent NAS UE Identity is not available in the DRNC for the considered UE Context, the DRNC shall reject the procedure for this particular Radio Link and send the RADIO LINK ADDITION FAILURE message.

[FDD - If the RADIO LINK ADDITION REQUEST message includes the *Transmission Gap Pattern Sequence Status* IEs in the *Active Pattern Sequence Information* IE and it does not address exactly all ongoing compressed mode patterns the DRNS shall reject the Radio Link Addition procedure and shall respond with a RADIO LINK ADDITION FAILURE message with the *Cause* IE value "Invalid CM settings".]

[FDD - If the RADIO LINK ADDITION REQUEST message is used to establish a new RL without compressed mode when compressed mode is active for the existing RL(s) (as specified in subclause 8.3.2.2), and if at least one of the new RLs is to be established in a cell that has the same UARFCN (both UL and DL) as at least one cell with an already existing RL, the DRNS shall reject the Radio Link Addition procedure and shall respond with a RADIO LINK ADDITION FAILURE message with the cause value "Invalid CM settings".]

[FDD - If the power balancing is active with the Power Balancing Adjustment Type of the UE Context set to "Individual" in the existing RL(s) and if the *DL Reference Power* IEs are included in the *RL Information* IE but the *DL Reference Power* IE is not present for each RL in the *RL Information* IE, the DRNC shall reject the Radio Link Addition procedure and shall respond with a RADIO LINK ADDITION FAILURE message.]

[FDD - If the RADIO LINK ADDITION REQUEST message includes the *DL Reference Power* IEs in the *RL Information* IE but the power balancing is not active in the existing RL(s) or the power balancing is active with the Power Balancing Adjustment Type of the UE Context set to "Common" in the existing RL(s), the DRNC shall reject the

Radio Link Addition procedure and shall respond with a RADIO LINK ADDITION FAILURE message with the cause value "Power Balancing status not compatible".]

[FDD - If the RADIO LINK ADDITION REQUEST message includes the *Enhanced Primary CPICH Ec/No* IE, but not the *Primary CPICH Ec/No* IE, then the DRNC shall reject the procedure using the RADIO LINK ADDITION FAILURE message.]

If the RADIO LINK ADDITION REQUEST message includes the *Transport Layer Address* IE and the *Binding ID* IE in the *RL Specific DCH Information* IE included in the *RL Information* IE for a specific RL and the *Diversity Control Field* IE is set to "Must", the DRNC shall reject the Radio Link Addition procedure and respond with the RADIO LINK ADDITION FAILURE message.

If the RADIO LINK ADDITION REQUEST message includes the *Transport Layer Address* IE or the *Binding ID* IE, and not both are present for a transport bearer intended to be established, the DRNC shall reject the Radio Link Addition procedure and respond with the RADIO LINK ADDITION FAILURE message.

## 8.3.4 Synchronised Radio Link Reconfiguration Preparation

### 8.3.4.1 General

The Synchronised Radio Link Reconfiguration Preparation procedure is used to prepare a new configuration of Radio Link(s) related to one UE-UTRAN connection within a DRNS.

This procedure shall use the signalling bearer connection for the relevant UE Context.

The Synchronised Radio Link Reconfiguration Preparation procedure shall not be initiated if a Prepared Reconfiguration exists, as defined in subclause 3.1.

### 8.3.4.2 Successful Operation

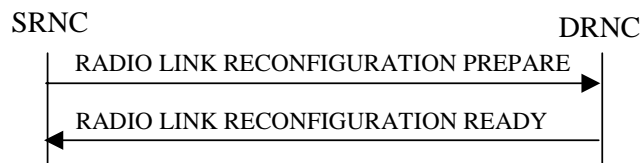

**Figure 10: Synchronised Radio Link Reconfiguration Preparation procedure, Successful Operation**

The Synchronised Radio Link Reconfiguration Preparation procedure is initiated by the SRNC by sending the RADIO LINK RECONFIGURATION PREPARE message to the DRNC.

Upon receipt, the DRNS shall reserve necessary resources for the new configuration of the Radio Link(s) according to the parameters given in the message. Unless specified below, the meaning of parameters is specified in other specifications.

If the RADIO LINK RECONFIGURATION PREPARE message includes the *Allowed Queuing Time* IE the DRNS may queue the request the time corresponding to the value of the *Allowed Queuing Time* IE before starting to execute the request.

The DRNS shall prioritise resource allocation for the RL(s) to be modified according to Annex A.

#### **DCH Modification:**

If the RADIO LINK RECONFIGURATION PREPARE message includes any *DCHs To Modify* IEs, the DRNS shall treat them each as follows:

- If the *DCHs To Modify* IE includes multiple *DCH Specific Info* IEs then the DRNS shall treat the DCHs in the *DCHs To Modify* IE as a set of co-ordinated DCHs. The DRNS shall include these DCHs in the new configuration only if it can include all of them in the new configuration.
- If the *DCHs To Modify* IE includes the *UL FP Mode* IE for a DCH or a set of co-ordinated DCHs to be modified, the DRNS shall apply the new FP Mode in the Uplink of the user plane for the DCH or the set of co-ordinated DCHs in the new configuration.
- If the *DCHs To Modify* IE includes the *ToAWS* IE for a DCH or a set of co-ordinated DCHs to be modified, the DRNS shall apply the new ToAWS in the user plane for the DCH or the set of co-ordinated DCHs in the new configuration.
- If the *DCHs To Modify* IE includes the *ToAWE* IE for a DCH or a set of co-ordinated DCHs to be modified, the DRNS shall apply the new ToAWE in the user plane for the DCH or the set of co-ordinated DCHs in the new configuration.
- If the *DCHs To Modify* IE contains a *DCH Specific Info* IE which includes the *Frame Handling Priority* IE for a DCH to be modified, the DRNS should store this information for this DCH in the new configuration. The received Frame Handling Priority should be used when prioritising between different frames in the downlink on the radio interface in congestion situations within the DRNS once the new configuration has been activated.
- If the *DCHs To Modify* IE contains a *DCH Specific Info* IE which includes the *Traffic Class* IE for a DCH to be modified, the DRNS should store this information for this DCH in the new configuration. The *Traffic Class* IE

may be used to determine the transport bearer characteristics to apply between DRNC and Node B for the related DCH or set of co-ordinated DCHs. The DRNC should ignore the *Traffic Class IE* if the *TrCH Source Statistics Descriptor IE* indicates the value "RRC".

- If the *DCHs To Modify IE* contains a *DCH Specific Info IE* which includes the *Transport Format Set IE* for the UL of a DCH to be modified, the DRNS shall apply the new Transport Format Set in the Uplink of this DCH in the new configuration.
- If the *DCHs to Modify IE* includes the *TNL QoS IE* for a DCH or a set of co-ordinated DCHs to be modified and if ALCAP is not used, the DRNS may store this information for this DCH in the new configuration. The *TNL QoS IE* may be used to determine the transport bearer characteristics to apply in the uplink for the related DCH or set of co-ordinated DCHs.
- If the *DCHs To Modify IE* contains a *DCH Specific Info IE* which includes the *Transport Format Set IE* for the DL of a DCH to be modified, the DRNS shall apply the new Transport Format Set in the Downlink of this DCH in the new configuration.
- If the *DCHs To Modify IE* contains a *DCH Specific Info IE* which includes the *Allocation/Retention Priority IE*, the DRNS shall apply the new Allocation/Retention Priority to this DCH in the new configuration according to Annex A.
- [FDD - If the *DCHs To Modify IE* contains a *DRAC Control IE* set to "requested" and if the DRNS supports the DRAC, the DRNC shall include in the RADIO LINK RECONFIGURATION READY message the *Secondary CCPCH Info IE* for the FACH in which the DRAC information is sent, for each Radio Link established in a cell in which DRAC is active. If the DRNS does not support DRAC, DRNC shall not provide these IEs in the RADIO LINK RECONFIGURATION READY message.]
- [TDD - If the *DCHs To Modify IE* includes the *CCTrCH ID IE* for the UL, the DRNS shall map the DCH onto the referenced UL CCTrCH in the new configuration.]
- [TDD - If the *DCHs To Modify IE* includes the *CCTrCH ID IE* for the DL, the DRNS shall map the DCH onto the referenced DL CCTrCH in the new configuration.]
- If the *DCHs To Modify IE* contains a *DCH Specific Info IE* which includes the *Guaranteed Rate Information IE*, the DRNS shall treat the included IEs according to the following:
  - If the *Guaranteed Rate Information IE* includes the *Guaranteed UL Rate IE*, the DRNS shall apply the new Guaranteed Rate in the uplink of this DCH in the new configuration. The DRNS may decide to request the SRNC to limit the user rate in the uplink of the DCH at any point in time after activating the new configuration. The DRNS may request the SRNC to reduce the user rate of the uplink of the DCH below the guaranteed bit rate, however, whenever possible the DRNS should request the SRNC to reduce the user rate between the maximum bit rate and the guaranteed bit rate.
  - If the *Guaranteed Rate Information IE* includes the *Guaranteed DL Rate IE*, the DRNS shall apply the new Guaranteed Rate in the downlink of this DCH in the new configuration. The DRNS may decide to request the SRNC to limit the user rate in the downlink of the DCH at any point in time after activating the new configuration. The DRNS may request the SRNC to reduce the user rate of the downlink of the DCH below the guaranteed bit rate, however, whenever possible the DRNS should request the SRNC to reduce the user rate between the maximum bit rate and the guaranteed bit rate.

#### **DCH Addition:**

If the RADIO LINK RECONFIGURATION PREPARE message includes any *DCHs To Add IEs*, the DRNS shall treat them each as follows:

- The DRNS shall reserve necessary resources for the new configuration of the Radio Link(s) according to the parameters given in the message and include these DCH in the new configuration.
- If the *DCH Information IE* includes a *DCHs To Add IE* with multiple *DCH Specific Info IEs*, the DRNS shall treat the DCHs in the *DCHs To Add IE* as a set of co-ordinated DCHs. The DRNS shall include these DCHs in the new configuration only if it can include all of them in the new configuration.
- If the *DCH Specific Info IE* includes the *Unidirectional DCH Indicator IE* set to "Uplink DCH only", the DRNS shall ignore the *Transport Format Set IE* for the downlink for this DCH. As a consequence this DCH is not included as a part of the downlink CCTrCH.

- [TDD - If the *DCH Specific Info* IE includes the *Unidirectional DCH Indicator* IE set to "Downlink DCH only", the DRNS shall ignore the *Transport Format Set* IE for the uplink for this DCH. As a consequence this DCH is not included as a part of the uplink CCTrCH.]
- [FDD - For each DCH which do not belong to a set of co-ordinated DCHs and which includes a *QE-Selector* IE set to "selected", the DRNS shall use the Transport channel BER from that DCH for the QE in the UL data frames. If no Transport channel BER is available for the selected DCH, the DRNS shall use the Physical channel BER for the QE, ref. [4]. If the *QE-Selector* IE is set to "non-selected", the DRNS shall use the Physical channel BER for the QE in the UL data frames, ref. [4].]
- For a set of co-ordinated DCHs, the DRNS shall use the Transport channel BER from the DCH with the *QE-Selector* IE set to "selected" for the QE in the UL data frames, ref. [4]. [FDD - If no Transport channel BER is available for the selected DCH, the DRNS shall use the Physical channel BER for the QE, ref. [4]. If all DCHs have the *QE-Selector* IE set to "non-selected", the DRNS shall use the Physical channel BER for the QE, ref. [4]. [TDD - If no Transport channel BER is available for the selected DCH, the DRNS shall use 0 for the QE, ref. [4].]
- The DRNS should store the *Frame Handling Priority* IE received for a DCH to be added in the new configuration. The received Frame Handling Priority should be used when prioritising between different frames in the downlink on the Uu interface in congestion situations within the DRNS once the new configuration has been activated.
- If the *TNL QoS* IE is included for a DCH or a set of co-ordinated DCHs and if ALCAP is not used, the DRNS may use this information to determine the transport bearer characteristics to apply for the uplink for the related DCH or set of co-ordinated DCHs.
- The DRNS should store the *Traffic Class* IE received for a DCH to be added in the new configuration. The *Traffic Class* IE may be used to determine the transport bearer characteristics to apply between DRNC and Node B for the related DCH or set of co-ordinated DCHs. The DRNC should ignore the *Traffic Class* IE if the *TrCH Source Statistics Descriptor* IE indicates the value "RRC".
- The DRNS shall use the included *UL FP Mode* IE for a DCH or a set of co-ordinated DCHs to be added as the new FP Mode in the Uplink of the user plane for the DCH or the set of co-ordinated DCHs in the new configuration.
- The DRNS shall use the included *ToAWS* IE for a DCH or a set of co-ordinated DCHs to be added as the new Time of Arrival Window Startpoint in the user plane for the DCH or the set of co-ordinated DCHs in the new configuration.
- The DRNS shall use the included *ToAWE* IE for a DCH or a set of co-ordinated DCHs to be added as the new Time of Arrival Window Endpoint in the user plane for the DCH or the set of co-ordinated DCHs in the new configuration.
- [TDD - The DRNC shall include the *Secondary CCPCH Info TDD* IE in the RADIO LINK RECONFIGURATION READY message if at least one DSCH or USCH exists in the new configuration.]
- [FDD - If the *DRAC Control* IE is set to "requested" in the *DCH Specific Info* IE for at least one DCH and if the DRNS supports the DRAC, the DRNC shall indicate in the RADIO LINK RECONFIGURATION READY message the *Secondary CCPCH Info* IE for the FACH in which the DRAC information is sent, for each radio link supported by a cell in which DRAC is active. If the DRNS does not support DRAC, the DRNC shall not provide these IEs in the RADIO LINK RECONFIGURATION READY message.]
- If the *DCHs To Add* IE contains a *DCH Specific Info* IE which includes the *Guaranteed Rate Information* IE, the DRNS shall treat the included IEs according to the following:
  - If the *Guaranteed Rate Information* IE includes the *Guaranteed UL Rate* IE, the DRNS shall apply the new Guaranteed Rate in the uplink of this DCH in the new configuration. The DRNS may decide to request the SRNC to limit the user rate of the uplink of the DCH at any point in time after activating the new configuration. The DRNS may request the SRNC to reduce the user rate of the uplink of the DCH below the guaranteed bit rate, however, whenever possible the DRNS should request the SRNC to reduce the user rate between the maximum bit rate and the guaranteed bit rate. If the *DCH Specific Info* IE in the *DCHs To Add* IE does not include the *Guaranteed UL Rate* IE, the DRNS shall not limit the user rate of the uplink of the DCH.

- If the *Guaranteed Rate Information* IE includes the *Guaranteed DL Rate* IE, the DRNS shall apply the new Guaranteed Rate in the downlink of this DCH in the new configuration. The DRNS may decide to request the SRNC to limit the user rate of the downlink of the DCH at any point in time after activating the new configuration. The DRNS may request the SRNC to reduce the user rate of the downlink of the DCH below the guaranteed bit rate, however, whenever possible the DRNS should request the SRNC to reduce the user rate between the maximum bit rate and the guaranteed bit rate. If the *DCH Specific Info* IE in the *DCHs To Add* IE does not include the *Guaranteed DL Rate* IE, the DRNS shall not limit the user rate of the downlink of the DCH.
- [TDD - The DRNS shall apply the *CCTrCH ID* IE (for the DL) in the Downlink of this DCH in the new configuration.]
- [TDD - The DRNS shall apply the *CCTrCH ID* IE (for the UL) in the Uplink of this DCH in the new configuration.]

#### DCH Deletion:

If the RADIO LINK RECONFIGURATION PREPARE message includes any *DCH To Delete*, the DRNS shall not include the referenced DCHs in the new configuration.

If all of the DCHs belonging to a set of co-ordinated DCHs are requested to be deleted, the DRNS shall not include this set of co-ordinated DCHs in the new configuration.

#### Physical Channel Modification:

[FDD - If the RADIO LINK RECONFIGURATION PREPARE message includes an *UL DPCH Information* IE, the DRNS shall apply the parameters to the new configuration as follows:]

- [FDD - If the *UL DPCH Information* IE includes the *Uplink Scrambling Code* IE, the DRNS shall apply this Uplink Scrambling Code to the new configuration.]
- [FDD - If the *UL DPCH Information* IE includes the *Min UL Channelisation Code Length* IE, the DRNS shall apply the new Min UL Channelisation Code Length in the new configuration. The DRNS shall apply the contents of the *Max Number of UL DPDCHs* IE (if it is included) in the new configuration.]
- [FDD - If the *UL DPCH Information* IE includes the *TFCS* IE, the DRNS shall use the *TFCS* IE for the UL when reserving resources for the uplink of the new configuration. The DRNS shall apply the new *TFCS* in the uplink of the new configuration.]
- [FDD - If the *UL DPCH Information* IE includes the *UL DPCCH Slot Format* IE, the DRNS shall apply the new Uplink *DPCCH Slot Format* to the new configuration.]
- [FDD - If the *UL DPCH Information* IE includes the *UL SIR Target* IE, the DRNS shall use the value for the UL inner loop power control when the new configuration is being used.]
- [FDD - If the *UL DPCH Information* IE includes the *Puncture Limit* IE, the DRNS shall apply the value in the uplink of the new configuration.]
- [FDD - If the *UL DPCH Information* IE includes the *Diversity Mode* IE, the DRNS shall apply diversity according to the given value.]
- [FDD - If the *UL DPCH Information* IE includes an *SSDT Cell Identity Length* IE and/or an *S-Field Length* IE, the DRNS shall apply the values in the new configuration.]

[FDD - If the RADIO LINK RECONFIGURATION PREPARE message includes a *DL DPCH Information* IE and the concerned UE Context is configured to use F-DPCH in the downlink in the old configuration, the DRNS shall configure the concerned UE Context to use DPCH in the downlink in the new configuration. In this case, if at least one Transmission Gap Pattern Sequence is configured with an SF/2 downlink compressed mode method in the new configuration, the DRNS shall include the *Transmission Gap Pattern Sequence Scrambling Code Information* IE in the RADIO LINK RECONFIGURATION READY message indicating for each Channelisation Code whether the alternative scrambling code shall be used or not].

[FDD - If the RADIO LINK RECONFIGURATION PREPARE message includes the *DL DPCH Power Information* IE, the DRNS shall use the information contained in it for the power settings of the DL DPCH. In particular, if the received *Inner Loop DL PC Status* IE is set to "Active", the DRNS shall activate the inner loop DL power control for all



RLs. If Inner Loop DL PC Status IE is set to "Inactive", the DRNS shall deactivate the inner loop DL power control for all RLs according to ref. [10]. Furthermore, the DRNC shall include the DL Code Information IE in the RADIO LINK RECONFIGURATION READY.]

[FDD - If the RADIO LINK RECONFIGURATION PREPARE message includes a DL DPCH Information IE, the DRNS shall apply the parameters to the new configuration as follows:]

- [FDD - If the DL DPCH Information IE includes the Number of DL Channelisation Codes IE, the DRNS shall allocate given number of Downlink Channelisation Codes per Radio Link and apply the new Downlink Channelisation Code(s) to the new configuration. Each Downlink Channelisation Code allocated for the new configuration shall be included in the RADIO LINK RECONFIGURATION READY message within the DL Code Information IE as a FDD DL Channelisation Code Number IE when sent to the SRNC. If some Transmission Gap Pattern sequences using "SF/2" method are already initialised in the DRNS, DRNC shall include the Transmission Gap Pattern Sequence Scrambling Code Information IE in the RADIO LINK RECONFIGURATION READY message in case the DRNS selects to change the Scrambling code change method for one or more DL Channelisation Code.]
- [FDD - When more than one DL DPDCH are assigned per RL, the segmented physical channel shall be mapped on to DL DPDCHs according to [8]. When  $p$  number of DL DPDCHs are assigned to each RL, the first pair of DL Scrambling Code and FDD DL Channelisation Code Number corresponds to "PhCH number 1", the second to "PhCH number 2", and so on until the  $p$ th to "PhCH number  $p$ ".]
- [FDD - If the DL DPCH Information IE includes the TFCS IE, the DRNS shall use the TFCS IE for the DL when reserving resources for the downlink of the new configuration. The DRNS shall apply the new TFCS in the Downlink of the new configuration.]
- [FDD - If the DL DPCH Information IE includes the DL DPCH Slot Format IE, the DRNS shall apply the new slot format used in DPCH in DL.]
- [FDD - If the DL DPCH Information IE includes the TFCI Signalling Mode IE, the DRNS shall apply the new signalling mode of the TFCI.]
- [FDD - If the DL DPCH Information IE includes the Multiplexing Position IE, the DRNS shall apply the new parameter to define whether fixed or flexible positions of transport channels shall be used in the physical channel.]
- [FDD - If the DL DPCH Information IE includes the Limited Power Increase IE set to "Used", the DRNS shall, if supported, use Limited Power Increase according to ref. [10] subclause 5.2.1 for the inner loop DL power control in the new configuration.]
- [FDD - If the DL DPCH Information IE includes the Limited Power Increase IE set to "Not Used", the DRNS shall not use Limited Power Increase for the inner loop DL power control in the new configuration.]
- [FDD - If the RADIO LINK RECONFIGURATION PREPARE message does not include the Length of TFCI2 IE and the Split type IE is present with the value "Hard", then the DRNS shall assume the length of the TFCI (field 2) is 5 bits.]
- [FDD - If the RADIO LINK RECONFIGURATION PREPARE message includes Split Type IE, then the DRNS shall apply this information to the new configuration of TFCI.]
- [FDD - If the DL DPCH Information IE includes the Length of TFCI2 IE, the DRNS shall apply this information to the length of TFCI(field 2) in the new configuration.]

[FDD - If the RADIO LINK RECONFIGURATION PREPARE message includes the F-DPCH Information IE, the DRNS shall configure the concerned UE Context to use F-DPCH in the downlink in the new configuration.]

[FDD - If the RADIO LINK RECONFIGURATION PREPARE message includes the Transmission Gap Pattern Sequence Information IE, the DRNS shall store the new information about the Transmission Gap Pattern Sequences to be used in the new Compressed Mode Configuration. Any Transmission Gap Pattern Sequences already existing in the previous Compressed Mode Configuration are replaced by the new sequences once the new Compressed Mode Configuration has been activated. This new Compressed Mode Configuration shall be valid in the DRNS until the next Compressed Mode Configuration is configured in the DRNS or until the last Radio Link is deleted.]

[FDD - If the RADIO LINK RECONFIGURATION PREPARE message includes the Transmission Gap Pattern Sequence Information IE and the Downlink Compressed Mode Method IE in one or more Transmission Gap Pattern

Sequence within the *Transmission Gap Pattern Sequence Information* IE is set to "SF/2"<sup>1</sup> and the UE Context is configured to use DPCH in the downlink in the new configuration, the DRNC shall include the *Transmission Gap Pattern Sequence Scrambling Code Information* IE in the RADIO LINK RECONFIGURATION READY message indicating for each Channelisation Code whether the alternative scrambling code shall be used or not].

[FDD - E-DPCH Handling: If the *E-DPCH Information* IE is included, the *UL DPDCH Indicator for E-DCH operation* IE in the *UL DPCH Information* shall be present as well. If the *UL DPDCH Indicator for E-DCH operation* IE is set to "UL DPDCH not present" the *Min UL Channelisation Code Length* IE, the *Puncture Limit* IE and the *TFCS* IE, within the *UL DPCH Information* IE shall be ignored.]

[FDD - If the RADIO LINK RECONFIGURATION PREPARE message includes an *E-DPCH Information* IE, the DRNS shall apply the parameters to the new configuration as follows:]

- [FDD - If the *E-DPCH Information* IE includes the *Min UL Channelisation Code Length for EDCH FDD* IE, the DRNS shall apply the new Min UL Channelisation Code Length in the new configuration. The DRNS shall apply the contents of the *Max Number of E-DPDCHs* IE (if it is included) in the new configuration.]
- [FDD - If the *E-DPCH Information* IE includes the *Puncture Limit* IE, the DRNS shall apply the value in the uplink of the new configuration]
- [FDD - If the *E-DPCH Information* IE includes the *E-TFCS* IE, the DRNS shall use the *E-TFCS* IE for the E-DCH when reserving resources for the uplink of the new configuration. The DRNS shall apply the new TFCS in the uplink of the new configuration.]
- [FDD - If the *E-DPCH Information* IE includes the *E-DPCCH Slot Format* IE, the DRNS shall apply the new *E-DPCCH Slot Format* to the new configuration.]
- [FDD - If the *E-DPCH Information* IE includes the *E-TTI* IE, the DRNS shall use the value when the new configuration is being used.]

#### [TDD - UL/DL CCTrCH Modification]

[TDD - If the RADIO LINK RECONFIGURATION PREPARE message includes any *UL CCTrCH To Modify* IEs or *DL CCTrCH To Modify* IEs, then the DRNS shall treat them each as follows:]

- [TDD - If any of the *UL CCTrCH To Modify* IEs or *DL CCTrCH To Modify* IEs includes any of the *TFCS* IE, *TFCI coding* IE, *Puncture limit* IE, or *TPC CCTrCH ID* IEs the DRNS shall apply these as the new values, otherwise the previous values specified for this CCTrCH are still applicable.]
- [TDD - If any of the following listed DPCH information IEs are modified in the new prepared configuration, the DRNC shall include in the RADIO LINK RECONFIGURATION READY message the IEs indicating the new values: *Repetition Period* IE, *Repetition Length* IE, *TDD DPCH Offset* IE, [3.84Mcps TDD - *UL Timeslot Information* IE,] [1.28Mcps TDD - *UL Timeslot Information LCR* IE,] [3.84Mcps TDD - *DL Timeslot Information* IE,] [1.28Mcps TDD - *DL Timeslot Information LCR* IE,] [3.84Mcps TDD - *Midamble Shift And Burst Type* IE,] [1.28Mcps TDD - *Midamble Shift LCR* IE,] *TFCI Presence* IE, [3.84Mcps TDD - *TDD Channelisation Code* IE,] [1.28Mcps TDD - and/or *TDD Channelisation Code LCR* IE,] [1.28Mcps TDD - *TDD UL DPCH Time Slot Format LCR* IE or *TDD DL DPCH Time Slot Format LCR* IE].]
- [1.28Mcps TDD - If the *UL CCTrCH To Modify* IE includes the *UL SIR Target* IE, the DRNS shall use the value for the UL inner loop power control according [12] and [22] in the new configuration.]
- [TDD - If any of the *DL CCTrCH To Modify* IEs includes any *TPC CCTrCH ID* IEs, the DRNS shall apply these as the new values, otherwise the previous values specified for this CCTrCH are still applicable.]
- [1.28Mcps TDD - If the *UL CCTrCH to Modify* IE includes the *TDD TPC Uplink Step Size* IE, the DRNS shall apply this value to the uplink TPC step size in the new configuration.]
- [TDD - If the *DL CCTrCH to Modify* IE includes the *TDD TPC Downlink Step Size* IE, the DRNS shall apply this value to the downlink TPC step size in the new configuration.]

#### [TDD - UL/DL CCTrCH Addition]

[TDD - If the RADIO LINK RECONFIGURATION PREPARE message includes any *UL CCTrCH To Add* IEs or *DL CCTrCH To Add* IEs, the DRNS shall include this CCTrCH in the new configuration.]

[TDD - If the RADIO LINK RECONFIGURATION PREPARE message includes any *DCHs to Add* IEs, the DRNC shall include in the RADIO LINK RECONFIGURATION READY message the DPCH information in [3.84Mcps TDD - *UL DPCH to be Added* IE/*DL DPCH to be Added* IEs] [1.28Mcps TDD - *UL DPCH to be Added* LCR IE/*DL DPCH to be Added* LCR IEs] [3.84Mcps TDD - If no UL DPCH is active before a reconfiguration which adds an UL DPCH, and if a valid Rx Timing Deviation measurement is known in DRNC, then the DRNC shall include the *Rx Timing Deviation* IE in the RADIO LINK RECONFIGURATION READY message.]

[TDD - If the RADIO LINK RECONFIGURATION PREPARE message includes the *TDD TPC Downlink Step Size* IE within a *DL CCTrCH To Add* IE, the DRNS shall set the TPC step size of that CCTrCH to that value, otherwise the DRNS shall use the same value as the lowest numbered DL CCTrCH in the current configuration.]

[1.28Mcps TDD - The DRNS shall use the *UL SIR Target* IE in the *UL CCTrCH To Add* IE as the UL SIR value for the inner loop power control for this CCTrCH according [12] and [22] in the new configuration.]

[TDD - If any of the *DL CCTrCH To Add* IEs includes any *TPC CCTrCH ID* IEs, the DRNS shall configure the identified UL CCTrCHs with TPC according to the parameters given in the message.]

[1.28Mcps TDD - If the *UL CCTrCH To Add* IE includes *TDD TPC Uplink Step Size* IE, the DRNS shall apply the uplink TPC step size in the new configuration.]

#### [TDD - UL/DL CCTrCH Deletion]

[TDD - If the RADIO LINK RECONFIGURATION PREPARE message includes any *UL CCTrCH To Delete* IEs or *DL CCTrCH To Delete* IEs, the DRNS shall remove this CCTrCH in the new configuration, and the DRNC shall include in the RADIO LINK RECONFIGURATION READY message corresponding *UL DPCH to be Deleted* IEs and *DL DPCH to be Deleted* IEs.]

#### SSDT Activation/Deactivation:

- [FDD - If the *RL Information* IE includes the *SSDT Indication* IE set to "SSDT Active in the UE", then in the new configuration the DRNS shall activate SSDT, if supported, using the *SSDT Cell Identity* IE in *RL Information* IE, and the *SSDT Cell Identity Length* IE in *UL DPCH Information* IE.]
- [FDD - If the *RL Information* IE includes the *Qth Parameter* IE and the *SSDT Indication* IE set to "SSDT Active in the UE", the DRNS shall use the *Qth Parameter* IE, if Qth signalling is supported, when SSDT is activated in the new configuration.]
- [FDD - If the *RL Information* IE includes the *SSDT Indication* IE set to "SSDT not Active in the UE", the DRNS shall deactivate SSDT in the new configuration.]

#### DL Power Control:

- [FDD - If the *RL Information* IE includes the *DL Reference Power* IEs and power balancing is active, DRNS shall update the reference power of the power balancing in the indicated RL(s), if updating of power balancing parameters by the RADIO LINK RECONFIGURATION PREPARE message is supported, at the CFN in the RADIO LINK RECONFIGURATION COMMIT message, according to subclause 8.3.15, using the *DL Reference Power* IE. If the CFN modulo the value of the *Adjustment Period* IE is not equal to 0, the power balancing continues with the old reference power until the end of the current adjustment period, and the updated reference power shall be used from the next adjustment period.]

[FDD - If updating of power balancing parameters by the RADIO LINK RECONFIGURATION PREPARE message is supported by the DRNS, the DRNC shall include the *DL Power Balancing Updated Indicator* IE in the *RL Information Response* IE for each affected RL in the RADIO LINK RECONFIGURATION READY message.]

#### DSCH Addition/Modification/Deletion:

If the RADIO LINK RECONFIGURATION PREPARE message includes any *DSCH To Add*, *DSCH To Modify* or *DSCH To Delete* IEs, then the DRNS shall use this information to add/modify/delete the indicated DSCH channels to/from the radio link, in the same way as the DCH info is used to add/modify/release DCHs.

If the RADIO LINK RECONFIGURATION PREPARE message includes any *DSCH To Add* IE, then the DRNS shall use the *Allocation/Retention Priority* IE, *Scheduling Priority Indicator* IE and *TrCH Source Statistics Descriptor* IE to define a set of DSCH Priority classes each of which is associated with a set of supported MAC-c/sh SDU lengths.

The DRNC shall include in the RADIO LINK RECONFIGURATION READY message both the *Transport Layer Address IE* and the *Binding ID IE* for the transport bearer to be established for each added DSCH.

If the RADIO LINK RECONFIGURATION PREPARE message includes any *DSCH To Add IE*, then the DRNS may use the *Traffic Class IE* to determine the transport bearer characteristics to apply between DRNC and Node B for the related DSCHs.

[FDD - If the *DSCHs To Add IE* includes the *Enhanced DSCH PC IE*, the DRNS shall activate enhanced DSCH power control in accordance with ref. [10] subclause 5.2.2, if supported, using either:]

- [FDD - the *SSDT Cell Identity for EDSCHPC IE* in the *RL Information IE*, if the *SSDT Cell Identity IE* is not included in the *RL Information IE* or]
- [FDD - the *SSDT Cell Identity IE* in the *RL Information IE*, if both the *SSDT Cell Identity IE* and the *SSDT Cell Identity for EDSCHPC* are included in the *RL Information IE*.]

[FDD - together with the *SSDT Cell Identity Length IE* in *UL DPCH Information IE*, and *Enhanced DSCH PC IE*, in the new configuration.]

[FDD - If the enhanced DSCH power control is activated and the TFCI PC Mode 2 is supported, the primary/secondary status determination in the enhanced DSCH power control shall be applied to the TFCI power control in DSCH hard split mode.]

If the RADIO LINK RECONFIGURATION PREPARE message includes any *DSCH To Modify IE*, then the DRNS shall treat them each as follows:

- The DRNC shall include in the RADIO LINK RECONFIGURATION READY message both the *Transport Layer Address IE* and the *Binding ID IE* for any new transport bearer to be established for each modified DSCH.
- [FDD - If the *DSCH To Modify IE* includes any *DSCH Info IEs*, then the DRNS shall treat them each as follows:]
  - [FDD - If the *DSCH Info IE* includes any of the *Allocation/Retention Priority IE*, *Scheduling Priority Indicator IE* or *TrCH Source Statistics Descriptor IE*, the DRNS shall use them to update the set of DSCH Priority classes each of which is associated with a set of supported MAC-c/sh SDU lengths.]
  - [FDD - If the *DSCH Info IE* includes any of the *Transport Format Set IE* or *BLER IE*, the DRNS shall apply the parameters to the new configuration.]
  - [FDD - If the *DSCH Info IE* includes the *Traffic Class IE*, the DRNS may use this information to determine the transport bearer characteristics to apply between DRNC and Node B for the related DSCHs.]
- [FDD - If the *DSCH To Modify IE* includes the *PDSCH RL ID IE*, then the DRNS shall use it as the new DSCH RL identifier.]
- [FDD - If the indicated PDSCH RL ID is in the DRNS and there was no DSCH-RNTI allocated to the UE Context, the DRNC shall allocate a DSCH-RNTI to the UE Context and include the *DSCH-RNTI IE* in the RADIO LINK RECONFIGURATION READY message.]
- [FDD - If the indicated PDSCH RL ID is in the DRNS and there was a DSCH-RNTI allocated to the UE Context, the DRNC shall allocate a new DSCH-RNTI to the UE Context, release the old DSCH-RNTI and include the *DSCH-RNTI IE* in the RADIO LINK RECONFIGURATION READY message.]
- [FDD - If the indicated PDSCH RL ID is not in the DRNS and there was a DSCH-RNTI allocated to the UE Context, the DRNC shall release this DSCH-RNTI.]
- [FDD - If the *DSCH To Modify IE* includes the *Transport Format Combination Set IE*, then the DRNS shall use it as the new Transport Format Combination Set associated with the DSCH.]
- [TDD - If the *DSCHs To Modify IE* includes the *CCTrCH ID IE*, then the DRNS shall map the DSCH onto the referenced DL CCTrCH.]
- [TDD - If the *DSCHs To Modify IE* includes any of the *Allocation/Retention Priority IE*, *Scheduling Priority Indicator IE* or *TrCH Source Statistics Descriptor IE*, the DRNS shall use them to update the set of DSCH Priority classes each of which is associated with a set of supported MAC-c/sh SDU lengths.]

- [TDD - If the *DSCHs To Modify* IE includes any of the *Transport Format Set* IE or *BLER* IE, the DRNS shall apply the parameters to the new configuration.]
  - [TDD - If the *DSCHs To Modify* IE includes the *Traffic Class* IE, the DRNS may use this information to determine the transport bearer characteristics to apply between DRNC and Node B for the related DSCHs.]
  - [FDD - If the *DSCHs To Modify* IE includes the *Enhanced DSCH PC Indicator* IE set to "Enhanced DSCH PC Active in the UE ", the DRNS shall activate enhanced DSCH power control in accordance with ref. [10] subclause 5.2.2, if supported, using either:]
    - [FDD - the *SSDT Cell Identity for EDSCHPC* IE in *RL Information* IE, if the *SSDT Cell Identity* IE is not included in the *RL Information* IE or]
    - [FDD - the *SSDT Cell Identity* IE in the *RL Information* IE, if both the *SSDT Cell Identity* IE and the *SSDT Cell Identity for EDSCHPC* are included in the *RL Information* IE.]

[FDD - together with the *SSDT Cell Identity Length* IE in *UL DPCH Information* IE, and *Enhanced DSCH PC* IE, in the new configuration.]
  - [FDD - If the *DSCHs To Modify* IE includes the *Enhanced DSCH PC Indicator* IE set to "Enhanced DSCH PC not Active in the UE", the DRNS shall deactivate enhanced DSCH power control in the new configuration.]
- [FDD - If the enhanced DSCH power control is activated and the TFCI PC Mode 2 is supported, the primary/secondary status determination in the enhanced DSCH power control shall be applied to the TFCI power control in DSCH hard split mode.]

[FDD - If the RADIO LINK RECONFIGURATION PREPARE message includes a *DSCHs To Delete* IE requesting the deletion of all DSCH resources for the UE Context, then the DRNC shall release the DSCH-RNTI allocated to the UE Context, if there was one.]

[3.84 Mcps TDD - The DRNC shall include the *Secondary CCPCH Info TDD* IE in the RADIO LINK RECONFIGURATION READY message if a DSCH is added and at least one DCH exists in the new configuration. The DRNC shall also include the *Secondary CCPCH Info TDD* IE in the RADIO LINK RECONFIGURATION READY message if the SHCCH messages for this radio link will be transmitted over a different secondary CCPCH than selected by the UE from system information.]

[FDD - If the RADIO LINK RECONFIGURATION PREPARE message includes the *Enhanced DSCH PC Indicator* IE set to "Enhanced DSCH PC not Active in the UE", the DRNS shall deactivate enhanced DSCH power control in the new configuration.]

If the requested modifications are allowed by the DRNS and the DRNS has successfully reserved the required resources for the new configuration of the Radio Link(s), it shall respond to the SRNC with the RADIO LINK RECONFIGURATION READY message.

The DRNC shall include the *DSCH Initial Window Size* IE in the RADIO LINK RECONFIGURATION READY message for each DSCH, if the DRNS allows the SRNC to start transmission of MAC-c/sh SDUs before the DRNS has allocated capacity on user plane as described in [32].

#### [TDD USCH Addition/Modification/Deletion]

[TDD - If the RADIO LINK RECONFIGURATION PREPARE message includes any *USCH To Modify*, *USCH To Add* or *USCH To Delete* IEs, then the DRNS shall use this information to add/modify/delete the indicated USCH channels to/from the radio link, in the same way as the DCH info is used to add/modify/release DCHs.]

[TDD - If the RADIO LINK RECONFIGURATION PREPARE message includes any *USCH To Add* IE, then, the DRNS shall use the *Allocation/Retention Priority* IE, *Scheduling Priority Indicator* IE and *TrCH Source Statistics Descriptor* IE to define a set of USCH Priority classes each of which is associated with a set of supported MAC-c/sh SDU lengths.]

[TDD - If the RADIO LINK RECONFIGURATION PREPARE message includes any *USCH To Add* IE, then the DRNS may use the *Traffic Class* IE to determine the transport bearer characteristics to apply between DRNC and Node B for the related USCHs.]

[TDD – If the RADIO LINK RECONFIGURATION PREPARE message includes any *USCH To Add* IE, if the *TNL QoS* IE is included and if ALCAP is not used, the DRNS may use the *TNL QoS* IE to determine the transport bearer characteristics to apply for the related USCHs.]

[TDD - The DRNC shall include in the RADIO LINK RECONFIGURATION READY message both the *Transport Layer Address* IE and the *Binding ID* IE for the transport bearer to be established for each added USCH.]

[TDD - If the RADIO LINK RECONFIGURATION PREPARE message includes any *USCH To Modify* IE, then the DRNS shall treat them each as follows:]

- [TDD - If the *USCH To Modify* IE includes any of the Allocation/Retention Priority IE, Scheduling Priority Indicator IE or TrCH Source Statistics Descriptor IE, the DRNS shall use them to update the set of USCH Priority classes.]
- [TDD - If the *USCH To Modify* IE includes any of the *CCTrCH ID* IE, *Transport Format Set* IE, *BLER* IE or *RB Info* IE, the DRNS shall apply the parameters to the new configuration.]
- [TDD - If the *USCHs To Modify* IE includes the *Traffic Class* IE, the DRNS may use this information to determine the transport bearer characteristics to apply between DRNC and Node B for the related USCHs.]
- [TDD - The DRNC shall include the *Secondary CCPCH Info TDD* IE in the RADIO LINK RECONFIGURATION READY message if a USCH is added and at least one DCH exists in the new configuration. The DRNC shall also include the *Secondary CCPCH Info TDD* IE in the RADIO LINK RECONFIGURATION READY message if the SHCCH messages for this radio link will be transmitted over a different secondary CCPCH than selected by the UE from system information.]
- [TDD – if the *TNL QoS* IE is included and if ALCAP is not used, the DRNS may use the *TNL QoS* IE to determine the transport bearer characteristics to apply for the related USCHs.]
- [TDD - The DRNC shall include in the RADIO LINK RECONFIGURATION READY message both the *Transport Layer Address* IE and the *Binding ID* IE for any new transport bearer to be established for each modified USCH.]

#### **RL Information:**

[FDD - If the *RL Information* IE includes the *DL DPCH Timing Adjustment* IE, the DRNS shall adjust the timing of the radio link accordingly in the new configuration. [If the UE Context is configured to use F-DPCH in the downlink in the new configuration, the DRNC may include the DL Code Information IE in the RADIO LINK RECONFIGURATION READY message.](#)]

#### **HS-DSCH Setup:**

If the *HS-DSCH Information* IE is present in the RADIO LINK RECONFIGURATION PREPARE message, then:

- The DRNS shall setup the requested HS-PDSCH resources on the Serving HS-DSCH Radio Link indicated by the *HS-PDSCH RL ID* IE.
- The DRNC shall include the *HARQ Memory Partitioning* IE in the [FDD – *HS-DSCH FDD Information Response* IE] [TDD – *HS-DSCH TDD Information Response* IE] in the RADIO LINK RECONFIGURATION READY message.
- The DRNC shall allocate an HS-DSCH-RNTI to the UE Context and include the *HS-DSCH-RNTI* IE in the RADIO LINK RECONFIGURATION READY message.
- The DRNS may use the *Traffic Class* IE for a specific HS-DSCH MAC-d flow to determine the transport bearer characteristics to apply between DRNC and Node B.
- If the RADIO LINK RECONFIGURATION PREPARE message includes the *MAC-hs Guaranteed Bit Rate* IE for a Priority Queue in the *HS-DSCH MAC-d Flows Information* IE in the *HS-DSCH Information* IE, then the DRNS shall use this information to optimise MAC-hs scheduling decisions for the related HSDPA Priority Queue.
- If the RADIO LINK RECONFIGURATION PREPARE message includes the *Discard Timer* IE for a Priority Queue in the *HS-DSCH MAC-d Flows Information* IE in the *HS-DSCH Information* IE, then the DRNS shall use this information to discard out-of-date MAC-hs SDUs from the related HSDPA Priority Queue.

- The DRNC shall include the *HS-DSCH Initial Capacity Allocation IE* in the [FDD – *HS-DSCH FDD Information Response IE*] [TDD – *HS-DSCH TDD Information Response IE*] in the RADIO LINK RECONFIGURATION READY message for every HS-DSCH MAC-d flow being established, if the DRNS allows the SRNC to start transmission of MAC-d PDUs before the DRNS has allocated capacity on user plane as described in [32].
- [FDD - If the RADIO LINK RECONFIGURATION PREPARE message includes the *HS-SCCH Power Offset IE* in the *HS-DSCH Information IE*, then the DRNS may use this value to determine the HS-SCCH power. The HS-SCCH Power Offset should be applied for any HS-SCCH transmission to this UE.]
- [FDD - The DRNC shall include the *Measurement Power Offset IE* in the *HS-DSCH Information Response IE* in the RADIO LINK RECONFIGURATION READY message.]
- [FDD - The DRNS shall allocate HS-SCCH codes corresponding to the HS-DSCH and the DRNC shall include the *HS-SCCH Specific Information Response IE* in the *HS-DSCH FDD Information Response IE* in the RADIO LINK RECONFIGURATION READY message.]
- [TDD - The DRNS shall allocate HS-SCCH parameters corresponding to the HS-DSCH and the DRNC shall include the [3.84Mcps TDD - *HS-SCCH Specific Information Response IE*] [1.28Mcps TDD - *HS-SCCH Specific Information Response LCR IE*] in the *HS-DSCH TDD Information Response IE* in the RADIO LINK RECONFIGURATION READY message.]
- [FDD - The DRNC shall include the *HS-PDSCH And HS-SCCH Scrambling Code IE* in the *HS-DSCH FDD Information Response IE* in the RADIO LINK RECONFIGURATION READY message.]
- [FDD – If the RADIO LINK RECONFIGURATION PREPARE message includes the *HARQ Preamble Mode IE* in the *HS-DSCH Information IE*, then the DRNS shall use the indicated HARQ Preamble Mode as described in [10].]

#### **Intra-DRNS Serving HS-DSCH Radio Link Change:**

If the RADIO LINK RECONFIGURATION PREPARE message includes the *HS-PDSCH RL ID IE*, this indicates the new Serving HS-DSCH Radio Link:

- The DRNS shall release the HS-PDSCH resources on the old Serving HS-DSCH Radio Link and setup the HS-PDSCH resources on the new Serving HS-DSCH Radio Link.
- The DRNC may include the *HARQ Memory Partitioning IE* in the [FDD – *HS-DSCH FDD Information Response IE*] [TDD – *HS-DSCH TDD Information Response IE*] in the RADIO LINK RECONFIGURATION READY message.
- The DRNC shall allocate a new HS-DSCH-RNTI to the UE Context and include the *HS-DSCH-RNTI IE* in the RADIO LINK RECONFIGURATION READY message.
- If a reset of the MAC-hs is not required the DRNS shall include the *MAC-hs Reset Indicator IE* in the RADIO LINK RECONFIGURATION READY message.
- [FDD - The DRNC shall include the *Measurement Power Offset IE* in the *HS-DSCH Information Response IE* in the RADIO LINK RECONFIGURATION READY message.]
- [FDD - The DRNS shall allocate HS-SCCH codes corresponding to the HS-DSCH and the DRNC shall include the *HS-SCCH Specific Information Response IE* in the *HS-DSCH FDD Information Response IE* in the RADIO LINK RECONFIGURATION READY message.]
- [TDD - The DRNS shall allocate HS-SCCH parameters corresponding to the HS-DSCH and the DRNC shall include the [3.84Mcps TDD - *HS-SCCH Specific Information Response IE*] [1.28Mcps TDD - *HS-SCCH Specific Information Response LCR IE*] in the *HS-DSCH TDD Information Response IE* in the RADIO LINK RECONFIGURATION READY message.]
- [TDD - The DRNC shall include the [3.84 Mcps TDD - *HS-PDSCH Timeslot Specific Information IE*] [1.28 Mcps TDD - *HS-PDSCH Timeslot Specific Information LCR IE*] in the *HS-DSCH Information Response IE* in the RADIO LINK SETUP RESPONSE message.]
- [FDD - The DRNC shall include the *HS-PDSCH And HS-SCCH Scrambling Code IE* in the *HS-DSCH FDD Information Response IE* in the RADIO LINK RECONFIGURATION READY message.]

**HS-DSCH Modification:**

If the RADIO LINK RECONFIGURATION PREPARE message includes the *HS-DSCH Information To Modify* IE, then:

- The DRNC shall include the *HS-DSCH Initial Capacity Allocation* IE for each HS-DSCH MAC-d flow being modified for which a new transport bearer was requested with the *Transport Bearer Request Indicator* IE, if the DRNS allows the SRNC to start transmission of MAC-d PDUs before the DRNS has allocated capacity on user plane as described in [32].
- If the RADIO LINK RECONFIGURATION PREPARE message includes the *Traffic Class* IE in the *HS-DSCH Information To Modify* IE for a specific HS-DSCH MAC-d flow, the DRNS may use this information to determine the transport bearer characteristics to apply between DRNC and Node B.
- If the RADIO LINK RECONFIGURATION PREPARE message includes the *MAC-hs Guaranteed Bit Rate* IE in the *HS-DSCH Information To Modify* IE, the DRNS shall use this information to optimise MAC-hs scheduling decisions for the related HSDPA Priority Queue.
- If the RADIO LINK RECONFIGURATION PREPARE message includes the *Discard Timer* IE in the *HS-DSCH Information* IE, then the DRNS shall use this information to discard out-of-date MAC-hs SDUs from the related HSDPA Priority Queue.
- If the RADIO LINK RECONFIGURATION PREPARE message includes the *MAC-hs Window Size* IE or *TI* IE in the *HS-DSCH Information To Modify* IE, then the DRNS shall use the indicated values in the new configuration for the related HSDPA Priority Queue.
- If the RADIO LINK RECONFIGURATION PREPARE message includes the *MAC-d PDU Size Index* IE in the *Modify Priority Queue* choice, the DRNS shall delete the previous list of MAC-d PDU Size Index values for the related HSDPA Priority Queue and use the MAC-d PDU Size Index values indicated in the *MAC-d PDU Size Index* IE in the new configuration.
- [FDD - If the RADIO LINK RECONFIGURATION PREPARE message includes the *CQI Feedback Cycle k* IE, the *CQI Repetition Factor* IE, the *ACK-NACK Repetition Factor* IE, the *ACK Power Offset* IE, the *NACK Power Offset* IE or the *CQI Power Offset* IE in the *HS-DSCH Information To Modify* IE, then the DRNS shall use the indicated CQI Feedback Cycle k value, the CQI Repetition Factor or the ACK-NACK Repetition Factor, ACK Power Offset, the NACK Power Offset or the CQI Power Offset in the new configuration.]
- [FDD - If the *HS-SCCH Power Offset* IE is included in the *HS-DSCH Information To Modify* IE, the DRNS may use this value to determine the HS-SCCH power. The HS-SCCH Power Offset should be applied for any HS-SCCH transmission to this UE.]
- [TDD – If the RADIO LINK RECONFIGURATION PREPARE message includes the *TDD ACK NACK Power Offset* IE in the *HS-DSCH Information To Modify* IE, the DRNS shall use the indicated power offset in the new configuration.]
- [FDD - If the *HS-DSCH Information To Modify* IE includes the *HS-SCCH Code Change Grant* IE, then the DRNS may modify the HS-SCCH codes corresponding to the HS-DSCH. The DRNC shall then report the codes which are used in the new configuration specified in the *HS-SCCH Specific Information Response* IE in the RADIO LINK RECONFIGURATION READY message.]
- [TDD - If the *HS-DSCH Information To Modify* IE includes the *HS-SCCH Code Change Grant* IE, then the DRNS may modify the HS-SCCH parameters corresponding to the HS-DSCH. The DRNC shall then report the values for the parameters which are used in the new configuration specified in the [3.84Mcps TDD - *HS-SCCH Specific Information Response* IE] [1.28Mcps TDD - *HS-SCCH Specific Information Response LCR* IE] in the RADIO LINK RECONFIGURATION READY message.]
- [FDD – If the RADIO LINK RECONFIGURATION PREPARE message includes the *HARQ Preamble Mode* IE in the *HS-DSCH Information To Modify* IE, then the Node B shall use the indicated HARQ Preamble Mode in the new configuration as described in [10].]

**HS-DSCH MAC-d Flow Addition/Deletion:**

If the RADIO LINK RECONFIGURATION PREPARE message includes any *HS-DSCH MAC-d Flows To Add* or *HS-DSCH MAC-d Flows To Delete* IEs, then the DRNS shall use this information to add/delete the indicated HS-DSCH



MAC-d flows on the Serving HS-DSCH Radio Link. When an HS-DSCH MAC-d flow is deleted, all its associated Priority Queues shall also be removed.

If the RADIO LINK RECONFIGURATION PREPARE message includes an *HS-DSCH MAC-d Flows To Delete* IE requesting the deletion of all remaining HS-DSCH MAC-d flows for the UE Context, then the DRNC shall delete the HS-DSCH configuration from the UE Context and release the HS-PDSCH resources.

If the RADIO LINK RECONFIGURATION PREPARE message includes the *HS-DSCH MAC-d Flows To Add* IE, then:

- The DRNS may use the *Traffic Class* IE for a specific HS-DSCH MAC-d flow to determine the transport bearer characteristics to apply between DRNC and Node B.
- The DRNC shall include the *HS-DSH Initial Capacity Allocation* IE in the RADIO LINK RECONFIGURATION READY message for every HS-DSCH MAC-d flow being added, if the DRNS allows the SRNC to start transmission of MAC-d PDUs before the DRNS has allocated capacity on user plane as described in [32].
- If the RADIO LINK RECONFIGURATION PREPARE message includes the *MAC-hs Guaranteed Bit Rate* IE in the *HS-DSCH MAC-d Flows To Add* IE, the DRNS shall use this information to optimise MAC-hs scheduling decisions for the related HSDPA Priority Queue.
- If the RADIO LINK RECONFIGURATION PREPARE message includes the *Discard Timer* IE in the *HS-DSCH Information* IE, then the DRNS shall use this information to discard out-of-date MAC-hs SDUs from the related HSDPA Priority Queue.
- The DRNC may include the *HARQ Memory Partitioning* IE in the RADIO LINK RECONFIGURATION READY message.

#### **E-DCH Setup:**

If the *E-DCH FDD Information* IE is present in the RADIO LINK RECONFIGURATION PREPARE message and the *RL Information* IE contains the *RL specific E-DCH Information* IE for one Radio Link then:

- The DRNS shall setup the requested E-DCH resources on the Radio Link indicated by the *RL ID* IE in the *RL Information* IE.
- The RADIO LINK RECONFIGURATION PREPARE message shall contain in the *RL Information* IE for every RL the *E-DCH RL Indication* IE indicates whether this RL has configured E-DCH resources.
- If the RADIO LINK RECONFIGURATION PREPARE message includes the *MAC-e Guaranteed Bit Rate* IE for an E-DCH MAC-d flow in the *E-DCH FDD Information* IE, then the DRNS shall use this information to optimise MAC-e scheduling decisions.
- If the RADIO LINK RECONFIGURATION PREPARE message includes the *Maximum Number of Retransmissions for E-DCH* IE for a E-DCH MAC-d flow in the *E-DCH FDD Information* IE, then the DRNS shall use this information to report if the maximum number of retransmissions has been exceeded.
- The DRNS may use the *Traffic Class* IE for a specific E-DCH MAC-d flow to determine the transport bearer characteristics to apply between DRNC and Node B.
- If the *TNL QoS* IE is included for a E-DCH MAC-d flow and if ALCAP is not used, the *TNL QoS* IE may be used by the DRNS to determine the transport bearer characteristics to apply in the uplink for the related MAC-d flow.
- The DRNC shall include the *E-AGCH and E-RGCH and E-HICH FDD Scrambling Code* IE and the *E-RGCH and E-HICH Channelisation Code* IE and the corresponding Sequence number for *E-RGCH* IE and the Sequence number for *E-HICH* IE in the *E-DCH FDD DL Control Channel Information* IE in the RADIO LINK RECONFIGURATION READY message.

If the RADIO LINK RECONFIGURATION PREPARE message contains the *Serving E-DCH RL ID* IE the DRNC shall allocate an E-RNTI and include this E-RNTI and the Channelisation Code of the corresponding E-AGCH in the *E-DCH FDD DL Control Channel Information* IE in the *RL Information* IE for the indicated RL in the RADIO LINK RECONFIGURATION READY message.]

#### **E-DCH Modification:**

If the RADIO LINK RECONFIGURATION PREPARE message includes the *E-DCH FDD Information To Modify* IE, then:

- If the *E-DCH MAC-d Flow Information* IE includes the *Payload CRC Presence Indicator* IE the DRNS shall apply the payload indicator in the Uplink of the user plane for the E-DCH in the new configuration.
- If the *E-DCH FDD Information To Modify* IE contains a *E-DCH MAC-d Flow Information* IE which includes the *Allocation/Retention Priority* IE, the DRNS shall apply the new Allocation/Retention Priority to this E-DCH in the new configuration according to Annex A.
- If the *TNL QoS* IE is included for a E-DCH MAC-d flow and if ALCAP is not used, the *TNL QoS* IE may be used by the DRNS to determine the transport bearer characteristics to apply in the uplink for the related MAC-d flow.
- If the RADIO LINK RECONFIGURATION PREPARE message includes the *Data Description Indicator* IE, the DRNC shall use the DDI values indicated in the *Data Description Indicator* IE in the new configuration.
- If the RADIO LINK RECONFIGURATION PREPARE message includes the *MAC-e Guaranteed Bit Rate* IE in the *E-DCH FDD Information To Modify* IE, the DRNS shall use this information to optimise MAC-e scheduling decisions.
- If the RADIO LINK RECONFIGURATION PREPARE message includes the *Maximum Number of Retransmissions for E-DCH* IE for a E-DCH MAC-d flow in the *E-DCH FDD Information To Modify* IE, then the DRNS shall use this information to report if the maximum number of retransmissions has been exceeded.
- The DRNC shall include the *E-AGCH and E-RGCH and E-HICH FDD Scrambling Code* IE and the *E-RGCH and E-HICH Channelisation Code* IE and the corresponding *Sequence number* IE in the *E-DCH FDD DL Control Channel Information* IE in the RADIO LINK RECONFIGURATION READY message.

If the RL Information IE contains the *Serving E-DCH RL ID* IE for one RL then the DRNC shall allocate an E-RNTI and include this E-RNTI and the Channelisation Code of the corresponding E-AGCH in the *E-DCH FDD DL Control Channel Information* IE in the *RL Information* IE for the indicated RL in the RADIO LINK RECONFIGURATION READY message.]

#### **E-DCH MAC-d Flow Addition/Deletion:**

If the RADIO LINK RECONFIGURATION PREPARE message includes any *E-DCH MAC-d Flows To Add* or *E-DCH MAC-d Flows To Delete* IEs in the *RL Information* IE, then the DRNS shall use this information to add/delete the indicated E-DCH MAC-d flows on the Serving E-DCH Radio Link. When an E-DCH MAC-d flow is deleted, all its associated Priority Queues shall also be removed.

If the RADIO LINK RECONFIGURATION PREPARE message includes an *E-DCH MAC-d Flows To Delete* IE requesting the deletion of all remaining E-DCH MAC-d flows for the UE Context, then the DRNC shall delete the E-DCH configuration from the UE Context and release the E-DCH resources.

If the RADIO LINK RECONFIGURATION PREPARE message includes the *E-DCH MAC-d Flows To Add* IE, then:

- The DRNS may use the *Traffic Class* IE for a specific E-DCH MAC-d flow to determine the transport bearer characteristics to apply between DRNC and Node B.
- If the RADIO LINK RECONFIGURATION PREPARE message includes the *MAC-e Guaranteed Bit Rate* IE in the *E-DCH MAC-d Flows To Add* IE, the DRNS shall use this information to optimise MAC-e scheduling decisions.

#### **[1.28Mcps TDD - Uplink Synchronisation Parameters LCR]:**

[1.28Mcps TDD -If the *Uplink Synchronisation Parameters LCR* IE is present, the DRNC shall use the indicated values of *Uplink synchronisation stepsize* IE and *Uplink synchronisation frequency* IE when evaluating the timing of the UL synchronisation.]

#### **[1.28Mcps TDD - Uplink Timing Advance Control LCR]:**

[1.28Mcps TDD - The DRNC shall include the *Uplink Timing Advance Control LCR* IE in the RADIO LINK RECONFIGURATION READY message, if the Uplink Timing Advance Control parameters have been changed.]

#### **[TDD] DSCH RNTI Addition/Deletion**

[TDD - If the RADIO LINK RECONFIGURATION PREPARE message includes the PDSCH RL ID IE, then the DRNS shall use it as the new RL identifier for PDSCH and PUSCH.]

- [TDD - If the indicated PDSCH RL ID is in the DRNS and there was no DSCH-RNTI allocated to the UE Context, the DRNC shall allocate a DSCH-RNTI to the UE Context and include the DSCH-RNTI IE in the RADIO LINK RECONFIGURATION READY message.]
- [TDD - If the indicated PDSCH RL ID is in the DRNS and there was a DSCH-RNTI allocated to the UE Context, the DRNC shall allocate a new DSCH-RNTI to the UE Context, release the old DSCH-RNTI and include the DSCH-RNTI IE in the RADIO LINK RECONFIGURATION READY message.]
- [TDD - If the indicated PDSCH RL ID is not in the DRNS and there was a DSCH-RNTI allocated to the UE Context, the DRNC shall release this DSCH-RNTI.]

[TDD - If the RADIO LINK RECONFIGURATION PREPARE message includes a DSCHs to Delete IE and/or a USCHs to Delete IE which results in the deletion of all DSCH and USCH resources for the UE Context, then the DRNC shall release the DSCH-RNTI allocated to the UE Context, if there was one.]

#### **[FDD – Phase Reference Handling]:**

[FDD – If the RADIO LINK RECONFIGURATION PREPARE message includes the *UE Support Of Dedicated Pilots For Channel Estimation* IE, the DRNC shall assume that dedicated pilots may be used for channel estimation for DCH or DSCH.]

[FDD – If the RADIO LINK RECONFIGURATION PREPARE message includes the *UE Support Of Dedicated Pilots For Channel Estimation Of HS-DSCH* IE, the DRNC shall assume that dedicated pilots may be used for channel estimation for HS-DSCH.]

[FDD – If Primary CPICH usage for channel estimation information has been reconfigured, the DRNC shall include the *Primary CPICH Usage For Channel Estimation* IE in the RADIO LINK RECONFIGURATION READY message.]

[FDD – If Secondary CPICH information for channel estimation has been reconfigured, the DRNC shall include the *Secondary CPICH Information Change* IE in the RADIO LINK RECONFIGURATION READY message.]

[FDD – If the RADIO LINK RECONFIGURATION PREPARE message includes *Phase Reference Update Indicator* IE, DRNC shall modify the channel estimation information according to [10] subclause 4.3.2.1 and set the value(s) in *Primary CPICH Usage For Channel Estimation* IE and/or *Secondary CPICH Information Change* IE in the RADIO LINK RECONFIGURATION READY message accordingly.]

#### **General**

If the requested modifications are allowed by the DRNC and the DRNC has successfully reserved the required resources for the new configuration of the Radio Link(s), it shall respond to the SRNC with the RADIO LINK RECONFIGURATION READY message. When this procedure has been completed successfully there exists a Prepared Reconfiguration, as defined in subclause 3.1.

If the RADIO LINK RECONFIGURATION PREPARE message includes the *Transport Layer Address* IE and *Binding ID* IE in the *DSCHs To Modify* IE, *DSCHs To Add* IE, [TDD - *USCHs To Modify* IE, *USCHs To Add* IE], *HS-DSCH Information* IE, *HS-DSCH Information To Modify* IE, *HS-DSCH MAC-d Flows To Add* IE, *E-DCH MAC-d Flows to Add*, or in the *RL Specific DCH Information* IEs, the DRNC may use the transport layer address and the binding identifier received from the SRNC when establishing a transport bearer for any Transport Channel, HS-DSCH MAC-d flow or E-DCH MAC-d flow being added, or any Transport Channel, HS-DSCH MAC-d flow or E-DCH MAC-d flow being modified for which a new transport bearer was requested with the *Transport Bearer Request Indicator* IE.

The DRNC shall include in the RADIO LINK RECONFIGURATION READY message the *Transport Layer Address* IE and the *Binding ID* IE for any Transport Channel, HS-DSCH MAC-d flow or E-DCH MAC-d flow being added, or any Transport Channel, HS-DSCH MAC-d flow or E-DCH MAC-d flow being modified for which a new transport bearer was requested with the *Transport Bearer Request Indicator* IE. In the case of a set of co-ordinated DCHs requiring a new transport bearer on the Iur interface, the *Transport Layer Address* IE and the *Binding ID* IE in the *DCH Information Response* IE shall be included for only one of the DCHs in the set of co-ordinated DCHs.

In the case of a Radio Link being combined with another Radio Link within the DRNS, the *Transport Layer Address* IE and the *Binding ID* IE in the *DCH Information Response* IE shall be included for only one of the combined Radio Links.

Any allowed rate for the uplink of a modified DCH provided for the old configuration will not be valid for the new configuration. If the DRNS needs to limit the user rate in the uplink of a DCH due to congestion caused by the UL UTRAN Dynamic Resources (see subclause 9.2.1.79) in the new configuration for a Radio Link, the DRNC shall include in the RADIO LINK RECONFIGURATION READY message the *Allowed UL Rate IE* in the *DCH Information Response IE* for this Radio Link.

Any allowed rate for the downlink of a modified DCH provided for the old configuration will not be valid for the new configuration. If the DRNS needs to limit the user rate in the downlink of a DCH due to congestion caused by the DL UTRAN Dynamic Resources (see subclause 9.2.1.79) in the new configuration for a Radio Link, the DRNC shall include in the RADIO LINK RECONFIGURATION READY message the *Allowed DL Rate IE* in the *DCH Information Response IE* for this Radio Link.

The DRNS decides the maximum and minimum SIR for the uplink of the Radio Link(s) and the DRNC shall include in the RADIO LINK RECONFIGURATION READY message the *Maximum Uplink SIR IE* and *Minimum Uplink SIR IE* for each Radio Link when these values are changed.

[FDD - If the DL TX power upper or lower limit has been re-configured, the DRNC shall include in the RADIO LINK RECONFIGURATION READY message the *Maximum DL TX Power IE* and *Minimum DL TX Power IE* respectively. The DRNS shall not transmit with a higher power than indicated by the *Maximum DL TX Power IE* or lower than indicated by the *Minimum DL TX Power IE* on any DL DPCH or on the F-DPCH of the RL -except, if the UE Context is configured to use DPCH in the downlink, during compressed mode, when the  $\delta P_{curr}$ , as described in ref.[10] subclause 5.2.1.3, shall be added to the maximum DL power for the associated compressed frame.]

[3.84 Mcps TDD - If the DL TX power upper or lower limit has been re-configured, the DRNC shall include the new value(s) in the *Maximum DL TX Power IE* and *Minimum DL TX Power IE* in the RADIO LINK RECONFIGURATION READY message. If the maximum or minimum power needs to be different for particular DCH type CCTrCHs, the DRNC shall include the new value(s) for that CCTrCH in the *CCTrCH Maximum DL TX Power IE* and *CCTrCH Minimum DL TX Power*. The DRNS shall not transmit with a higher power than indicated by the appropriate *Maximum DL TX Power IE/CCTrCH Maximum DL TX Power IE* or lower than indicated by the appropriate *Minimum DL TX Power IE/CCTrCH Minimum DL TX Power IE* on any DL DPCH within each CCTrCH of the RL.]

[1.28 Mcps TDD - If the DL TX power upper or lower limit has been re-configured, the DRNC shall include the new value(s) in the *Maximum DL TX Power IE* and *Minimum DL TX Power IE* in the RADIO LINK RECONFIGURATION READY message. If the maximum or minimum power needs to be different for particular timeslots within a DCH type CCTrCH, the DRNC shall include the new value(s) for that timeslot in the *Maximum DL TX Power IE* and *Minimum DL TX Power* within the *DL Timeslot Information LCR IE*. The DRNS shall not transmit with a higher power than indicated by the appropriate *Maximum DL TX Power IE* or lower than indicated by the appropriate *Minimum DL TX Power IE* on any DL DPCH within each timeslot of the RL.]

[TDD - If the [3.84Mcps TDD - *DL Time Slot ISCP Info IE*][1.28Mcps TDD - *DL Time Slot ISCP Info LCR IE*] is present, the DRNS should use the indicated values when deciding the Initial DL TX Power.]

[TDD - If the *Primary CCPCH RSCP Delta IE* is included, the DRNS shall assume that the reported value for Primary CCPCH RSCP is in the negative range as per [24], and the value is equal to the *Primary CCPCH RSCP Delta IE*. If the *Primary CCPCH RSCP Delta IE* is not included and the *Primary CCPCH RSCP IE* is included, the DRNS shall assume that the reported value is in the non-negative range as per [24], and the value is equal to the *Primary CCPCH RSCP IE*. The DRNS shall use the indicated values when deciding the Initial DL TX Power.]

### 8.3.4.3 Unsuccessful Operation

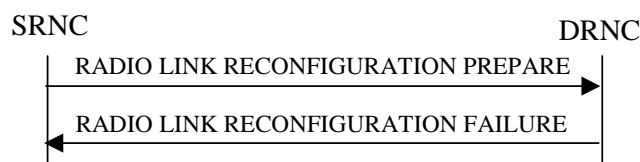

**Figure 11: Synchronised Radio Link Reconfiguration Preparation procedure, Unsuccessful Operation**

If the DRNS cannot reserve the necessary resources for all the new DCHs of a set of co-ordinated DCHs requested to be added, it shall reject the Synchronised Radio Link Reconfiguration Preparation procedure as having failed.

If the requested Synchronised Radio Link Reconfiguration Preparation procedure fails for one or more RLs, the DRNC shall send the RADIO LINK RECONFIGURATION FAILURE message to the SRNC, indicating the reason for failure for each failed radio link in a *Cause IE*.

Typical cause values are:

**Radio Network Layer Causes:**

- UL Scrambling Code Already in Use;
- DL Radio Resources not Available;
- UL Radio Resources not Available;
- Requested Configuration not Supported;
- Number of DL Codes not Supported;
- Number of UL Codes not Supported;
- Dedicated Transport Channel Type not Supported;
- DL Shared Channel Type not Supported;
- [TDD - UL Shared Channel Type not Supported];
- [FDD - UL Spreading Factor not Supported];
- [FDD - DL Spreading Factor not Supported];
- CM not Supported;
- RL Timing Adjustment not Supported;
- [FDD - HARQ Preamble Mode not supported].
- [F-DPCH not supported.](#)

**Miscellaneous Causes:**

- Control Processing Overload;
- Not enough User Plane Processing Resources.

#### 8.3.4.4 Abnormal Conditions

If only a subset of all the DCHs belonging to a set of co-ordinated DCHs is requested to be deleted, the DRNS shall reject the Synchronised Radio Link Reconfiguration Preparation procedure as having failed and shall send the RADIO LINK RECONFIGURATION FAILURE message to the SRNC.

If more than one DCH of a set of co-ordinated DCHs has the *QE-Selector IE* set to "selected" [TDD - or no DCH of a set of co-ordinated DCHs has the *QE-Selector IE* set to "selected"] the DRNS shall reject the Synchronised Radio Link Reconfiguration Preparation procedure and the DRNC shall respond with a RADIO LINK RECONFIGURATION FAILURE message.

[FDD - If the *RL Information IE* includes the *SSDT Indication IE* set to "SSDT Active in the UE" and SSDT is not active in the current configuration, the DRNS shall reject the Synchronised Radio Link Reconfiguration Preparation procedure if the *UL DPCH Information IE* does not include the *SSDT Cell Identity Length IE*. The DRNC shall then respond with a RADIO LINK RECONFIGURATION FAILURE message.]

[FDD - If the *DSCHs To Add IE* includes the *Enhanced DSCH PC IE* and the *DSCH To Modify IE* include the *Enhanced DSCH PC Indicator IE* set to "Enhanced DSCH PC not Active in the UE", then the DRNS shall deactivate enhanced DSCH power control in the new configuration.]

[FDD - If both the *DSCHs To Add IE* and the *DSCH To Modify IE* include *Enhanced DSCH PC IE*, then the DRNS shall ignore the *Enhanced DSCH PC IE* in the *DSCH To Add IE*.]

If the RADIO LINK RECONFIGURATION PREPARE message includes a *DCHs To Modify* IE or *DCHs To Add* IE with multiple *DCH Specific Info* IEs, and if the DCHs in the *DCHs To Modify* IE or *DCHs To Add* IE do not have the same *Transmission Time Interval* IE in the *Semi-static Transport Format Information* IE, then the DRNC shall reject the procedure using the RADIO LINK RECONFIGURATION FAILURE message.

[FDD - If the *RL Information* IE includes the *DL Reference Power* IE, but the power balancing is not active in the indicated RL(s), the DRNS shall reject the Synchronised Radio Link Reconfiguration Preparation procedure as having failed and the DRNC shall respond with the RADIO LINK RECONFIGURATION FAILURE message with the cause value "Power Balancing status not compatible".]

[FDD - If the power balancing is active with the Power Balancing Adjustment Type of the UE Context set to "Common" in the existing RL(s) but the RADIO LINK RECONFIGURATION PREPARE message includes more than one *DL Reference Power* IE, the DRNS shall reject the Synchronised Radio Link Reconfiguration Preparation procedure as having failed and the DRNC shall respond with the RADIO LINK RECONFIGURATION FAILURE message with the cause value "Power Balancing status not compatible".]

[FDD - If the RADIO LINK RECONFIGURATION PREPARE message does not include the *Split Type* IE but includes *TFCI Signalling Mode* IE set to "Split", then the DRNC shall reject the procedure using the RADIO LINK RECONFIGURATION FAILURE message.]

[FDD - If the RADIO LINK RECONFIGURATION PREPARE message does not include the *Length of TFCI2* IE but the *Split type* IE is set to "Logical", then the DRNC shall reject the procedure using the RADIO LINK RECONFIGURATION FAILURE message.]

[FDD - If the RADIO LINK RECONFIGURATION PREPARE message includes the *Split Type* IE set to the value "Hard" and the *Length Of TFCI2* IE set to the value "1", "2", "5", "8", "9" or "10", then the DRNC shall reject the procedure using the RADIO LINK RECONFIGURATION FAILURE message.]

[FDD - If the RADIO LINK RECONFIGURATION PREPARE message does not include the *Split Type* IE but includes the *Length of TFCI2* IE, then the DRNC shall reject the procedure using the RADIO LINK RECONFIGURATION FAILURE message.]

If the RADIO LINK RECONFIGURATION PREPARE message contains the *Transport Layer Address* IE or the *Binding ID* IE when establishing a transport bearer for any Transport Channel or HS-DSCH MAC-d flow being added, or any Transport Channel or HS-DSCH MAC-d flow being modified for which a new transport bearer was requested with the *Transport Bearer Request Indicator* IE., and not both are present for a transport bearer intended to be established, the DRNC shall reject the Synchronised Radio Link Reconfiguration Preparation procedure and the DRNC shall respond with a RADIO LINK RECONFIGURATION FAILURE message.

If the RADIO LINK RECONFIGURATION PREPARE message contains any of the *HS-DSCH Information To Modify* IE, *HS-DSCH MAC-d Flows To Add* IE or *HS-DSCH MAC-d Flows To Delete* IE in addition to the *HS-DSCH Information* IE, the DRNC shall reject the procedure using the RADIO LINK RECONFIGURATION FAILURE message.

If the RADIO LINK RECONFIGURATION PREPARE message contains any of the *HS-DSCH Information To Modify* IE, *HS-DSCH MAC-d Flows To Add* IE, *HS-DSCH MAC-d Flows To Delete* IE or *HS-PDSCH RL ID* IE and the Serving HS-DSCH Radio Link is not in the DRNS, the DRNC shall reject the procedure using the RADIO LINK RECONFIGURATION FAILURE message.

If the RADIO LINK RECONFIGURATION PREPARE message includes the *HS-DSCH Information* IE and does not include the *HS-PDSCH RL-ID* IE, the DRNC shall reject the procedure using the RADIO LINK RECONFIGURATION FAILURE message.

If the RADIO LINK RECONFIGURATION PREPARE message includes the *HS-DSCH Information To Modify* IE deleting the last remaining Priority Queue of an HS-DSCH MAC-d Flow, the DRNC shall reject the procedure using the RADIO LINK RECONFIGURATION FAILURE message.

If the RADIO LINK RECONFIGURATION PREPARE message includes the *HS-PDSCH RL-ID* IE indicating a Radio Link not existing in the UE Context, the DRNC shall reject the procedure using the RADIO LINK RECONFIGURATION FAILURE message.

If the RADIO LINK RECONFIGURATION PREPARE message contains any of the *HS-DSCH Information* IE, *HS-DSCH Information To Modify* IE, or *HS-DSCH MAC-d Flows To Add* IE and if in the new configuration the Priority

Queues associated with the same *HS-DSCH MAC-d Flow ID* IE have the same *Scheduling Priority Indicator* IE value, the DRNC shall reject the procedure using the RADIO LINK RECONFIGURATION FAILURE message.

[FDD - If the RADIO LINK RECONFIGURATION PREPARE message includes the *F-DPCH Information IE* and the *DL DPCH Information IE*, then the DRNS shall reject the procedure using the RADIO LINK RECONFIGURATION FAILURE message.]

[FDD - If the concerned UE Context is configured to use DPCH in the downlink in the old configuration and if the RADIO LINK RECONFIGURATION PREPARE message includes the *DL DPCH Power Information IE*, then the DRNS shall reject the procedure using the RADIO LINK RECONFIGURATION FAILURE message.]

[FDD - If the concerned UE Context is configured to use F-DPCH in the downlink in the old configuration and the RADIO LINK RECONFIGURATION PREPARE message includes at least one but not all of the *TFCS IE*, *DL DPCH Slot Format IE*, *TFCI Signalling Mode IE*, *Multiplexing Position IE*, *Limited Power Increase IE* and *DL DPCH Power Information IE* in the *DL DPCH Information IE*, then the DRNS shall reject the procedure using the RADIO LINK RECONFIGURATION FAILURE message.]

## 8.3.5 Synchronised Radio Link Reconfiguration Commit

### 8.3.5.1 General

This procedure is used to order the DRNS to switch to the new configuration for the Radio Link(s) within the DRNS, previously prepared by the Synchronised Radio Link Reconfiguration Preparation procedure.

This procedure shall use the signalling bearer connection for the relevant UE Context.

### 8.3.5.2 Successful Operation



**Figure 12: Synchronised Radio Link Reconfiguration Commit procedure, Successful Operation**

The DRNS shall switch to the new configuration previously prepared by the Synchronised Radio Link Reconfiguration Preparation procedure at the next coming CFN with a value equal to the value requested by the SRNC in the *CFN* IE (see ref.[17] subclause 9.4) when receiving the RADIO LINK RECONFIGURATION COMMIT message from the SRNC.

[FDD - If the *Active Pattern Sequence Information* IE is included in the RADIO LINK RECONFIGURATION COMMIT message, the *CM Configuration Change CFN* IE in the *Active Pattern Sequence Information* IE shall be ignored by the DRNS.]

When this procedure has been completed the Prepared Reconfiguration does not exist any more, see subclause 3.1.

In the case of a transport channel modification for which a new transport bearer was requested and established, the switch to the new transport bearer shall also take place at the indicated CFN. The detailed frame protocol handling during transport bearer replacement is described in [4], subclause 5.10.1 and in [32], subclause 5.3.1.

[FDD - If the RADIO LINK RECONFIGURATION COMMIT includes the *Active Pattern Sequence Information* IE, the DRNS shall deactivate all the ongoing Transmission Gap Pattern Sequences at the *CFN* IE. From that moment on all Transmission Gap Pattern Sequences included in *Transmission Gap Pattern Sequence Status* IE repetitions shall be started when the indicated *TGCFN* IE elapses. The *CFN* IE and *TGCFN* IE for each sequence refer to the next coming CFN with that value. If the values of the *CFN* IE and the *TGCFN* IE are equal, the concerned Transmission Gap Pattern Sequence shall be started immediately at the CFN with a value equal to the value received in the *CFN* IE.]

[FDD - If the RADIO LINK RECONFIGURATION COMMIT message includes the *Active Pattern Sequence Information* IE and the concerned UE Context is configured to use F-DPCH in the downlink, the DRNS shall ignore, when activating the Transmission Gap Pattern Sequence(s), the downlink compressed mode method information, if existing, for the concerned Transmission Gap Pattern Sequence(s) in the Compressed Mode Configuration]

### 8.3.5.3 Abnormal Conditions

If a new transport bearer is required for the new configuration and it is not available at the requested CFN, the DRNS shall initiate the Radio Link Failure procedure.



## 8.3.7 Unsynchronised Radio Link Reconfiguration

### 8.3.7.1 General

The Unsynchronised Radio Link Reconfiguration procedure is used to reconfigure Radio Link(s) related to one UE-UTRAN connection within a DRNS.

The procedure is used when there is no need to synchronise the time of the switching from the old to the new radio link configuration in the cells used by the UE-UTRAN connection within the DRNS.

This procedure shall use the signalling bearer connection for the relevant UE Context.

The Unsynchronised Radio Link Reconfiguration procedure shall not be initiated if a Prepared Reconfiguration exists, as defined in subclause 3.1.

### 8.3.7.2 Successful Operation

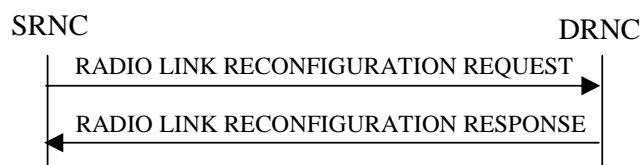

**Figure 14: Unsynchronised Radio Link Reconfiguration procedure, Successful Operation**

The Unsynchronised Radio Link Reconfiguration procedure is initiated by the SRNC by sending the RADIO LINK RECONFIGURATION REQUEST message to the DRNC.

Upon receipt, the DRNS shall modify the configuration of the Radio Link(s) according to the parameters given in the message. Unless specified below, the meaning of parameters is specified in other specifications.

If the RADIO LINK RECONFIGURATION REQUEST message includes the *Allowed Queuing Time* IE the DRNS may queue the request the time corresponding to the value of the *Allowed Queuing Time* IE before starting to execute the request.

The DRNS shall prioritise resource allocation for the RL to be modified according to Annex A.

#### **DCH Modification:**

If the RADIO LINK RECONFIGURATION REQUEST message includes any *DCHs To Modify* IEs, then the DRNS shall treat them as follows:

- If the *DCHs To Modify* IE includes multiple *DCH Specific Info* IEs, then the DRNS shall treat the DCHs as a set of co-ordinated DCHs. The DRNS shall include these DCHs in the new configuration only if it can include all of them in the new configuration.
- If the *DCHs To Modify* IE includes the *UL FP Mode* IE for a DCH or a set of co-ordinated DCHs to be modified, the DRNS shall apply the new FP Mode in the Uplink of the user plane for the DCH or the set of co-ordinated DCHs in the new configuration.
- If the *DCHs To Modify* IE includes the *ToAWS* IE for a DCH or a set of co-ordinated DCHs to be modified, the DRNS shall apply the new ToAWS in the user plane for the DCH or the set of co-ordinated DCHs in the new configuration.
- If the *DCHs To Modify* IE includes the *ToAWE* IE for a DCH or a set of co-ordinated DCHs to be modified, the DRNS shall apply the new ToAWE in the user plane for the DCH or the set of co-ordinated DCHs in the new configuration.
- If the *DCHs To Modify* IE contains a *DCH Specific Info* IE which includes a *Transport Format Set* IE for the UL of a DCH to be modified, the DRNS shall apply the new Transport Format Set in the Uplink of this DCH in the new configuration.

- If the *DCHs To Modify* IE contains a *DCH Specific Info* IE which includes a *Transport Format Set* IE for the DL of a DCH to be modified, the DRNS shall apply the new Transport Format Set in the Downlink of this DCH in the new configuration.
- If the *DCHs To Modify* IE contains a *DCH Specific Info* IE which includes the *Frame Handling Priority* IE, the DRNS should store this information for this DCH in the new configuration. The received Frame Handling Priority should be used when prioritising between different frames in the downlink on the radio interface in congestion situations within the DRNS once the new configuration has been activated.
- If the *DCH Specific Info* IE includes the *Traffic Class* IE, the DRNC may use this information to determine the transport bearer characteristics to apply between DRNC and Node B for the related DCH or set of co-ordinated DCHs. The DRNC should ignore the *Traffic Class* IE if the *TrCH Source Statistics Descriptor* IE indicates the value "RRC".
- If the *TNL QoS* IE is included for a DCH or a set of co-ordinated DCHs and if ALCAP is not used, the DRNS may use this information to determine the transport bearer characteristics to apply for the uplink for the related DCH or set of co-ordinated DCHs.
- If the *DCHs To Modify* IE contains a *DCH Specific Info* IE which includes the *Allocation/Retention Priority* IE, the DRNS shall apply the new Allocation/Retention Priority to this DCH in the new configuration according to Annex A.
- [FDD - If the *DRAC Control* IE is present and set to "requested" in *DCHs To Modify* IE for at least one DCH, and if the DRNS supports the DRAC, the DRNC shall include in the RADIO LINK RECONFIGURATION RESPONSE message the *Secondary CCPCH Info* IE for the FACH in which the DRAC information is sent, for each Radio Link supported by a cell in which DRAC is active.]
- [TDD - If the *DCHs To Modify* IE contains a *DCH Specific Info* IE which includes the *CCTrCH ID* IE for the UL, the DRNS shall map the DCH onto the referenced UL CCTrCH in the new configuration.]
- [TDD - If the *DCHs To Modify* IE contains a *DCH Specific Info* IE which includes the *CCTrCH ID* IE for the DL, the DRNS shall map the DCH onto the referenced DL CCTrCH in the new configuration.]
- If the *DCHs To Modify* IE contains a *DCH Specific Info* IE which includes the *Guaranteed Rate Information* IE, the DRNS shall treat the included IEs according to the following:
  - If the *Guaranteed Rate Information* IE includes the *Guaranteed UL Rate* IE, the DRNS shall apply the new Guaranteed Rate in the uplink of this DCH in the new configuration. The DRNS may decide to request the SRNC to limit the user rate in the uplink of the DCH at any point in time after activating the new configuration. The DRNS may request the SRNC to reduce the user rate of the uplink of the DCH below the guaranteed bit rate, however, whenever possible the DRNS should request the SRNC to reduce the user rate between the maximum bit rate and the guaranteed bit rate.
  - If the *Guaranteed Rate Information* IE includes the *Guaranteed DL Rate* IE, the DRNS shall apply the new Guaranteed Rate in the downlink of this DCH in the new configuration. The DRNS may decide to request the SRNC to limit the user in the downlink of the DCH at any point in time after activating the new configuration. The DRNS may request the SRNC to reduce the user rate of the downlink of the DCH below the guaranteed bit rate, however, whenever possible the DRNS should request the SRNC to reduce the user rate between the maximum bit rate and the guaranteed bit rate.

#### **DCH Addition:**

If the RADIO LINK RECONFIGURATION REQUEST message includes any *DCHs To Add* IEs, then the DRNS shall treat them each as follows:

- The DRNS shall reserve necessary resources for the new configuration of the Radio Link(s) according to the parameters given in the message and include these DCH in the new configuration.
- If the *DCHs To Add* IE includes multiple *DCH Specific Info* IEs then the DRNS shall treat the DCHs in the *DCHs To Add* IE as a set of co-ordinated DCHs. The DRNS shall include these DCHs in the new configuration only if all of them can be in the new configuration.
- If the *DCH Specific Info* IE includes the *Unidirectional DCH Indicator* IE set to "Uplink DCH only", the DRNS shall ignore the *Transport Format Set* IE for the downlink for this DCH. As a consequence this DCH is not included as a part of the downlink CCTrCH.

- [TDD - If the *DCH Specific Info* IE includes the *Unidirectional DCH Indicator* IE set to "Downlink DCH only", the DRNS shall ignore the *Transport Format Set* IE for the uplink for this DCH. As a consequence this DCH is not included as a part of the uplink CCTrCH.]
- [FDD - For each DCH which does not belong to a set of co-ordinated DCHs, and which includes a *QE-Selector* IE set to "selected", the DRNS shall use the Transport channel BER from that DCH for the QE in the UL data frames. If no Transport channel BER is available for the selected DCH, the DRNS shall use the Physical channel BER for the QE, ref. [4]. If the *QE-Selector* IE is set to "non-selected", the DRNS shall use the Physical channel BER for the QE in the UL data frames, ref. [4].]
- For a set of co-ordinated DCHs, the DRNS shall use the Transport channel BER from the DCH with the *QE-Selector* IE set to "selected" for the QE in the UL data frames, ref. [4]. [FDD - If no Transport channel BER is available for the selected DCH, the DRNS shall use the Physical channel BER for the QE, ref. [4]. If all DCHs have the *QE-Selector* IE set to "non-selected", the DRNS shall use the Physical channel BER for the QE, ref. [4].] [TDD - If no Transport channel BER is available for the selected DCH, the DRNS shall use 0 for the QE, ref. [4].]
- The DRNS should store the *Frame Handling Priority* IE received for a DCH to be added in the new configuration. The received Frame Handling Priority should be used when prioritising between different frames in the downlink on the Uu interface in congestion situations within the DRNS once the new configuration has been activated.
- The *Traffic Class* IE may be used to determine the transport bearer characteristics to apply between DRNC and Node B for the related DCH or set of co-ordinated DCHs. The DRNC should ignore the *Traffic Class* IE if the *TrCH Source Statistics Descriptor* IE indicates the value "RRC".
- If the *TNL QoS* IE is included for a DCH or a set of co-ordinated DCHs and if ALCAP is not used, the DRNS may use this information to determine the transport bearer characteristics to apply for the uplink for the related DCH or set of co-ordinated DCHs.
- The DRNS shall use the included *UL FP Mode* IE for a DCH or a set of co-ordinated DCHs to be added as the new FP Mode in the Uplink of the user plane for the DCH or the set of co-ordinated DCHs in the new configuration.
- The DRNS shall use the included *ToAWS* IE for a DCH or a set of co-ordinated DCHs to be added as the new Time of Arrival Window Startpoint in the user plane for the DCH or the set of co-ordinated DCHs in the new configuration.
- The DRNS shall use the included *ToAWE* IE for a DCH or a set of co-ordinated DCHs to be added as the new Time of Arrival Window Endpoint in the user plane for the DCH or the set of co-ordinated DCHs in the new configuration.
- [FDD - If the *DRAC Control* IE is set to "requested" in *DCH Specific Info* IE for at least one DCH, and if the DRNS supports the DRAC, the DRNC shall include in the RADIO LINK RECONFIGURATION RESPONSE message the *Secondary CCPCH Info* IE for the FACH in which the DRAC information is sent, for each Radio Link supported by a cell in which DRAC is active. If the DRNS does not support DRAC, the DRNC shall not provide these IEs in the RADIO LINK RECONFIGURATION RESPONSE message.]
- If the *DCH Specific Info* IE includes the *Guaranteed Rate Information* IE, the DRNS shall treat the included IEs according to the following:
  - If the *Guaranteed Rate Information* IE includes the *Guaranteed UL Rate* IE, the DRNS shall apply the new Guaranteed Rate in the uplink of this DCH in the new configuration. The DRNS may decide to request the SRNC to limit the user rate of the uplink of the DCH at any point in time after activating the new configuration. The DRNS may request the SRNC to reduce the user rate of the uplink of the DCH below the guaranteed bit rate, however, whenever possible the DRNS should request the SRNC to reduce the user rate between the maximum bit rate and the guaranteed bit rate. If the *DCH Specific Info* IE in the *DCH Information* IE does not include the *Guaranteed UL Rate* IE, the DRNS shall not limit the user rate of the uplink of the DCH.
  - If the *Guaranteed Rate Information* IE includes the *Guaranteed DL Rate* IE, the DRNS shall apply the new Guaranteed Rate in the downlink of this DCH in the new configuration. The DRNS may decide to request the SRNC to limit the user rate of the downlink of the DCH at any point in time after activating the new configuration. The DRNS may request the SRNC to reduce the user rate of the downlink of the DCH below

the guaranteed bit rate, however, whenever possible the DRNS should request the SRNC to reduce the user rate between the maximum bit rate and the guaranteed bit rate. If the *DCH Specific Info* IE in the *DCH Information* IE does not include the *Guaranteed DL Rate* IE, the DRNS shall not limit the user rate of the uplink of the DCH.

#### **DCH Deletion:**

If the RADIO LINK RECONFIGURATION REQUEST message includes any *DCHs To Delete* IEs, the DRNS shall not include the referenced DCHs in the new configuration.

If all of the DCHs belonging to a set of co-ordinated DCHs are requested to be deleted, the DRNS shall not include this set of co-ordinated DCHs in the new configuration.

#### **[FDD - Physical Channel Modification:]**

[FDD - If the RADIO LINK RECONFIGURATION REQUEST message includes an *UL DPCH Information* IE, then the DRNS shall apply the parameters to the new configuration as follows: ]

- [FDD - If the *UL DPCH Information* IE includes the *TFCS* IE for the UL, the DRNS shall apply the new TFCS in the Uplink of the new configuration.]

[FDD - If the RADIO LINK RECONFIGURATION REQUEST message includes a *DL DPCH Information* IE, then the DRNS shall apply the parameters to the new configuration as follows:]

- [FDD - If the *DL DPCH Information* IE includes the *TFCS* IE for the DL, the DRNS shall apply the new TFCS in the Downlink of the new configuration.]
- [FDD - If the *DL DPCH Information* IE includes the *TFCI Signalling Mode* IE for the DL, the DRNS shall apply the new TFCI Signalling Mode in the Downlink of the new configuration.]
- [FDD - If the *DL DPCH Information* IE includes the *Limited Power Increase* IE and the IE is set to "Used", the DRNS shall, if supported, use Limited Power Increase according to ref. [10] subclause 5.2.1 for the inner loop DL power control in the new configuration.]
- [FDD - If the *DL DPCH Information* IE includes the *Limited Power Increase* IE and the IE is set to "Not Used", the DRNS shall not use Limited Power Increase for the inner loop DL power control in the new configuration.]

[FDD - If the RADIO LINK RECONFIGURATION REQUEST message includes the *Transmission Gap Pattern Sequence Information* IE, the DRNS shall store the new information about the Transmission Gap Pattern Sequences to be used in the new Compressed Mode configuration. Any Transmission Gap Pattern Sequences already existing in the previous Compressed Mode Configuration are replaced by the new sequences once the new Compressed Mode Configuration has been activated. This new Compressed Mode Configuration shall be valid in the DRNS until the next Compressed Mode Configuration is configured in the DRNS or last Radio Link is deleted.]

[FDD - If the RADIO LINK RECONFIGURATION REQUEST message includes the *Transmission Gap Pattern Sequence Information* IE, and if the *Downlink Compressed Mode Method* in one or more Transmission Gap Pattern Sequence within the *Transmission Gap Pattern Sequence Information* IE is set to "SF/2", the DRNC shall include the *DL Code Information* IE in the RADIO LINK RECONFIGURATION RESPONSE message, without changing any of the DL Channelisation Codes or DL Scrambling Codes, indicating for each DL Channelisation Code whether the alternative scrambling code shall be used or not.]

[FDD - E-DPCH Handling: If the *E-DPCH Information* IE is included, the *UL DPDCH Indicator for E-DCH operation* IE in the *UL DPCH Information* IE shall be present as well. If the *UL DPDCH Indicator for E-DCH operation* IE is set to "UL DPDCH not present" the *Min UL Channelisation Code Length* IE, the *Puncture Limit* IE and the *TFCS* IE, within the *UL DPCH Information* IE shall be ignored.]

[FDD - If the RADIO LINK RECONFIGURATION REQUEST message includes an *E-DPCH Information* IE which contains the *E-TFCS* IE, the DRNS shall use the *E-TFCS* IE for the E-DCH when reserving resources for the uplink of the new configuration. The DRNS shall apply the new TFCS in the uplink of the new configuration.]

#### **[TDD - UL/DL CCTrCH Modification]**

[TDD - If the RADIO LINK RECONFIGURATION REQUEST message includes any *UL CCTrCH To Modify* IE or *DL CCTrCH To Modify* IE, the DRNS shall reserve necessary resources for the new configuration of the Radio Link(s) according to the parameters given in the message.]

[TDD - If the RADIO LINK RECONFIGURATION REQUEST message includes any *UL CCH Information To Modify* IEs or *DL CCH Information To Modify* IEs which contain a *TFCS* IE, the DRNS shall apply the included *TFCS* IE as the new value(s) to the referenced CCH. Otherwise the DRNS shall continue to apply the previous value(s) specified for this CCH.]

[1.28Mcps TDD - If the *UL CCH To Modify* IE includes *UL SIR Target* IE, the DRNS shall apply this value as the new configuration and use it for the UL inner loop power control according [12] and [22].]

#### [TDD - UL/DL CCH Deletion]

[TDD - If the RADIO LINK RECONFIGURATION REQUEST message includes any *UL CCH Information To Delete* IEs or *DL CCH Information To Delete* IEs, the DRNS shall not include the referenced CCH in the new configuration.]

#### DL Power Control:

[FDD - If the RADIO LINK RECONFIGURATION REQUEST message includes the *DL Reference Power Information* IE and the power balancing is active, the DRNS shall update the reference power of the power balancing in the indicated RL(s), if updating of power balancing parameters by the RADIO LINK RECONFIGURATION REQUEST message is supported, using the *DL Reference Power Information* IE in the RADIO LINK RECONFIGURATION REQUEST message. The updated reference power shall be used from the next adjustment period.]

[FDD - If updating of power balancing parameters by the RADIO LINK RECONFIGURATION REQUEST message is supported by the DRNS, the DRNC shall include the *DL Power Balancing Updated Indicator* IE in the *RL Information Response* IE for each affected RL in the RADIO LINK RECONFIGURATION RESPONSE message.]

#### [1.28Mcps TDD - Uplink Synchronisation Parameters LCR]:

[1.28Mcps TDD - If the *Uplink Synchronisation Parameters LCR* IE is present, the DRNC shall use the indicated values of *Uplink synchronisation stepsize* IE and *Uplink synchronisation frequency* IE when evaluating the timing of the UL synchronisation.]

#### [1.28Mcps TDD - Uplink Timing Advance Control LCR]:

[1.28Mcps TDD - The DRNC shall include the *Uplink Timing Advance Control LCR* IE in the RADIO LINK RECONFIGURATION RESPONSE message, if the Uplink Timing Advance Control parameters have been changed.]

#### [FDD – Phase Reference Handling]:

[FDD – If the RADIO LINK RECONFIGURATION REQUEST message includes the *UE Support Of Dedicated Pilots For Channel Estimation* IE, the DRNC shall assume that dedicated pilots may be used for channel estimation for DCH or DSCH.]

[FDD – If the RADIO LINK RECONFIGURATION REQUEST message includes the *UE Support Of Dedicated Pilots For Channel Estimation Of HS-DSCH* IE, the DRNC shall assume that dedicated pilots may be used for channel estimation for HS-DSCH.]

#### HS-DSCH Setup:

If the *HS-DSCH Information* IE is present in the RADIO LINK RECONFIGURATION REQUEST message, then:

- The DRNS shall setup the requested HS-PDSCH resources on the Serving HS-DSCH Radio Link indicated by the *HS-PDSCH RL ID* IE.
- The DRNC shall include the *HARQ Memory Partitioning* IE in the [FDD – *HS-DSCH FDD Information Response* IE] [TDD – *HS-DSCH TDD Information Response* IE] in the RADIO LINK RECONFIGURATION RESPONSE message.
- The DRNC shall allocate an HS-DSCH-RNTI to the UE Context and include the *HS-DSCH-RNTI* IE in the RADIO LINK RECONFIGURATION RESPONSE message.
- The DRNS may use the *Traffic Class* IE for a specific HS-DSCH MAC-d flow to determine the transport bearer characteristics to apply between DRNC and Node B.

- If the RADIO LINK RECONFIGURATION REQUEST message includes the *MAC-hs Guaranteed Bit Rate IE* for a Priority Queue in the *HS-DSCH MAC-d Flows Information IE* in the *HS-DSCH Information IE*, then the DRNS shall use this information to optimise MAC-hs scheduling decisions for the related HSDPA Priority Queue.
- If the RADIO LINK RECONFIGURATION REQUEST message includes the *Discard Timer IE* for a Priority Queue in the *HS-DSCH MAC-d Flows Information IE* in the *HS-DSCH Information IE*, then the DRNS shall use this information to discard out-of-date MAC-hs SDUs from the related HSDPA Priority Queue.
- The DRNC shall include the *HS-DSCH Initial Capacity Allocation IE* in the [FDD – *HS-DSCH FDD Information Response IE*] [TDD – *HS-DSCH TDD Information Response IE*] in the RADIO LINK RECONFIGURATION RESPONSE message for every HS-DSCH MAC-d flow being established, if the DRNS allows the SRNC to start transmission of MAC-d PDUs before the DRNS has allocated capacity on user plane as described in [32].
- [FDD - If the RADIO LINK RECONFIGURATION REQUEST message includes the *HS-SCCH Power Offset IE* in the *HS-DSCH Information IE*, then the DRNS may use this value to determine the HS-SCCH power. The HS-SCCH Power Offset should be applied for any HS-SCCH transmission to this UE.]
- [FDD - The DRNS shall allocate HS-SCCH codes corresponding to the HS-DSCH and the DRNC shall include the *HS-SCCH Specific Information Response IE* in the *HS-DSCH FDD Information Response IE* in the RADIO LINK RECONFIGURATION RESPONSE message.]
- [TDD - The DRNS shall allocate HS-SCCH parameters corresponding to the HS-DSCH and the DRNC shall include the [3.84Mcps TDD - *HS-SCCH Specific Information Response IE*] [1.28Mcps TDD - *HS-SCCH Specific Information Response LCR IE*] in the *HS-DSCH TDD Information Response IE* in the RADIO LINK RECONFIGURATION RESPONSE message.]
- [FDD - The DRNC shall include the *HS-PDSCH And HS-SCCH Scrambling Code IE* in the *HS-DSCH FDD Information Response IE* in the RADIO LINK RECONFIGURATION RESPONSE message.]
- [FDD – If the RADIO LINK RECONFIGURATION REQUEST message includes the *HARQ Preamble Mode IE* in the *HS-DSCH Information IE*, then the DRNS shall use the indicated HARQ Preamble Mode as described in [10].]

#### **Intra-DRNS Serving HS-DSCH Radio Link Change:**

If the RADIO LINK RECONFIGURATION REQUEST message includes the *HS-PDSCH RL ID IE*, this indicates the new Serving HS-DSCH Radio Link:

- The DRNS shall release the HS-PDSCH resources on the old Serving HS-DSCH Radio Link and setup the HS-PDSCH resources on the new Serving HS-DSCH Radio Link.
- The DRNC may include the *HARQ Memory Partitioning IE* in the [FDD – *HS-DSCH FDD Information Response IE*] [TDD – *HS-DSCH TDD Information Response IE*] in the RADIO LINK RECONFIGURATION RESPONSE message.
- The DRNC shall allocate a new HS-DSCH-RNTI to the UE Context and include the *HS-DSCH-RNTI IE* in the RADIO LINK RECONFIGURATION RESPONSE message.
- If a reset of the MAC-hs is not required the DRNS shall include the *MAC-hs Reset Indicator IE* in the RADIO LINK RECONFIGURATION RESPONSE message.
- [FDD - The DRNC shall include the *Measurement Power Offset IE* in the *HS-DSCH Information Response IE* in the RADIO LINK RECONFIGURATION RESPONSE message.]
- [FDD - The DRNS shall allocate HS-SCCH codes corresponding to the HS-DSCH and the DRNC shall include the *HS-SCCH Specific Information Response IE* in the *HS-DSCH FDD Information Response IE* in the RADIO LINK RECONFIGURATION RESPONSE message.]
- [TDD - The DRNS shall allocate HS-SCCH parameters corresponding to the HS-DSCH and the DRNC shall include the [3.84Mcps TDD - *HS-SCCH Specific Information Response IE*] [1.28Mcps TDD - *HS-SCCH Specific Information Response LCR IE*] in the *HS-DSCH TDD Information Response IE* in the RADIO LINK RECONFIGURATION RESPONSE message.]

- [TDD - The DRNC shall include the [3.84 Mcps TDD - *HS-PDSCH Timeslot Specific Information IE*] [1.28 Mcps TDD - *HS-PDSCH Timeslot Specific Information LCR IE*] in the *HS-DSCH Information Response IE* in the RADIO LINK RECONFIGURATION RESPONSE message.]
- [FDD - The DRNC shall include the *HS-PDSCH And HS-SCCH Scrambling Code IE* in the *HS-DSCH FDD Information Response IE* in the RADIO LINK RECONFIGURATION RESPONSE message.]

#### HS-DSCH Modification:

If the RADIO LINK RECONFIGURATION REQUEST message includes the *HS-DSCH Information To Modify Unsynchronised IE*, then:

- The DRNC shall include the *HS-DSCH Initial Capacity Allocation IE* for each HS-DSCH MAC-d flow being modified for which a new transport bearer was requested with the *Transport Bearer Request Indicator IE*, if the DRNS allows the SRNC to start transmission of MAC-d PDU's before the DRNS has allocated capacity on user plane as described in [32].
- If the RADIO LINK RECONFIGURATION REQUEST message includes the *Traffic Class IE* in the *HS-DSCH Information To Modify Unsynchronised IE* for a specific HS-DSCH MAC-d flow, the DRNS may use this information to determine the transport bearer characteristics to apply between DRNC and Node B.
- If the RADIO LINK RECONFIGURATION REQUEST message includes the *MAC-hs Guaranteed Bit Rate IE* in the *HS-DSCH Information To Modify Unsynchronised IE*, the DRNS shall use this information to optimise MAC-hs scheduling decisions for the related HSDPA Priority Queue.
- If the RADIO LINK RECONFIGURATION REQUEST message includes the *Discard Timer IE* in the *HS-DSCH Information IE*, then the DRNS shall use this information to discard out-of-date MAC-hs SDUs from the related HSDPA Priority Queue.
- [FDD - If the RADIO LINK RECONFIGURATION REQUEST message includes the *ACK Power Offset IE*, the *NACK Power Offset IE* or the *CQI Power Offset IE* in the *HS-DSCH Information To Modify Unsynchronised IE*, then the DRNS shall use the indicated ACK Power Offset, the NACK Power Offset or the CQI Power Offset in the new configuration.]
- [FDD - If the *HS-SCCH Power Offset IE* is included in the *HS-DSCH Information To Modify Unsynchronised IE*, the DRNS may use this value to determine the HS-SCCH power. The HS-SCCH Power Offset should be applied for any HS-SCCH transmission to this UE.]
- [TDD – If the RADIO LINK RECONFIGURATION REQUEST message includes the *TDD ACK NACK Power Offset IE* in the *HS-DSCH Information To Modify Unsynchronised IE*, the DRNS shall use the indicated power offset in the new configuration.]
- [FDD – If the RADIO LINK RECONFIGURATION REQUEST message includes the *HARQ Preamble Mode IE* in the *HS-DSCH Information To Modify Unsynchronised IE*, then the DRNS shall use the indicated HARQ Preamble Mode in the new configuration as described in [10].]

#### HS-DSCH MAC-d Flow Addition/Deletion:

If the RADIO LINK RECONFIGURATION REQUEST message includes any *HS-DSCH MAC-d Flows To Add* or *HS-DSCH MAC-d Flows To Delete* IEs, then the DRNS shall use this information to add/delete the indicated HS-DSCH MAC-d flows on the Serving HS-DSCH Radio Link. When an HS-DSCH MAC-d flow is deleted, all its associated Priority Queues shall also be removed.

If the RADIO LINK RECONFIGURATION REQUEST message includes an *HS-DSCH MAC-d Flows To Delete IE* requesting the deletion of all remaining HS-DSCH MAC-d flows for the UE Context, then the DRNC shall delete the HS-DSCH configuration from the UE Context and release the HS-PDSCH resources.

If the RADIO LINK RECONFIGURATION REQUEST message includes the *HS-DSCH MAC-d Flows To Add IE*, then:

- The DRNS may use the *Traffic Class IE* for a specific HS-DSCH MAC-d flow to determine the transport bearer characteristics to apply between DRNC and Node B.

- If the RADIO LINK RECONFIGURATION REQUEST message includes the *Traffic Class* IE in the *HS-DSCH MAC-d Flows To Add* IE for a specific HS-DSCH MAC-d flow, the DRNS may use this information to determine the transport bearer characteristics to apply between DRNC and Node B.
- The DRNC shall include the *HS-DSCH Initial Capacity Allocation* IE in the RADIO LINK RECONFIGURATION RESPONSE message for every HS-DSCH MAC-d flow being added, if the DRNS allows the SRNC to start transmission of MAC-d PDUs before the DRNS has allocated capacity on user plane as described in [32].
- If the RADIO LINK RECONFIGURATION REQUEST message includes the *MAC-hs Guaranteed Bit Rate* IE in the *HS-DSCH MAC-d Flows To Add* IE, the DRNS shall use this information to optimise MAC-hs scheduling decisions for the related HSDPA Priority Queue.

If the RADIO LINK RECONFIGURATION REQUEST message includes the *Discard Timer* IE in the *HS-DSCH Information* IE, then the DRNS shall use this information to discard out-of-date MAC-hs SDUs from the related HSDPA Priority Queue.

#### **E-DCH Setup:**

If the *E-DCH FDD Information* IE is present in the RADIO LINK RECONFIGURATION REQUEST message and the *RL Information* IE contains the *RL specific E-DCH Information* IE for one Radio Link then:

- The DRNS shall setup the requested E-DCH resources on the Radio Link indicated by the *RL ID* IE in the *RL Information* IE.
- The RADIO LINK RECONFIGURATION REQUEST message shall contain in the *RL Information* IE for every RL the *E-DCH RL Indication* IE indicates whether this RL has configured E-DCH resources.
- If the RADIO LINK RECONFIGURATION REQUEST message includes the *MAC-e Guaranteed Bit Rate* IE for an E-DCH MAC-d flow in the *E-DCH FDD Information* IE, then the DRNS shall use this information to optimise MAC-e scheduling decisions.
- If the RADIO LINK RECONFIGURATION REQUEST message includes the *Maximum Number of Retransmissions for E-DCH* IE for a E-DCH MAC-d flow in the *E-DCH FDD Information* IE, then the DRNS shall use this information to report if the maximum number of retransmissions has been exceeded.
- The DRNS may use the *Traffic Class* IE for a specific E-DCH MAC-d flow to determine the transport bearer characteristics to apply between DRNC and Node B.
- If the *TNL QoS* IE is included for a E-DCH MAC-d flow and if ALCAP is not used, the *TNL QoS* IE may be used by the DRNS to determine the transport bearer characteristics to apply in the uplink for the related MAC-d flow.
- The DRNC shall include the *E-AGCH and E-RGCH and E-HICH FDD Scrambling Code* IE and the *E-RGCH and E-HICH Channelisation Code* IE and the corresponding *Sequence number for E-RGCH* IE and the *Sequence number for E-HICH* IE in the *E-DCH FDD DL Control Channel Information* IE in the RADIO LINK RECONFIGURATION RESPONSE message.

#### **E-DCH Modification:**

If the RADIO LINK RECONFIGURATION REQUEST message includes the *E-DCH FDD Information To Modify* IE, then:

- If the *E-DCH MAC-d Flow Information* IE includes the *Payload CRC Presence Indicator* IE the DRNS shall apply the payload indicator in the Uplink of the user plane for the E-DCH in the new configuration.
- If the *E-DCH FDD Information To Modify* IE contains a *E-DCH MAC-d Flow Information* IE which includes the *Allocation/Retention Priority* IE, the DRNS shall apply the new Allocation/Retention Priority to this E-DCH in the new configuration according to Annex A.
- If the *TNL QoS* IE is included for a E-DCH MAC-d flow and if ALCAP is not used, the *TNL QoS* IE may be used by the DRNS to determine the transport bearer characteristics to apply in the uplink for the related MAC-d flow.
- If the RADIO LINK RECONFIGURATION REQUEST message includes the *Data Description Indicator* IE, the DRNC shall use the DDI values indicated in the *Data Description Indicator* IE in the new configuration.



- If the RADIO LINK RECONFIGURATION REQUEST message includes the *MAC-e Guaranteed Bit Rate IE* in the *E-DCH FDD Information To Modify IE*, the DRNS shall use this information to optimise MAC-e scheduling decisions.
- If the RADIO LINK RECONFIGURATION REQUEST message includes the *Maximum Number of Retransmissions for E-DCH IE* for a E-DCH MAC-d flow in the *E-DCH FDD Information To Modify IE*, then the DRNS shall use this information to report if the maximum number of retransmissions has been exceeded.
- The DRNC shall include the *E-AGCH and E-RGCH and E-HICH FDD Scrambling Code IE* and the *E-RGCH and E-HICH Channelisation Code IE* and the corresponding *Sequence number for E-RGCH IE* and the *Sequence number for E-HICH IE* in the *E-DCH FDD DL Control Channel Information IE* in the RADIO LINK RECONFIGURATION RESPONSE message.

#### **E-DCH MAC-d Flow Addition/Deletion:**

If the RADIO LINK RECONFIGURATION REQUEST message includes any *E-DCH MAC-d Flows To Add* or *E-DCH MAC-d Flows To Delete* IEs, then the DRNS shall use this information to add/delete the indicated E-DCH MAC-d flows on the Serving E-DCH Radio Link. When an E-DCH MAC-d flow is deleted, all its associated Priority Queues shall also be removed.

If the RADIO LINK RECONFIGURATION REQUEST message includes an *E-DCH MAC-d Flows To Delete IE* requesting the deletion of all remaining E-DCH MAC-d flows for the UE Context, then the DRNC shall delete the E-DCH configuration from the UE Context and release the E-DCH resources.

If the RADIO LINK RECONFIGURATION REQUEST message includes the *E-DCH MAC-d Flows To Add IE*, then:

- The DRNS may use the *Traffic Class IE* for a specific E-DCH MAC-d flow to determine the transport bearer characteristics to apply between DRNC and Node B.
- If the RADIO LINK RECONFIGURATION REQUEST message includes the *MAC-e Guaranteed Bit Rate IE* in the *E-DCH MAC-d Flows To Add IE*, the DRNS shall use this information to optimise MAC-e scheduling decisions.

#### **General:**

If the requested modifications are allowed by the DRNS, and if the DRNS has successfully allocated the required resources and changed to the new configuration, the DRNC shall respond to the SRNC with the RADIO LINK RECONFIGURATION RESPONSE message.

If the RADIO LINK RECONFIGURATION REQUEST message includes the *RL Specific DCH Information IE*, *HS-DSCH Information IE*, *HS-DSCH Information To Modify Unsynchronised IE*, *HS-DSCH MAC-d Flows To Add IE*, or *E-DCH MAC-d Flows to Add IE*, the DRNC may use the transport layer address and the binding identifier received from the SRNC when establishing a transport bearer for any Transport Channel, HS-DSCH MAC-d flow or E-DCH MAC-d flow being added, or any Transport Channel or HS-DSCH MAC-d flow being modified for which a new transport bearer was requested with the *Transport Bearer Request Indicator IE*.

The DRNC shall include the *Transport Layer Address IE* and the *Binding ID IE* in the RADIO LINK RECONFIGURATION RESPONSE message for any Transport Channel, HS-DSCH MAC-d flow or E-DCH MAC-d flow being added, or any Transport Channel, HS-DSCH MAC-d flow or E-DCH MAC-d flow being modified for which a new transport bearer was requested with the *Transport Bearer Request Indicator IE*. The detailed frame protocol handling during transport bearer replacement is described in [4], subclause 5.10.1.

In the case of a set of co-ordinated DCHs requiring a new transport bearer on the Iur interface, the DRNC shall include the *Transport Layer Address IE* and the *Binding ID IE* in the *DCH Information Response IE* only for one of the DCHs in the set of co-ordinated DCHs.

In the case of a Radio Link being combined with another Radio Link within the DRNS, the DRNC shall include the *Transport Layer Address IE* and the *Binding ID IE* in the *DCH Information Response IE* in the RADIO LINK RECONFIGURATION RESPONSE message for only one of the combined Radio Links.

Any allowed rate for the uplink of a modified DCH provided for the old configuration will not be valid for the new configuration. If the DRNS needs to limit the user rate in the uplink of a DCH due to congestion caused by the UL UTRAN Dynamic Resources (see subclause 9.2.1.79) in the new configuration for a Radio Link, the DRNC shall include in the RADIO LINK RECONFIGURATION RESPONSE message the *Allowed UL Rate IE* in the *DCH Information Response IE* for this Radio Link.

Any allowed rate for the downlink of a modified DCH provided for the old configuration will not be valid for the new configuration. If the DRNS needs to limit the user rate in the downlink of a DCH due to congestion caused by the DL UTRAN Dynamic Resources (see subclause 9.2.1.79) in the new configuration for a Radio Link, the DRNC shall include in the RADIO LINK RECONFIGURATION RESPONSE message the *Allowed DL Rate IE* in the *DCH Information Response IE* for this Radio Link.

The DRNS decides the maximum and minimum SIR for the uplink of the Radio Link(s), and the DRNC shall include in the RADIO LINK RECONFIGURATION RESPONSE message the *Maximum Uplink SIR IE* and *Minimum Uplink SIR IE* for each Radio Link when these values are changed.

[FDD - If the DL TX power upper or lower limit has been re-configured, the DRNC shall include the new value(s) in the *Maximum DL TX Power IE* and *Minimum DL TX Power IE* in the RADIO LINK RECONFIGURATION RESPONSE message. The DRNS shall not transmit with a higher power than indicated by the *Maximum DL TX Power IE* or lower than indicated by the *Minimum DL TX Power IE* on any DL DPCH or on the F-DPCH of the RL except, if the UE Context is configured to use DPCH in the downlink, during compressed mode, when the  $\delta P_{curr}$ , as described in ref.[10] subclause 5.2.1.3, shall be added to the maximum DL power for the associated compressed frame.]

[3.84 Mcps TDD - If the DL TX power upper or lower limit has been re-configured, the DRNC shall include the new value(s) in the *Maximum DL TX Power IE* and *Minimum DL TX Power IE* in the RADIO LINK RECONFIGURATION RESPONSE message. If the maximum or minimum power needs to be different for particular DCH type CCHs, the DRNC shall include the new value(s) for that CCH in the *CCH Maximum DL TX Power IE* and *CCH Minimum DL TX Power IE*. The DRNS shall not transmit with a higher power than indicated by the appropriate *Maximum DL TX Power IE/CCH Maximum DL TX Power IE* or lower than indicated by the appropriate *Minimum DL TX Power IE/CCH Minimum DL TX Power IE* on any DL DPCH within each CCH of the RL.]

[1.28 Mcps TDD - If the DL TX power upper or lower limit has been re-configured, the DRNC shall include the new value(s) in the *Maximum DL TX Power IE* and *Minimum DL TX Power IE* in the RADIO LINK RECONFIGURATION RESPONSE message. If the maximum or minimum power needs to be different for particular timeslots within a DCH type CCH, the DRNC shall include the new value(s) for that timeslot in the *Maximum DL TX Power IE* and *Minimum DL TX Power IE* within the *DL Timeslot Information LCR IE*. The DRNS shall not transmit with a higher power than indicated by the appropriate *Maximum DL TX Power IE* or lower than indicated by the appropriate *Minimum DL TX Power IE* on any DL DPCH within each timeslot of the RL.]

### 8.3.7.3 Unsuccessful Operation

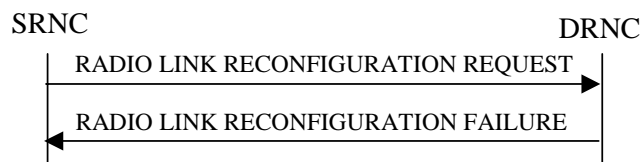

**Figure 15: Unsynchronised Radio Link Reconfiguration procedure, Unsuccessful Operation**

If the DRNS cannot allocate the necessary resources for all the new DCHs in a set of co-ordinated DCHs requested to be added, it shall reject the Unsynchronised Radio Link Reconfiguration procedure as having failed.

If the requested Unsynchronised Radio Link Reconfiguration procedure fails for one or more Radio Link(s), the DRNC shall send the RADIO LINK RECONFIGURATION FAILURE message to the SRNC, indicating the reason for failure.

Typical cause values are:

#### Radio Network Layer Causes:

- UL Scrambling Code Already in Use;
- DL Radio Resources not Available;
- UL Radio Resources not Available;
- Requested Configuration not Supported;
- CM not Supported;

- [FDD - HARQ Preamble Mode not supported].

#### Miscellaneous Causes:

- Control Processing Overload;
- Not enough User Plane Processing Resources.

### 8.3.7.4 Abnormal Conditions

If only a subset of all the DCHs belonging to a set of co-ordinated DCHs is requested to be deleted, the DRNS shall reject the Unsynchronised Radio Link Reconfiguration procedure as having failed, and the DRNC shall send the RADIO LINK RECONFIGURATION FAILURE message to the SRNC.

If more than one DCH of a set of co-ordinated DCHs has the *QE-Selector* IE set to "selected" [TDD - or no DCH of a set of co-ordinated DCHs has the *QE-Selector* IE set to "selected"], the DRNS shall reject the Unsynchronised Radio Link Reconfiguration procedure, and the DRNC shall respond with a RADIO LINK RECONFIGURATION FAILURE message.

If the RADIO LINK RECONFIGURATION REQUEST message includes a *DCHs To Modify* IE or *DCHs To Add* IE with multiple *DCH Specific Info* IEs, and if the DCHs in the *DCHs To Modify* IE or *DCHs To Add* IE do not have the same *Transmission Time Interval* IE in the *Semi-static Transport Format Information* IE, then the DRNC shall reject the procedure using the RADIO LINK RECONFIGURATION FAILURE message.

[FDD - If the RADIO LINK RECONFIGURATION REQUEST message includes the *DL Reference Power Information* IE, but the power balancing is not active in the indicated RL(s), the DRNS shall reject the Unsynchronised Radio Link Reconfiguration procedure as having failed and the DRNC shall respond the RADIO LINK RECONFIGURATION FAILURE message with the cause value "Power Balancing status not compatible".]

[FDD - If the power balancing is active with the Power Balancing Adjustment Type of the UE Context set to "Common" in the existing RL(s) but the *DL Reference Power Information* IE includes the *Individual DL Reference Power Information* IE, the DRNS shall reject the Unsynchronised Radio Link Reconfiguration procedure as having failed and the DRNC shall respond with the RADIO LINK RECONFIGURATION FAILURE message with the cause value "Power Balancing status not compatible".]

[FDD - If the power balancing is active with the Power Balancing Adjustment Type of the UE Context set to "Individual" in the existing RL(s) but the *DL Reference Power Information* IE includes the *Common DL Reference Power* IE, the DRNS shall reject the Unsynchronised Radio Link Reconfiguration procedure as having failed and the DRNC shall respond with the RADIO LINK RECONFIGURATION FAILURE message with the cause value "Power Balancing status not compatible".]

If the RADIO LINK RECONFIGURATION REQUEST message contains the *Transport Layer Address* IE or the *Binding ID* IE when establishing a transport bearer for any Transport Channel or HS-DSCH MAC-d flow being added, or any Transport Channel or HS-DSCH MAC-d flow being modified for which a new transport bearer was requested with the *Transport Bearer Request Indicator* IE., and not both are present for a transport bearer intended to be established, the DRNC shall reject the Unsynchronised Radio Link Reconfiguration procedure, and the DRNC shall respond with a RADIO LINK RECONFIGURATION FAILURE message.

If the RADIO LINK RECONFIGURATION REQUEST message contains any of the *HS-DSCH Information To Modify* IE, *HS-DSCH MAC-d Flows To Add* IE or *HS-DSCH MAC-d Flows To Delete* IE in addition to the *HS-DSCH Information* IE, the DRNC shall reject the procedure using the RADIO LINK RECONFIGURATION FAILURE message.

If the RADIO LINK RECONFIGURATION REQUEST message contains any of the *HS-DSCH Information To Modify* IE, *HS-DSCH MAC-d Flows To Add* IE, *HS-DSCH MAC-d Flows To Delete* IE or *HS-PDSCH RL ID* IE and the Serving HS-DSCH Radio Link is not in the DRNS, the DRNC shall reject the procedure using the RADIO LINK RECONFIGURATION FAILURE message.

If the RADIO LINK RECONFIGURATION REQUEST message includes the *HS-DSCH Information* IE and does not include the *HS-PDSCH RL-ID* IE, the DRNC shall reject the procedure using the RADIO LINK RECONFIGURATION FAILURE message.

If the RADIO LINK RECONFIGURATION REQUEST message includes the *HS-PDSCH RL-ID* IE indicating a Radio Link not existing in the UE Context, the DRNS shall reject the procedure using the RADIO LINK RECONFIGURATION FAILURE message.

If the RADIO LINK RECONFIGURATION REQUEST message contains any of the *HS-DSCH Information* IE, *HS-DSCH Information To Modify* IE, or *HS-DSCH MAC-d Flows To Add* IE and if in the new configuration the Priority Queues associated with the same *HS-DSCH MAC-d Flow ID* IE have the same *Scheduling Priority Indicator* IE value, the DRNC shall reject the procedure using the RADIO LINK RECONFIGURATION FAILURE message.

## 8.3.16 Compressed Mode Command [FDD]

### 8.3.16.1 General

The Compressed Mode Command procedure is used to activate or deactivate the compressed mode in the DRNS for one UE-UTRAN connection. This procedure shall use the signalling bearer connection for the relevant UE Context.

The Compressed Mode Command procedure shall not be initiated if a Prepared Reconfiguration exists, as defined in subclause 3.1.

### 8.3.16.2 Successful Operation



**Figure 26: Compressed Mode Command procedure, Successful Operation**

The procedure is initiated by the SRNC sending a COMPRESSED MODE COMMAND message to the DRNC.

Upon receipt of the COMPRESSED MODE COMMAND message from the SRNC and at the CFN indicated in the *CM Configuration Change CFN* IE, the DRNS shall deactivate all the ongoing Transmission Gap Pattern Sequences. From that moment on all Transmission Gap Pattern Sequences included in *Transmission Gap Pattern Sequence Status* IE repetitions (if present) shall be started when the indicated *TGCFN* IE elapses. The *CM Configuration Change CFN* IE in the *Active Pattern Sequence Information* IE and *TGCFN* IE for each sequence refer to the next coming CFN with that value.

If the values of the *CM Configuration Change CFN* IE and the *TGCFN* IE are equal, the concerned Transmission Gap Pattern Sequence shall be started immediately at the CFN with a value equal to the value received in the *CM Configuration Change CFN* IE.

If the concerned UE Context is configured to use F-DPCH in the downlink, the DRNS shall ignore, when activating the Transmission Gap Pattern Sequence(s), the downlink compressed mode method information, if existing, for the concerned Transmission Gap Pattern Sequence(s) in the Compressed Mode Configuration.

### 8.3.16.3 Abnormal Conditions

-

## 8.3.20 Radio Link Activation

### 8.3.20.1 General

This procedure is used to activate or de-activate the DL transmission on the Uu interface regarding selected RLS.

### 8.3.20.2 Successful Operation



**Figure 26D: Radio Link Activation procedure**

This procedure is initiated by sending the RADIO LINK ACTIVATION COMMAND message from the SRNC to the DRNC. This procedure shall use the signalling bearer connection for the relevant UE Context.

Upon receipt, the DRNS shall for each concerned RL:

- if the *Delayed Activation Update* IE indicates "Activate":
  - if the *Activation Type* IE equals "Unsynchronised":
    - [FDD - start transmission on the new RL after synchronisation is achieved in the DL user plane as specified in [4].]
    - [TDD - start transmission on the new RL immediately as specified in [4].]
  - if the *Activation Type* IE equals "Synchronised":
    - [FDD - start transmission on the new RL after synchronisation is achieved in the DL user plane as specified in [4], however never before the CFN indicated in the *Activation CFN* IE.]
    - [TDD - start transmission on the new RL at the CFN indicated in the *Activation CFN* IE as specified in [4].]
  - [FDD - the DRNS shall apply the power level indicated in the *Initial DL Tx Power* IE to the transmission on each DL DPCH or on the F-DPCH of the RL when starting transmission until either UL synchronisation on the Uu interface is achieved for the RLS or power balancing is activated. During this period no inner loop power control shall be performed and, unless activated by the DL POWER CONTROL REQUEST message, no power balancing shall be performed. The DL power shall then vary according to the inner loop power control (see ref.[10], subclause 5.2.1.2) and downlink power balancing adjustments (see 8.3.7).]
  - [TDD - the DRNS shall apply the power level indicated in the *Initial DL Tx Power* IE to the transmission on each DL DPCH and on each Time Slot of the RL when starting transmission until the UL synchronisation on the Uu interface is achieved for the RL. No inner loop power control shall be performed during this period. The DL power shall then vary according to the inner loop power control (see ref.[22], subclause 4.2.3.3).]
  - [FDD - if the *Propagation Delay* IE is included, the DRNS may use this information to speed up the detection of UL synchronisation on the Uu interface.]
  - [FDD - if the *First RLS Indicator* IE is included, it indicates if the concerned RL shall be considered part of the first RLS established towards this UE. The *First RLS Indicator* IE shall be used by the DRNS to determine the initial TPC pattern in the DL of the concerned RL and all RLS which are part of the same RLS, as described in [10], section 5.1.2.2.1.2.]
- if the *Delayed Activation Update* IE indicates "Deactivate":

- stop DL transmission immediately if the Deactivation Type IE equals "Unsynchronised", or at the CFN indicated by the Deactivation CFN IE if the Deactivation Type IE equals "Synchronised".

### 8.3.20.3 Abnormal Conditions

[FDD - If the *Delayed Activation Update* IE is included in the RADIO LINK ACTIVATION COMMAND message, it indicates "Activate" and the *First RLS Indicator* IE is not included, the DRNC shall initiate the ERROR INDICATION procedure.]

## 9.1.3 RADIO LINK SETUP REQUEST

## 9.1.3.1 FDD Message

IE/Group Name	Presence	Range	IE Type and Reference	Semantics Description	Criticality	Assigned Criticality
Message Type	M		9.2.1.40		YES	reject
Transaction ID	M		9.2.1.59		–	
SRNC-ID	M		RNC-ID 9.2.1.50		YES	reject
S-RNTI	M		9.2.1.53		YES	reject
D-RNTI	O		9.2.1.24		YES	reject
Allowed Queuing Time	O		9.2.1.2		YES	reject
<b>UL DPCH Information</b>		1			YES	reject
>UL Scrambling Code	M		9.2.2.53		–	
>Min UL Channelisation Code Length	M		9.2.2.25		–	
>Max Number of UL DPDCHs	C – CodeLen		9.2.2.24		–	
>Puncture Limit	M		9.2.1.46	For the UL.	–	
>TFCS	M		9.2.1.63		–	
>UL DPCCH Slot Format	M		9.2.2.52		–	
>Uplink SIR Target	O		Uplink SIR 9.2.1.69		–	
>Diversity mode	M		9.2.2.8		–	
>SSDT Cell Identity Length	O		9.2.2.41		–	
>S Field Length	O		9.2.2.36		–	
>DPC Mode	O		9.2.2.12A		YES	reject
>UL DPDCH Indicator for E-DCH operation	C-EDCHInfo		ENUMERATED (UL-DPDCH present, UL-DPDCH not present)		YES	reject
<b>E-DPCH Information</b>		0..1			YES	reject
>Min UL Channelisation Code Length for E-DCH FDD	M		9.2.2.25A		–	
>Max Number of UL E-DPDCHs	C-CodeLenE DCH		9.2.2.24e	more than one E-DPDCHs possible in case of SF=2	–	
>Puncture Limit	M		9.2.1.50		–	
>E-TFCS	M		9.2.1.63A		–	
>E-TTI	M		ENUMERATED (2ms, 10ms)		–	
<b>DL DPCH Information</b>		0..1			YES	reject
>TFCS	M		9.2.1.63		–	
>DL DPCH Slot Format	M		9.2.2.9		–	
>Number of DL Channelisation Codes	M		9.2.2.26A		–	
>TFCI Signalling Mode	M		9.2.2.46		–	
>TFCI Presence	C-SlotFormat		9.2.1.55		–	
>Multiplexing Position	M		9.2.2.26		–	
<b>&gt;Power Offset Information</b>		1			–	
>>PO1	M		Power Offset 9.2.2.30	Power offset for the TFCI bits.	–	
>>PO2	M		Power	Power offset	–	



IE/Group Name	Presence	Range	IE Type and Reference	Semantics Description	Criticality	Assigned Criticality
			Offset 9.2.2.30	for the TPC bits.		
>>PO3	M		Power Offset 9.2.2.30	Power offset for the pilot bits.	–	
>FDD TPC Downlink Step Size	M		9.2.2.16		–	
>Limited Power Increase	M		9.2.2.21A		–	
>Inner Loop DL PC Status	M		9.2.2.21a		–	
>Split Type	O		9.2.2.39a		YES	reject
>Length of TFCI2	O		9.2.2.21C		YES	reject
DCH Information	M		DCH FDD Information 9.2.2.4A		YES	reject
DSCH Information	O		DSCH FDD Information 9.2.2.13A		YES	reject
<b>RL Information</b>		<i>1...&lt;max number of RLS&gt;</i>			EACH	notify
>RL ID	M		9.2.1.49		–	
>C-ID	M		9.2.1.6		–	
>First RLS Indicator	M		9.2.2.16A		–	
>Frame Offset	M		9.2.1.30		–	
>Chip Offset	M		9.2.2.1		–	
>Propagation Delay	O		9.2.2.33		–	
>Diversity Control Field	C – NotFirstRL		9.2.1.20		–	
>Initial DL TX Power	O		DL Power 9.2.1.21A		–	
>Primary CPICH Ec/No	O		9.2.2.32		–	
>SSDT Cell Identity	O		9.2.2.40		–	
>Transmit Diversity Indicator	C – Diversity mode		9.2.2.48		–	
>SSDT Cell Identity for EDSCHPC	C- EDSCHPC		9.2.2.40A		YES	ignore
>Enhanced Primary CPICH Ec/No	O		9.2.2.13I		YES	ignore
>RL Specific DCH Information	O		9.2.1.49A		YES	ignore
>Delayed Activation	O		9.2.1.19Aa		YES	reject
>Qth Parameter	O		9.2.2.34a		YES	ignore
>Cell Portion ID	O		9.2.2.E		YES	ignore
>RL specific E-DCH Information	O		E-DCH MAC-d Flows Information 9.2.1.30C		YES	reject
>E-DCH RL Indication	O		9.2.2.4E		YES	reject
Transmission Gap Pattern Sequence Information	O		9.2.2.47A		YES	reject
Active Pattern Sequence Information	O		9.2.2.A		YES	reject
Permanent NAS UE Identity	O		9.2.1.73		YES	ignore
DL Power Balancing Information	O		9.2.2.10A		YES	ignore
HS-DSCH Information	O		HS-DSCH FDD Information 9.2.2.19a		YES	reject
HS-PDSCH RL ID	C – InfoHSDS		RL ID 9.2.1.49		YES	reject

IE/Group Name	Presence	Range	IE Type and Reference	Semantics Description	Criticality	Assigned Criticality
	CH					
UE Support Of Dedicated Pilots For Channel Estimation	O		9.2.2.50A		YES	ignore
UE Support Of Dedicated Pilots For Channel Estimation Of HS-DSCH	O		9.2.2.50B		YES	ignore
<b>MBMS Bearer Service List</b>		<i>0...&lt;maxnoofMBMS&gt;</i>			GLOBAL	notify
>TMGI	M		9.2.1.80		-	
E-DCH FDD Information	O		9.2.2.4B		YES	reject
Serving E-DCH RL ID	C-EDCHInfo		RL ID 9.2.1.49		YES	reject
<a href="#">F-DPCH Information</a>		<a href="#">0..1</a>			<a href="#">YES</a>	<a href="#">reject</a>
<a href="#">&gt;Power Offset Information</a>		<a href="#">1</a>			<a href="#">=</a>	
<a href="#">&gt;&gt;PO2</a>	<a href="#">M</a>		<a href="#">Power Offset 9.2.2.30</a>	<a href="#">Power offset for the TPC bits.</a>	<a href="#">-</a>	
<a href="#">&gt;FDD TPC Downlink Step Size</a>	<a href="#">M</a>		<a href="#">9.2.2.16</a>		<a href="#">=</a>	
<a href="#">&gt;Limited Power Increase</a>	<a href="#">M</a>		<a href="#">9.2.2.21A</a>		<a href="#">=</a>	
<a href="#">&gt;Inner Loop DL PC Status</a>	<a href="#">M</a>		<a href="#">9.2.2.21a</a>		<a href="#">=</a>	

Condition	Explanation
CodeLen	The IE shall be present if <i>Min UL Channelisation Code length</i> IE equals to 4
SlotFormat	The IE shall be present if the <i>DL DPCH Slot Format</i> IE is equal to any of the values from 12 to 16.
NotFirstRL	The IE shall be present if the RL is not the first one in the <i>RL Information</i> IE.
Diversity mode	The IE shall be present if <i>Diversity Mode</i> IE in <i>UL DPCH Information</i> IE is not equal to "none".
EDSCHPC	This IE shall be present if <i>Enhanced DSCH PC</i> IE is present in the <i>DSCH Information</i> IE.
InfoHSDSCH	This IE shall be present if <i>HS-DSCH Information</i> IE is present.
EDCHInfo	This IE shall be present if <i>E-DPCH Information</i> IE is present.
CodeLenEDCH	The IE shall be present if <i>Min UL Channelisation Code length for E-DCH FDD</i> IE equals to 2

Range bound	Explanation
<i>maxnoofRLs</i>	Maximum number of RLs for one UE.
<i>maxnoofMBMS</i>	Maximum number of MBMS bearer services that a UE can join.

## 9.1.6 RADIO LINK ADDITION REQUEST

## 9.1.6.1 FDD Message

IE/Group Name	Presence	Range	IE Type and Reference	Semantics Description	Criticality	Assigned Criticality
Message Type	M		9.2.1.40		YES	reject
Transaction ID	M		9.2.1.59		–	
Uplink SIR Target	M		Uplink SIR 9.2.1.69		YES	reject
<b>RL Information</b>		<i>1..&lt;maxn oofRLs- 1&gt;</i>			EACH	notify
>RL ID	M		9.2.1.49		–	
>C-ID	M		9.2.1.6		–	
>Frame Offset	M		9.2.1.30		–	
>Chip Offset	M		9.2.2.1		–	
>Diversity Control Field	M		9.2.1.20		–	
>Primary CPICH Ec/No	O		9.2.2.32		–	
>SSDT Cell Identity	O		9.2.2.40			
>Transmit Diversity Indicator	O		9.2.2.48		–	
>DL Reference Power	O		DL Power 9.2.1.21A	Power on DPCH <a href="#">or on</a> <a href="#">F-DPCH</a>	YES	ignore
>Enhanced Primary CPICH Ec/No	O		9.2.2.13I		YES	ignore
>RL Specific DCH Information	O		9.2.1.49A		YES	ignore
>Delayed Activation	O		9.2.1.19Aa		YES	reject
>Qth Parameter	O		9.2.2.34a		YES	ignore
>RL specific E-DCH Information	O		E-DCH MAC-d Flows Information 9.2.1.300 C		YES	reject
>E-DCH RL Indication	O		9.2.2.4E		YES	reject
Active Pattern Sequence Information	O		9.2.2A	Either all the already active Transmission Gap Sequence(s) are addressed (Transmission Gap Pattern sequence shall overlap with the existing one) or none of the transmission gap sequences is activated.	YES	reject
DPC Mode	O		9.2.2.12A		YES	reject
Permanent NAS UE Identity	O		9.2.1.73		YES	ignore
Serving E-DCH RL ID	C- EDCHInfo		RL ID 9.2.1.49		YES	reject

Range bound	Explanation
<i>maxnoofRLs</i>	Maximum number of radio links for one UE.

Condition	Explanation
EDCHInfo	This IE shall be present if <i>RL specific E-DCH Information</i> IE is present for at least one RL indicated in the message.

## 9.1.11 RADIO LINK RECONFIGURATION PREPARE

## 9.1.11.1 FDD Message

IE/Group Name	Presence	Range	IE Type and Reference	Semantics Description	Criticality	Assigned Criticality
Message Type	M		9.2.1.40		YES	reject
Transaction ID	M		9.2.1.59		–	
Allowed Queuing Time	O		9.2.1.2		YES	reject
<b>UL DPCH Information</b>		<i>0..1</i>			YES	reject
>UL Scrambling Code	O		9.2.2.53		–	
>UL SIR Target	O		Uplink SIR 9.2.1.69		–	
>Min UL Channelisation Code Length	O		9.2.2.25		–	
>Max Number of UL DPDCHs	C – CodeLen		9.2.2.24		–	
>Puncture Limit	O		9.2.1.46	For the UL.	–	
>TFCS	O		9.2.1.63	TFCS for the UL.	–	
>UL DPCCH Slot Format	O		9.2.2.52		–	
>Diversity Mode	O		9.2.2.8		–	
>SSDT Cell Identity Length	O		9.2.2.41		–	
>S-Field Length	O		9.2.2.36		–	
>UL DPDCH Indicator for E-DCH operation	C- EDCHInfo		ENUMERATED (UL-DPDCH present, UL-DPDCH not present)		YES	reject
<b>DL DPCH Information</b>		<i>0..1</i>			YES	reject
>TFCS	O		9.2.1.63	TFCS for the DL.	–	
>DL DPCH Slot Format	O		9.2.2.9		–	
>Number of DL Channelisation Codes	O		9.2.2.26A		–	
>TFCI Signalling Mode	O		9.2.2.46		–	
>TFCI Presence	C- SlotFormat		9.2.1.55		–	
>Multiplexing Position	O		9.2.2.26		–	
>Limited Power Increase	O		9.2.2.21A		–	
>Split Type	O		9.2.2.39a		YES	reject
>Length of TFCI2	O		9.2.2.21C		YES	reject
<b>&gt;DL DPCH Power Information</b>		<i>0..1</i>			YES	reject
<b>&gt;&gt;Power Offset Information</b>		<i>1</i>			=	
>>>PO1	M		Power Offset 9.2.2.30	Power offset for the TFCI bits	=	
>>>PO2	M		Power Offset 9.2.2.30	Power offset for the TPC bits	=	
>>>PO3	M		Power Offset 9.2.2.30	Power offset for the pilot bits	–	
>>FDD TPC Downlink	M		9.2.2.16		=	

IE/Group Name	Presence	Range	IE Type and Reference	Semantics Description	Criticality	Assigned Criticality
<a href="#">Step Size</a>						
<a href="#">&gt;&gt;Inner Loop DL PC Status</a>	M		<a href="#">9.2.2.21a</a>		=	
DCHs To Modify	O		FDD DCHs To Modify 9.2.2.13C		YES	reject
DCHs To Add	O		DCH FDD Information 9.2.2.4A		YES	reject
<b>DCHs To Delete</b>		<i>0..&lt;maxnoof DCHs&gt;</i>			GLOBAL	reject
>DCH ID	M		9.2.1.16		-	
<b>DSCHs To Modify</b>		<i>0..1</i>			YES	reject
<b>&gt;DSCH Info</b>		<i>0..&lt;maxnoof DSCHs&gt;</i>			-	
>>DSCH ID	M		9.2.1.26A		-	
>>TrCH Source Statistics Descriptor	O		9.2.1.65		-	
>>Transport Format Set	O		9.2.1.64	For DSCH	-	
>>Allocation/Retention Priority	O		9.2.1.1		-	
>>Scheduling Priority Indicator	O		9.2.1.51A		-	
>>BLER	O		9.2.1.4		-	
>>Transport Bearer Request Indicator	M		9.2.1.61		-	
>>Traffic Class	O		9.2.1.58A		YES	ignore
>>Binding ID	O		9.2.1.3	Shall be ignored if bearer establishment with ALCAP.	YES	ignore
>>Transport Layer Address	O		9.2.1.62	Shall be ignored if bearer establishment with ALCAP.	YES	ignore
>PDSCH RL ID	O		RL ID 9.2.1.49		-	
>TFCS	O		9.2.1.63	For DSCH	-	
>Enhanced DSCH PC Indicator	O		9.2.2.13F		YES	ignore
>Enhanced DSCH PC	C-EDSCHPC On		9.2.2.13D		YES	ignore
DSCHs To Add	O		DSCH FDD Information 9.2.2.13A		YES	reject
<b>DSCHs to Delete</b>		<i>0..1</i>			YES	reject
<b>&gt;DSCH Info</b>		<i>1..&lt;maxnoof DSCHs&gt;</i>			-	
>>DSCH ID	M		9.2.1.26A		-	
<b>RL Information</b>		<i>0..&lt;maxnoof RLs&gt;</i>			EACH	reject
>RL ID	M		9.2.1.49		-	
>SSDT Indication	O		9.2.2.42		-	
>SSDT Cell Identity	C-SSDTIndON		9.2.2.40		-	
>Transmit Diversity	C-		9.2.2.48		-	

IE/Group Name	Presence	Range	IE Type and Reference	Semantics Description	Criticality	Assigned Criticality
Indicator	Diversity mode					
>SSDT Cell Identity for EDSCHPC	C-EDSCHPC		9.2.2.40A		YES	ignore
>DL Reference Power	O		DL Power 9.2.1.21A	Power on DPCH	YES	ignore
>RL Specific DCH Information	O		9.2.1.49A		YES	ignore
>DL DPCH Timing Adjustment	O		9.2.2.9A	Required RL Timing Adjustment	YES	reject
>Qth Parameter	O		9.2.2.34a		YES	ignore
>Phase Reference Update Indicator	O		9.2.2.27B		YES	ignore
>RL specific E-DCH Information	O		E-DCH MAC-d Flows Information 9.2.1.300 C		<u>YES</u>	<u>reject</u>
>E-DCH MAC-d Flows to Add	O		E-DCH MAC-d Flows Information 9.2.1.300 C		YES	reject
>E-DCH MAC-d Flows to Delete	O		9.2.2.300 D		YES	reject
>E-DCH RL Indication	O		9.2.2.4E		YES	reject
Transmission Gap Pattern Sequence Information	O		9.2.2.47A		YES	reject
HS-DSCH Information	O		HS-DSCH FDD Information 9.2.2.19a		YES	reject
HS-DSCH Information To Modify	O		9.2.1.30Q		YES	reject
HS-DSCH MAC-d Flows To Add	O		HS-DSCH MAC-d Flows Information 9.2.1.300A		YES	reject
HS-DSCH MAC-d Flows To Delete	O		9.2.1.300B		YES	reject
HS-PDSCH RL ID	O		RL ID 9.2.1.49		YES	reject
UE Support Of Dedicated Pilots For Channel Estimation	O		9.2.2.50A		YES	ignore
UE Support Of Dedicated Pilots For Channel Estimation Of HS-DSCH	O		9.2.2.50B		YES	ignore
<b><u>E-DPCH Information</u></b>		<u>0..1</u>			<u>YES</u>	<u>reject</u>
>Min UL Channelisation Code Length for E-DCH FDD	<u>O</u>		<u>9.2.2.25A</u>		=	
>Max Number of E-DPCHs	<u>C-CodeLenE DCH</u>		<u>9.2.2.24e</u>	<u>more than one E-DPCHs possible in case of SF=2</u>	=	
>Puncture Limit	<u>O</u>		<u>9.2.1.50</u>		=	
>E-TFCS	<u>O</u>		<u>9.2.1.63A</u>		=	

IE/Group Name	Presence	Range	IE Type and Reference	Semantics Description	Criticality	Assigned Criticality
>E-TTI	O		ENUMERATED (2ms, 10ms)		=	
E-DCH FDD Information	O		9.2.2.4B		YES	reject
E-DCH FDD Information to Modify	O		9.2.2.4F		YES	reject
Serving E-DCH RL ID	O		RL ID 9.2.1.49		YES	reject
<b>F-DPCH Information</b>		<u>0..1</u>			<u>YES</u>	<u>reject</u>
>Power Offset Information		<u>1</u>			=	
>>PO2	M		Power Offset 9.2.2.30	Power offset for the TPC bits.	-	
>FDD TPC Downlink Step Size	M		9.2.2.16		=	
>Limited Power Increase	M		9.2.2.21A		=	
>Inner Loop DL PC Status	M		9.2.2.21a		=	

Condition	Explanation
SDDTIndOn	The IE shall be present if the <i>SDDT Indication</i> IE is set to "SDDT Active in the UE".
CodeLen	The IE shall be present only if the <i>Min UL Channelisation Code length</i> IE equals to 4.
SlotFormat	The IE shall only be present if the <i>DL DPCH Slot Format</i> IE is equal to any of the values from 12 to 16.
Diversity mode	The IE shall be present if <i>Diversity Mode</i> IE is present in the <i>UL DPCH Information</i> IE and is not equal to "none".
EDSCHPCOn	The IE shall be present if the <i>Enhanced DSCH PC Indicator</i> IE is set to "Enhanced DSCH PC Active in the UE".
EDSCHPC	The IE shall be present if <i>Enhanced DSCH PC</i> IE is present in either the <i>DSCHs To Modify</i> IE or the <i>DSCHs To Add</i> IE.
EDCHInfo	This IE shall be present if <i>E-DPCH Information</i> IE is present.
CodeLenEDCH	The IE shall be present if <i>Min UL Channelisation Code length for E-DCH FDD</i> IE equals to [2 or 4]

Range bound	Explanation
<i>maxnoofDCHs</i>	Maximum number of DCHs for a UE.
<i>maxnoofDSCHs</i>	Maximum number of DSCHs for one UE.
<i>maxnoofRLs</i>	Maximum number of RLs for a UE.



### 9.2.1.5 Cause

The purpose of the cause information element is to indicate the reason for a particular event for the whole protocol.

IE/Group Name	Presence	Range	IE Type and Reference	Semantics Description
CHOICE Cause Group	M			
>Radio Network Layer				
>>Radio Network Layer Cause	M		ENUMERATED (Unknown C-ID, Cell not Available, Power Level not Supported, UL Scrambling Code Already in Use, DL Radio Resources not Available, UL Radio Resources not Available, Measurement not Supported For The Object, Combining Resources Not Available, Combining not Supported, Reconfiguration not Allowed, Requested Configuration not Supported, Synchronisation Failure, Requested Tx Diversity Mode not Supported, Measurement Temporarily not Available, Unspecified, Invalid CM Settings, Reconfiguration CFN not Elapsed, Number of DL Codes Not Supported, Dedicated Transport Channel Type not Supported, DL Shared Channel Type not Supported, UL Shared Channel Type not Supported, Common Transport Channel Type not Supported, UL Spreading Factor not Supported, DL Spreading Factor not Supported, CM not Supported, Transaction not Supported by Destination Node B, RL Already Activated/Allocated, ..., Number of UL Codes Not Supported, Cell reserved for operator use, DPC Mode Change not Supported, Information temporarily not available, Information Provision not supported for the object, Power Balancing status not compatible, Delayed Activation not Supported, RL Timing Adjustment Not Supported, Unknown RNTI, Measurement Repetition Rate not Compatible with Current Measurements, UE not Capable to Implement Measurement, HARQ Preamble Mode not supported, <a href="#">F-DPCH not supported</a>	
>Transport Layer				
>>Transport Layer Cause	M		ENUMERATED (Transport Resource Unavailable, Unspecified, ...)	
>Protocol				
>>Protocol Cause	M		ENUMERATED (Transfer Syntax Error, Abstract Syntax Error (Reject), Abstract Syntax Error (Ignore and Notify), Message not Compatible with Receiver State, Semantic Error, Unspecified, Abstract Syntax Error (Falsely	

			Constructed Message),...)	
>Misc				
>>Miscellaneous Cause	M		ENUMERATED (Control Processing Overload, Hardware Failure, O&M Intervention, Not enough User Plane Processing Resources, Unspecified,...)	

The meaning of the different cause values is described in the following table. In general, "not supported" cause values indicate that the concerned capability is missing. On the other hand, "not available" cause values indicate that the concerned capability is present, but insufficient resources were available to perform the requested action.

Radio Network Layer cause	Meaning
Cell not Available	The concerned cell is not available
Cell reserved for operator use	The concerned cell is reserved for operator use
Combining not Supported	The DRNS does not support the RL combining for the concerned cells
Combining Resources Not Available	The value of the received <i>Diversity Control Field</i> IE was set to "Must", but the DRNS cannot perform the requested combining
CM not Supported	The concerned cell(s) do not support Compressed Mode
Common Transport Channel Type not Supported	The concerned cell(s) do not support the RACH and/or FACH and/or CPCH Common Transport Channel Type
Dedicated Transport Channel Type not Supported	The concerned cell(s) do not support the Dedicated Transport Channel Type
Delayed Activation not Supported	The concerned cell(s) do not support delayed activation of RLs
DL Radio Resources not Available	The DRNS does not have sufficient DL radio resources available
DL SF not Supported	The concerned cell(s) do not support the requested DL SF
DL Shared Channel Type not Supported	The concerned cell(s) do not support the Downlink Shared Channel Type
DPC Mode Change not Supported	The concerned cells do not support the DPC mode changes
<a href="#">F-DPCH not supported</a>	<a href="#">The concerned cell(s) do not support the Fractional DPCH</a>
HARQ Preamble Mode not supported	The concerned cell does not support the HARQ Preamble Mode
Information Provision not supported for the object	The RNS doesn't support provision of the requested information for the concerned object types
Information temporarily not available	The RNS can temporarily not provide the requested information
Invalid CM Settings	The concerned cell(s) consider the requested Compressed Mode settings invalid
Measurement not Supported For The Object	At least one of the concerned cell(s) does not support the requested measurement on the concerned object type
Measurement Repetition Rate not Compatible with Current Measurements	The requested parameters for a forwarded UE measurement are not compatible with the current measurement schedule in the SRNC.
Measurement Temporarily not Available	The DRNS can temporarily not provide the requested measurement value
Number of DL Codes not Supported	The concerned cell(s) do not support the requested number of DL codes
Number of UL Codes not Supported	The concerned cell(s) do not support the requested number of UL codes
Power Level not Supported	A DL power level was requested which the concerned cell(s) do not support
Power Balancing status not compatible	The power balancing status in the SRNC is not compatible with that of the DRNC.
RL Timing Adjustment not Supported	The concerned cell(s) do not support adjustments of the RL timing
Reconfiguration CFN not Elapsed	The requested action cannot be performed due to that a COMMIT message was received previously, but the concerned CFN has not yet elapsed
Reconfiguration not Allowed	The SRNC does currently not allow the requested reconfiguration

Requested Configuration not Supported	The concerned cell(s) do not support the requested configuration i.e. power levels, Transport Formats, physical channel parameters,.....
Requested Tx Diversity mode not Supported	The concerned cell(s) do not support the requested transmit diversity mode
RL Already Activated/ Allocated	The DRNS has already allocated an RL with the requested RL ID for this UE Context
Synchronisation Failure	Loss of UL Uu synchronisation
Transaction not Supported by Destination Node B	The requested action cannot be performed due to lack of support of the corresponding action in the destination Node B
UE not Capable to Implement Measurement	The UE is not capable to initiate/report a requested measurement due to its current state or capabilities.
UL Radio Resources not Available	The DRNS does not have sufficient UL radio resources available
UL Scrambling Code Already in Use	The concerned UL scrambling code is already in use for another UE
UL SF not Supported	The concerned cell(s) do not support the requested minimum UL SF
UL Shared Channel Type not Supported	The concerned cell(s) do not support the Uplink Shared Channel Type
Unknown C-ID	The DRNS is not aware of a cell with the provided C-ID
Unknown RNTI	The SRNC or DRNC is not aware of a UE indicated with the provided RNTI
Unspecified	Sent when none of the above cause values applies but still the cause is Radio Network Layer related

<b>Transport Network Layer cause</b>	<b>Meaning</b>
Transport resource unavailable	The required transport resources are not available
Unspecified	Sent when none of the above cause values applies but still the cause is Transport Network Layer related

<b>Protocol cause</b>	<b>Meaning</b>
Abstract Syntax Error (Reject)	The received message included an abstract syntax error and the concerned criticality indicated "reject" (see subclause 10.3)
Abstract Syntax Error (Ignore and Notify)	The received message included an abstract syntax error and the concerned criticality indicated "ignore and notify" (see subclause 10.3)
Abstract syntax error (falsely constructed message)	The received message contained IEs or IE groups in wrong order or with too many occurrences (see subclause 10.3)
Message not Compatible with Receiver State	The received message was not compatible with the receiver state (see subclause 10.4)
Semantic Error	The received message included a semantic error (see subclause 10.4)
Transfer Syntax Error	The received message included a transfer syntax error (see subclause 10.2)
Unspecified	Sent when none of the above cause values applies but still the cause is Protocol related

<b>Miscellaneous cause</b>	<b>Meaning</b>
Control Processing Overload	DRNS control processing overload
Hardware Failure	DRNS hardware failure
Not enough User Plane Processing Resources	DRNS has insufficient user plane processing resources available
O&M Intervention	Operation and Maintenance intervention related to DRNS equipment
Unspecified	Sent when none of the above cause values applies and the cause is not related to any of the categories Radio Network Layer, Transport Network Layer or Protocol.

UNCHANGED TEXT IS REMOVED

## 9.2.1.21A DL Power

The *DL Power* IE indicates a power level relative to the [FDD - primary CPICH power] [TDD - PCCPCH power] configured in a cell. [FDD - If referred to a DPCH, it indicates the power of the transmitted DPDCH symbols. [If referred to an F-DPCH, it indicates the Reference F-DPCH TX Power](#)]. If Transmit Diversity is applied to a downlink physical channel, the *DL Power* IE indicates the power offset between the linear sum of the power for this downlink physical channel on all branches and the [FDD - primary CPICH power] [TDD - PCCPCH power] configured in a cell.

[TDD - If referred to a DPCH, it indicates the power of a spreading factor 16 code, the power for a spreading factor 1 code would be 12 dB higher].

IE/Group Name	Presence	Range	IE Type and Reference	Semantics Description
DL Power			INTEGER (-350..150)	Value = DL Power / 10 Unit dB Range -35.0 .. +15.0 Step 0.1dB

UNCHANGED TEXT IS REMOVED

## 9.2.2.D Cell Capability Container FDD

The Cell Capability Container FDD indicates which functionalities a cell supports.

IE/Group Name	Presence	Range	IE Type and Reference	Semantics Description
Cell Capability Container FDD			BIT STRING (32)	Each bit indicates whether a cell supports a particular functionality or not. The value 1 of a bit indicates that the corresponding functionality is supported in a cell and value 0 indicates that the corresponding functionality is not supported in a cell. Each bit is defined as follows. The first bit: Flexible Hard Split Support Indicator. The second bit: Delayed Activation Support Indicator. The third bit: HS-DSCH Support Indicator. The fourth bit: DSCH Support Indicator. <a href="#">The fifth bit: F-DPCH Support Indicator.</a> Note that undefined bits are considered as a spare bit and spare bits shall be set to 0 by the transmitter and shall be ignored by the receiver.

UNCHANGED TEXT IS REMOVED

### 9.2.2.1 Chip Offset

The Chip Offset is defined as the radio timing offset inside a radio frame. The Chip Offset is used as offset for the DL DPCH relative to the Primary CPICH timing [for the DL DPCH or for the F-DPCH](#).

IE/Group Name	Presence	Range	IE Type and Reference	Semantics Description
Chip Offset			INTEGER (0..38399)	Unit: Chips

UNCHANGED TEXT IS REMOVED

### 9.2.2.10A DL Power Balancing Information

The *DL Power Balancing Information* IE provides information for power balancing to be activated in the relevant RL(s).

IE/Group Name	Presence	Range	IE Type and Reference	Semantics Description	Criticality	Assigned Criticality
Power Adjustment Type	M		9.2.2.28		–	
DL Reference Power	C-Common		DL power 9.2.1.21A	Power on DPCH <a href="#">or on F-DPCH</a>	–	
<b>DL Reference Power Information</b>	C-Individual	<i>1..&lt;maxnoof RLS&gt;</i>			–	
>RL ID	M		9.2.1.49		–	
>DL Reference Power	M		DL power 9.2.1.21A	Power on DPCH <a href="#">or on F-DPCH</a>	–	
Max Adjustment Step	C-CommonOrIndividual		9.2.2.23		–	
Adjustment Period	C-CommonOrIndividual		9.2.2.B		–	
Adjustment Ratio	C-CommonOrIndividual		9.2.2.C		–	

Condition	Explanation
Common	The IE shall be present if the <i>Power Adjustment Type</i> IE is set to "Common".
Individual	The IE shall be present if the <i>Power Adjustment Type</i> IE is set to "Individual".
CommonOrIndividual	The IE shall be present if the <i>Power Adjustment Type</i> IE is set to "Common" or "Individual".

Range Bound	Explanation
<i>maxnoofRLs</i>	Maximum number of Radio Links for a UE.

UNCHANGED TEXT IS REMOVED

## 9.2.2.10C DL Reference Power Information

The *DL Reference Power Information* IE provides reference power of the power balancing to be used in the relevant RL(s).

IE/Group Name	Presence	Range	IE Type and Reference	Semantics Description	Criticality	Assigned Criticality
Common DL Reference Power	O		DL power 9.2.1.21A	Power on DPCH <a href="#">or on F-DPCH</a>	–	
<b>Individual DL Reference Power Information</b>		<i>0..&lt;maxnoof RLS&gt;</i>			–	
>RL ID	M		9.2.1.49		–	
>DL Reference Power	M		DL power 9.2.1.21A	Power on DPCH <a href="#">or on F-DPCH</a>	–	

Range bound	Explanation
<i>maxnoofRLs</i>	Maximum number of RLs for a UE.

UNCHANGED TEXT IS REMOVED

## 9.2.2.14A FDD DL Code Information

The *FDD DL Code Information* IE provides FDD DL Code information for all DPCHs [or for the F-DPCH](#) of one Radio Link.

IE/Group Name	Presence	Range	IE Type and Reference	Semantics Description	Criticality	Assigned Criticality
<b>FDD DL Code Information</b>		<i>1..&lt;maxnoof DL Codes&gt;</i>			–	
>DL Scrambling Code	M		9.2.2.11		–	
>FDD DL Channelisation Code Number	M		9.2.2.14		–	
>Transmission Gap Pattern Sequence Scrambling Code Information	O		9.2.2.47B		–	

Range bound	Explanation
<i>maxnoofDL Codes</i>	Maximum number of DL Channelisation Codes for one UE.

UNCHANGED TEXT IS REMOVED

## 9.2.2.30 Power Offset

This IE defines a power offset relative to ~~respect~~ the Downlink transmission power of a DPCH in case the UE Context is configured to use DPCH in the downlink or relative to the Reference F-DPCH TX Power in case the UE Context is configured to use F-DPCH in the downlink.

IE/Group Name	Presence	Range	IE Type and Reference	Semantics Description
Power Offset			INTEGER(0..24)	Unit dB, Step 0.25 dB, Range 0..6 dB

UNCHANGED TEXT IS REMOVED

## 9.2.2.45 STTD Support Indicator

The STTD Support Indicator indicates whether the STTD can be applied to DL DPCH and F-DPCH in the cell or not.

IE/Group Name	Presence	Range	IE Type and Reference	Semantics Description
STTD Support Indicator			ENUMERATED(STTD Supported, STTD not Supported).	



### 9.3.3 PDU Definitions

```
-- *****
--
-- PDU definitions for RNSAP.
--
-- *****

RNSAP-PDU-Contents {
itu-t (0) identified-organization (4) etsi (0) mobileDomain (0)
umts-Access (20) modules (3) rnsap (1) version1 (1) rnsap-PDU-Contents (1) }

DEFINITIONS AUTOMATIC TAGS ::=

BEGIN

-- *****
--
-- IE parameter types from other modules.
--
-- *****

IMPORTS

UNCHANGED TEXT IS REMOVED

id-Active-MBMS-Bearer-Service-UplinkSigTrFDD,
id-Active-MBMS-Bearer-Service-UplinkSigTrTDD,
id-Active-Pattern-Sequence-Information,
id-AdjustmentRatio,
id-AffectedUEInformationForMBMS,
id-AllowedQueuingTime,
id-AntennaColocationIndicator,
id-BindingID,
id-C-ID,
id-C-RNTI,
id-CFN,
id-CFNReportingIndicator,
id-CN-CS-DomainIdentifier,
id-CN-PS-DomainIdentifier,
id-Cause,
id-CauseLevel-RL-AdditionFailureFDD,
id-CauseLevel-RL-AdditionFailureTDD,
id-CauseLevel-RL-ReconfFailure,
id-CauseLevel-RL-SetupFailureFDD,
id-CauseLevel-RL-SetupFailureTDD,
id-CCTrCH-InformationItem-RL-FailureInd,
id-CCTrCH-InformationItem-RL-RestoreInd,
id-CellCapabilityContainer-FDD,
id-CellCapabilityContainer-TDD,
id-CellCapabilityContainer-TDD-LCR,
```

id-CellPortionID,  
id-ClosedLoopModel-SupportIndicator,  
id-ClosedLoopMode2-SupportIndicator,  
id-CNOriginatedPage-PagingRqst,  
id-CommonMeasurementAccuracy,  
id-CommonMeasurementObjectType-CM-Rprt,  
id-CommonMeasurementObjectType-CM-Rqst,  
id-CommonMeasurementObjectType-CM-Rsp,  
id-CommonMeasurementType,  
id-CommonTransportChannelResourcesInitialisationNotRequired,  
id-CongestionCause,  
id-CoverageIndicator,  
id-CriticalityDiagnostics,  
id-D-RNTI,  
id-D-RNTI-ReleaseIndication,  
id-DCHs-to-Add-FDD,  
id-DCHs-to-Add-TDD,  
id-DCH-DeleteList-RL-ReconfPrepFDD,  
id-DCH-DeleteList-RL-ReconfPrepTDD,  
id-DCH-DeleteList-RL-ReconfRqstFDD,  
id-DCH-DeleteList-RL-ReconfRqstTDD,  
id-DCH-FDD-Information,  
id-DCH-TDD-Information,  
id-FDD-DCHs-to-Modify,  
id-TDD-DCHs-to-Modify,  
id-DCH-InformationResponse,  
id-DCH-Rate-InformationItem-RL-CongestInd,  
id-DL-CCTrCH-InformationAddItem-RL-ReconfPrepTDD,  
id-DL-CCTrCH-InformationDeleteItem-RL-ReconfPrepTDD,  
id-DL-CCTrCH-InformationModifyItem-RL-ReconfPrepTDD,  
id-DL-CCTrCH-InformationListIE-RL-ReconfReadyTDD,  
id-DL-CCTrCH-InformationModifyItem-RL-ReconfRqstTDD,  
id-DL-CCTrCH-InformationDeleteItem-RL-ReconfRqstTDD,  
id-DL-CCTrCH-InformationItem-RL-SetupRqstTDD,  
id-DL-CCTrCH-InformationListIE-PhyChReconfRqstTDD,  
id-DL-CCTrCH-InformationListIE-RL-AdditionRspTDD,  
id-DL-CCTrCH-InformationListIE-RL-SetupRspTDD,  
id-DL-CCTrCH-InformationAddList-RL-ReconfPrepTDD,  
id-DL-CCTrCH-InformationDeleteList-RL-ReconfPrepTDD,  
id-DL-CCTrCH-InformationModifyList-RL-ReconfPrepTDD,  
id-DL-CCTrCH-InformationDeleteList-RL-ReconfRqstTDD,  
id-DL-CCTrCH-InformationModifyList-RL-ReconfRqstTDD,  
id-DL-CCTrCH-InformationList-RL-SetupRqstTDD,  
id-FDD-DL-CodeInformation,  
id-DL-DPCH-Information-RL-ReconfPrepFDD,  
id-DL-DPCH-Information-RL-SetupRqstFDD,  
id-DL-DPCH-Information-RL-ReconfRqstFDD,  
id-DL-DPCH-InformationItem-PhyChReconfRqstTDD,  
id-DL-DPCH-InformationItem-RL-AdditionRspTDD,  
id-DL-DPCH-InformationItem-RL-SetupRspTDD,  
id-DL-DPCH-InformationAddListIE-RL-ReconfReadyTDD,  
id-DL-DPCH-InformationDeleteListIE-RL-ReconfReadyTDD,  
id-DL-DPCH-InformationModifyListIE-RL-ReconfReadyTDD,

id-DL-DPCH-TimingAdjustment,  
id-DL-DPCH-Power-Information-RL-ReconfPrepFDD,  
id-DL-Physical-Channel-Information-RL-SetupRqstTDD,  
id-DL-PowerBalancing-Information,  
id-DL-PowerBalancing-ActivationIndicator,  
id-DL-PowerBalancing-UpdatedIndicator,  
id-DL-ReferencePowerInformation,  
id-DLReferencePower,  
id-DLReferencePowerList-DL-PC-Rqst,  
id-DL-ReferencePowerInformation-DL-PC-Rqst,  
id-DRXCycleLengthCoefficient,  
id-DedicatedMeasurementObjectType-DM-Fail,  
id-DedicatedMeasurementObjectType-DM-Fail-Ind,  
id-DedicatedMeasurementObjectType-DM-Rprt,  
id-DedicatedMeasurementObjectType-DM-Rqst,  
id-DedicatedMeasurementObjectType-DM-Rsp,  
id-DedicatedMeasurementType,  
id-DelayedActivation,  
id-DelayedActivationList-RL-ActivationCmdFDD,  
id-DelayedActivationList-RL-ActivationCmdTDD,  
id-DelayedActivationInformation-RL-ActivationCmdFDD,  
id-DelayedActivationInformation-RL-ActivationCmdTDD,  
id-DPC-Mode,  
id-DPC-Mode-Change-SupportIndicator,  
id-DRNC-ID,  
id-DSCHs-to-Add-FDD,  
id-DSCHs-to-Add-TDD,  
id-DSCH-DeleteList-RL-ReconfPrepTDD,  
id-DSCH-Delete-RL-ReconfPrepFDD,  
id-DSCH-FDD-Information,  
id-DSCH-InformationListIE-RL-AdditionRspTDD,  
id-DSCH-InformationListIEs-RL-SetupRspTDD,  
id-DSCH-TDD-Information,  
id-DSCH-FDD-InformationResponse,  
id-DSCH-ModifyList-RL-ReconfPrepTDD,  
id-DSCH-Modify-RL-ReconfPrepFDD,  
id-DSCH-RNTI,  
id-DSCHsToBeAddedOrModified-FDD,  
id-DSCHsToBeAddedOrModifiedList-RL-ReconfReadyTDD,  
id-EnhancedDSCHPC,  
id-EnhancedDSCHPCIndicator,  
id-Enhanced-PrimaryCPICH-EcNo,  
id-FACH-InfoForUESelectedS-CCPCH-CTCH-ResourceRspFDD,  
id-FACH-InfoForUESelectedS-CCPCH-CTCH-ResourceRspTDD,  
id-F-DPCH-Information-RL-ReconfPrepFDD,  
id-F-DPCH-Information-RL-SetupRqstFDD,  
id-GA-Cell,  
id-GA-CellAdditionalShapes,  
id-GSM-Cell-InfEx-Rqst,  
id-HCS-Prio,  
id-HSDSCH-FDD-Information,  
id-HSDSCH-FDD-Information-Response,  
id-HSDSCH-FDD-Update-Information,

id-HSDSCH-TDD-Update-Information,  
id-HSDSCH-Information-to-Modify,  
id-HSDSCH-Information-to-Modify-Unsynchronised,  
id-HSDSCH-MACdFlows-to-Add,  
id-HSDSCH-MACdFlows-to-Delete,  
id-HSDSCHMacdFlowSpecificInformationList-RL-PreemptRequiredInd,  
id-HSDSCHMacdFlowSpecificInformationItem-RL-PreemptRequiredInd,  
id-HSDSCH-RNTI,  
id-HSDSCH-TDD-Information,  
id-HSDSCH-TDD-Information-Response,  
id-HSPDSCH-RL-ID,  
id-HSPDSCH-Timeslot-InformationList-PhyChReconfRqstTDD,  
id-HSPDSCH-Timeslot-InformationListLCR-PhyChReconfRqstTDD,  
id-HSSICH-Info-DM-Rprt,  
id-HSSICH-Info-DM-Rqst,  
id-HSSICH-Info-DM,  
id-IMSI,  
id-InformationExchangeID,  
id-InformationExchangeObjectType-InfEx-Rprt,  
id-InformationExchangeObjectType-InfEx-Rqst,  
id-InformationExchangeObjectType-InfEx-Rsp,  
id-InformationReportCharacteristics,  
id-InformationType,  
id-InnerLoopDLPCStatus,  
id-InterfacesToTraceItem,  
id-SplitType,  
id-LengthOfTFICI2,  
id-L3-Information,  
id-AdjustmentPeriod,  
id-ListOfInterfacesToTrace,  
id-MaxAdjustmentStep,  
id-MBMS-Bearer-Service-List,  
id-MBMS-Bearer-Service-List-InfEx-Rsp,  
id-MeasurementFilterCoefficient,  
id-MeasurementID,  
id-MeasurementRecoveryBehavior,  
id-MeasurementRecoveryReportingIndicator,  
id-MeasurementRecoverySupportIndicator,  
id-Multiple-RL-InformationResponse-RL-ReconfReadyTDD,  
id-NACC-Related-Data,  
id-Old-URA-ID,  
id-PagingArea-PagingRqst,  
id-PartialReportingIndicator,  
id-PDSCH-RL-ID,  
id-Permanent-NAS-UE-Identity,  
id-Phase-Reference-Update-Indicator,  
id-FACH-FlowControlInformation,  
id-PowerAdjustmentType,  
id-PrimCCPCH-RSCP-DL-PC-RqstTDD,  
id-Primary-CPICH-Usage-For-Channel-Estimation,  
id-PropagationDelay,  
id-Qth-Parameter,  
id-RANAP-RelocationInformation,

id-ResetIndicator,  
id-RL-Information-PhyChReconfRqstFDD,  
id-RL-Information-PhyChReconfRqstTDD,  
id-RL-Information-RL-AdditionRqstFDD,  
id-RL-Information-RL-AdditionRqstTDD,  
id-RL-Information-RL-DeletionRqst,  
id-RL-Information-RL-FailureInd,  
id-RL-Information-RL-ReconfPrepFDD,  
id-RL-Information-RL-ReconfPrepTDD,  
id-RL-Information-RL-RestoreInd,  
id-RL-Information-RL-SetupRqstFDD,  
id-RL-Information-RL-SetupRqstTDD,  
id-RL-InformationItem-RL-CongestInd,  
id-RL-InformationItem-DM-Rprt,  
id-RL-InformationItem-DM-Rqst,  
id-RL-InformationItem-DM-Rsp,  
id-RL-InformationItem-RL-PreemptRequiredInd,  
id-RL-InformationItem-RL-SetupRqstFDD,  
id-RL-InformationList-RL-CongestInd,  
id-RL-InformationList-RL-AdditionRqstFDD,  
id-RL-InformationList-RL-DeletionRqst,  
id-RL-InformationList-RL-PreemptRequiredInd,  
id-RL-InformationList-RL-ReconfPrepFDD,  
id-RL-InformationResponse-RL-AdditionRspTDD,  
id-RL-InformationResponse-RL-ReconfReadyTDD,  
id-RL-InformationResponse-RL-ReconfRspTDD,  
id-RL-InformationResponse-RL-SetupRspTDD,  
id-RL-InformationResponseItem-RL-AdditionRspFDD,  
id-RL-InformationResponseItem-RL-ReconfReadyFDD,  
id-RL-InformationResponseItem-RL-ReconfRspFDD,  
id-RL-InformationResponseItem-RL-SetupRspFDD,  
id-RL-InformationResponseList-RL-AdditionRspFDD,  
id-RL-InformationResponseList-RL-ReconfReadyFDD,  
id-RL-InformationResponseList-RL-ReconfRspFDD,  
id-RL-InformationResponseList-RL-SetupRspFDD,  
id-RL-ParameterUpdateIndicationFDD-RL-Information-Item,  
id-RL-ParameterUpdateIndicationFDD-RL-InformationList,  
id-RL-ReconfigurationFailure-RL-ReconfFail,  
id-RL-ReconfigurationRequestFDD-RL-InformationList,  
id-RL-ReconfigurationRequestFDD-RL-Information-IES,  
id-RL-ReconfigurationRequestTDD-RL-Information,  
id-RL-ReconfigurationResponseTDD-RL-Information,  
id-RL-Specific-DCH-Info,  
id-RL-Set-InformationItem-DM-Rprt,  
id-RL-Set-InformationItem-DM-Rqst,  
id-RL-Set-InformationItem-DM-Rsp,  
id-RL-Set-Information-RL-FailureInd,  
id-RL-Set-Information-RL-RestoreInd,  
id-RL-Set-Successful-InformationItem-DM-Fail,  
id-RL-Set-Unsuccessful-InformationItem-DM-Fail,  
id-RL-Set-Unsuccessful-InformationItem-DM-Fail-Ind,  
id-RL-Successful-InformationItem-DM-Fail,  
id-RL-Unsuccessful-InformationItem-DM-Fail,

id-RL-Unsuccessful-InformationItem-DM-Fail-Ind,  
id-ReportCharacteristics,  
id-Reporting-Object-RL-FailureInd,  
id-Reporting-Object-RL-RestoreInd,  
id-RNC-ID,  
id-RxTimingDeviationForTA,  
id-S-RNTI,  
id-SAI,  
id-Secondary-CPICH-Information,  
id-Secondary-CPICH-Information-Change,  
id-SFN,  
id-SFNReportingIndicator,  
id-SNA-Information,  
id-SRNC-ID,  
id-SSDT-CellIDforEDSCHPC,  
id-STTD-SupportIndicator,  
id-SuccessfulRL-InformationResponse-RL-AdditionFailureFDD,  
id-SuccessfulRL-InformationResponse-RL-SetupFailureFDD,  
id-TDD-maxNrDLPhysicalchannels,  
id-TDD-Support-8PSK,  
id-TFCI-PC-SupportIndicator,  
id-timeSlot-ISCP,  
id-TimeSlot-RL-SetupRspTDD,  
id-TMGI,  
id-TnlQos,  
id-TraceDepth,  
id-TraceRecordingSessionReference,  
id-TraceReference,  
id-TransmissionMode,  
id-TransportBearerID,  
id-TransportBearerRequestIndicator,  
id-TransportLayerAddress,  
id-UC-ID,  
id-ContextInfoItem-Reset,  
id-ContextGroupInfoItem-Reset,  
id-Transmission-Gap-Pattern-Sequence-Information,  
id-UEIdentity,  
id-UEMeasurementType,  
id-UEMeasurementTimeslotInfoHCR,  
id-UEMeasurementTimeslotInfoLCR,  
id-UEMeasurementReportCharacteristics,  
id-UEMeasurementParameterModAllow,  
id-UEMeasurementValueInformation,  
id-UE-Support-Of-Dedicated-Pilots-For-Channel-Estimation,  
id-UE-Support-Of-Dedicated-Pilots-For-Channel-Estimation-Of-HS-DSCH,  
id-UE-State,  
id-UL-CCTrCH-AddInformation-RL-ReconfPrepTDD,  
id-UL-CCTrCH-DeleteInformation-RL-ReconfPrepTDD,  
id-UL-CCTrCH-ModifyInformation-RL-ReconfPrepTDD,  
id-UL-CCTrCH-InformationDeleteItem-RL-ReconfRqstTDD,  
id-UL-CCTrCH-InformationModifyItem-RL-ReconfRqstTDD,  
id-UL-CCTrCH-InformationAddList-RL-ReconfPrepTDD,  
id-UL-CCTrCH-InformationDeleteList-RL-ReconfPrepTDD,

id-UL-CCTrCH-InformationModifyList-RL-ReconfPrepTDD,  
id-UL-CCTrCH-InformationDeleteList-RL-ReconfRqstTDD,  
id-UL-CCTrCH-InformationModifyList-RL-ReconfRqstTDD,  
id-UL-CCTrCH-InformationItem-RL-SetupRqstTDD,  
id-UL-CCTrCH-InformationList-RL-SetupRqstTDD,  
id-UL-CCTrCH-InformationListIE-PhyChReconfRqstTDD,  
id-UL-CCTrCH-InformationListIE-RL-AdditionRspTDD,  
id-UL-CCTrCH-InformationListIE-RL-ReconfReadyTDD,  
id-UL-CCTrCH-InformationListIE-RL-SetupRspTDD,  
id-UL-DPCH-Information-RL-ReconfPrepFDD,  
id-UL-DPCH-Information-RL-ReconfRqstFDD,  
id-UL-DPCH-Information-RL-SetupRqstFDD,  
id-UL-DPCH-InformationItem-PhyChReconfRqstTDD,  
id-UL-DPCH-InformationItem-RL-AdditionRspTDD,  
id-UL-DPCH-InformationItem-RL-SetupRspTDD,  
id-UL-DPCH-InformationAddListIE-RL-ReconfReadyTDD,  
id-UL-DPCH-InformationDeleteListIE-RL-ReconfReadyTDD,  
id-UL-DPCH-InformationModifyListIE-RL-ReconfReadyTDD,  
id-UL-Physical-Channel-Information-RL-SetupRqstTDD,  
id-UL-SIRTarget,  
id-URA-ID,  
id-URA-Information,  
id-UnsuccessfulRL-InformationResponse-RL-AdditionFailureFDD,  
id-UnsuccessfulRL-InformationResponse-RL-AdditionFailureTDD,  
id-UnsuccessfulRL-InformationResponse-RL-SetupFailureFDD,  
id-UnsuccessfulRL-InformationResponse-RL-SetupFailureTDD,  
id-USCHs-to-Add,  
id-USCH-DeleteList-RL-ReconfPrepTDD,  
id-USCH-InformationListIE-RL-AdditionRspTDD,  
id-USCH-InformationListIEs-RL-SetupRspTDD,  
id-USCH-Information,  
id-USCH-ModifyList-RL-ReconfPrepTDD,  
id-USCHToBeAddedOrModifiedList-RL-ReconfReadyTDD,  
id-DL-Timeslot-ISCP-LCR-Information-RL-SetupRqstTDD,  
id-RL-LCR-InformationResponse-RL-SetupRspTDD,  
id-UL-CCTrCH-LCR-InformationListIE-RL-SetupRspTDD,  
id-UL-DPCH-LCR-InformationItem-RL-SetupRspTDD,  
id-DL-CCTrCH-LCR-InformationListIE-RL-SetupRspTDD,  
id-DL-DPCH-LCR-InformationItem-RL-SetupRspTDD,  
id-DSCH-LCR-InformationListIEs-RL-SetupRspTDD,  
id-USCH-LCR-InformationListIEs-RL-SetupRspTDD,  
id-DL-Timeslot-ISCP-LCR-Information-RL-AdditionRqstTDD,  
id-RL-LCR-InformationResponse-RL-AdditionRspTDD,  
id-UL-CCTrCH-LCR-InformationListIE-RL-AdditionRspTDD,  
id-UL-DPCH-LCR-InformationItem-RL-AdditionRspTDD,  
id-DL-CCTrCH-LCR-InformationListIE-RL-AdditionRspTDD,  
id-DL-DPCH-LCR-InformationItem-RL-AdditionRspTDD,  
id-DSCH-LCR-InformationListIEs-RL-AdditionRspTDD,  
id-USCH-LCR-InformationListIEs-RL-AdditionRspTDD,  
id-UL-DPCH-LCR-InformationAddListIE-RL-ReconfReadyTDD,  
id-UL-Timeslot-LCR-InformationModifyList-RL-ReconfReadyTDD,  
id-DL-DPCH-LCR-InformationAddListIE-RL-ReconfReadyTDD,  
id-DL-Timeslot-LCR-InformationModifyList-RL-ReconfReadyTDD,

id-UL-Timeslot-LCR-InformationList-PhyChReconfRqstTDD,  
id-DL-Timeslot-LCR-InformationList-PhyChReconfRqstTDD,  
id-timeSlot-ISCP-LCR-List-DL-PC-Rqst-TDD,  
id-TSTD-Support-Indicator-RL-SetupRqstTDD,  
id-PrimaryCCPCH-RSCP-RL-ReconfPrepTDD,  
id-DL-TimeSlot-ISCP-Info-RL-ReconfPrepTDD,  
id-DL-Timeslot-ISCP-LCR-Information-RL-ReconfPrepTDD,  
id-neighbouringTDDCellMeasurementInformationLCR,  
id-UL-SIR-Target-CCTrCH-InformationItem-RL-SetupRspTDD,  
id-UL-SIR-Target-CCTrCH-LCR-InformationItem-RL-SetupRspTDD,  
id-TrafficClass,  
id-UL-Synchronisation-Parameters-LCR,  
id-TDD-DL-DPCH-TimeSlotFormatModifyItem-LCR-RL-ReconfReadyTDD,  
id-TDD-UL-DPCH-TimeSlotFormatModifyItem-LCR-RL-ReconfReadyTDD,  
id-MACHs-ResetIndicator,  
id-UL-TimingAdvanceCtrl-LCR,  
id-CCTrCH-Maximum-DL-Power-RL-SetupRspTDD,  
id-CCTrCH-Minimum-DL-Power-RL-SetupRspTDD,  
id-CCTrCH-Maximum-DL-Power-RL-AdditionRspTDD,  
id-CCTrCH-Minimum-DL-Power-RL-AdditionRspTDD,  
id-CCTrCH-Maximum-DL-Power-RL-ReconfReadyTDD,  
id-CCTrCH-Minimum-DL-Power-RL-ReconfReadyTDD,  
id-Maximum-DL-Power-TimeSlotLCR-InformationModifyItem-RL-ReconfReadyTDD,  
id-Minimum-DL-Power-TimeSlotLCR-InformationModifyItem-RL-ReconfReadyTDD,  
id-DL-CCTrCH-InformationList-RL-ReconfRspTDD,  
id-DL-DPCH-InformationModifyItem-LCR-RL-ReconfRspTDD,  
id-TDD-TPC-UplinkStepSize-LCR-RL-SetupRqstTDD,  
id-UL-CCTrCH-InformationList-RL-AdditionRqstTDD,  
id-UL-CCTrCH-InformationItem-RL-AdditionRqstTDD,  
id-DL-CCTrCH-InformationList-RL-AdditionRqstTDD,  
id-DL-CCTrCH-InformationItem-RL-AdditionRqstTDD,  
id-TDD-TPC-UplinkStepSize-InformationAdd-LCR-RL-ReconfPrepTDD,  
id-TDD-TPC-UplinkStepSize-InformationModify-LCR-RL-ReconfPrepTDD,  
id-TDD-TPC-DownlinkStepSize-InformationAdd-RL-ReconfPrepTDD,  
id-TDD-TPC-DownlinkStepSize-InformationModify-RL-ReconfPrepTDD,  
id-PrimaryCCPCH-RSCP-Delta

FROM RNSAP-Constants;



```

-- *****
--
-- RADIO LINK SETUP REQUEST FDD
--
-- *****

RadioLinkSetupRequestFDD ::= SEQUENCE {
    protocolIEs                ProtocolIE-Container    {{RadioLinkSetupRequestFDD-IEs}},
    protocolExtensions         ProtocolExtensionContainer {{RadioLinkSetupRequestFDD-Extensions}}    OPTIONAL,
    ...
}

RadioLinkSetupRequestFDD-IEs RNSAP-PROTOCOL-IES ::= {
    { ID id-SRNC-ID            CRITICALITY reject TYPE RNC-ID            PRESENCE mandatory } |
    { ID id-S-RNTI            CRITICALITY reject TYPE S-RNTI            PRESENCE mandatory } |
    { ID id-D-RNTI            CRITICALITY reject TYPE D-RNTI            PRESENCE optional } |
    { ID id-AllowedQueuingTime CRITICALITY reject TYPE AllowedQueuingTime PRESENCE optional } |
    { ID id-UL-DPCH-Information-RL-SetupRqstFDD CRITICALITY reject TYPE UL-DPCH-Information-RL-SetupRqstFDD PRESENCE mandatory } |
    { ID id-DL-DPCH-Information-RL-SetupRqstFDD CRITICALITY reject TYPE DL-DPCH-Information-RL-SetupRqstFDD PRESENCE mandatoryoptional } |
    { ID id-DCH-FDD-Information CRITICALITY reject TYPE DCH-FDD-Information PRESENCE mandatory } |
    { ID id-DSCH-FDD-Information CRITICALITY reject TYPE DSCH-FDD-Information PRESENCE optional } |
    { ID id-RL-Information-RL-SetupRqstFDD CRITICALITY notify TYPE RL-InformationList-RL-SetupRqstFDD PRESENCE mandatory } |
    { ID id-Transmission-Gap-Pattern-Sequence-Information CRITICALITY reject TYPE Transmission-Gap-Pattern-Sequence-Information PRESENCE optional } |
    { ID id-Active-Pattern-Sequence-Information CRITICALITY reject TYPE Active-Pattern-Sequence-Information PRESENCE optional },
    ...
}

UL-DPCH-Information-RL-SetupRqstFDD ::= SEQUENCE {
    ul-ScramblingCode          UL-ScramblingCode,
    minUL-ChannelisationCodeLength MinUL-ChannelisationCodeLength,
    maxNrOfUL-DPCHs            MaxNrOfUL-DPCHs            OPTIONAL
    -- This IE shall be present if minUL-ChannelisationCodeLength equals to 4 -- ,
    ul-PunctureLimit           PunctureLimit,
    ul-TFCS                     TFCS,
    ul-DPCCH-SlotFormat        UL-DPCCH-SlotFormat,
    ul-SIRTarget                UL-SIR                    OPTIONAL,
    diversityMode               DiversityMode,
    sSDT-CellIDLength          SSDT-CellID-Length        OPTIONAL,
    s-FieldLength               S-FieldLength            OPTIONAL,
    iE-Extensions               ProtocolExtensionContainer { {UL-DPCH-Information-RL-SetupRqstFDD-ExtIEs} } OPTIONAL,
    ...
}

UL-DPCH-Information-RL-SetupRqstFDD-ExtIEs RNSAP-PROTOCOL-EXTENSION ::= {
    { ID id-DPC-Mode           CRITICALITY reject EXTENSION DPC-Mode PRESENCE optional },
    ...
}

DL-DPCH-Information-RL-SetupRqstFDD ::= SEQUENCE {
    tFCS                        TFCS,
    dl-DPCH-SlotFormat          DL-DPCH-SlotFormat,
    nrOfDLchannelisationcodes   NrOfDLchannelisationcodes,

```

```

tFCI-SignallingMode      TFCI-SignallingMode,
tFCI-Presence            TFCI-Presence      OPTIONAL
-- This IE shall be present if DL DPCH Slot Format IE is equal to any of the values from 12 to 16 --,
multiplexingPosition     MultiplexingPosition,
powerOffsetInformation    PowerOffsetInformation-RL-SetupRqstFDD,
fdd-dl-TPC-DownlinkStepSize FDD-TPC-DownlinkStepSize,
limitedPowerIncrease      LimitedPowerIncrease,
innerLoopDLPCStatus      InnerLoopDLPCStatus,
iE-Extensions           ProtocolExtensionContainer { {DL-DPCH-Information-RL-SetupRqstFDD-ExtIEs} } OPTIONAL,
...
}

DL-DPCH-Information-RL-SetupRqstFDD-ExtIEs RNSAP-PROTOCOL-EXTENSION ::= {
  { ID id-SplitType CRITICALITY reject EXTENSION SplitType PRESENCE optional }|
  { ID id-LengthOfTFCI2 CRITICALITY reject EXTENSION LengthOfTFCI2 PRESENCE optional },
  ...
}

PowerOffsetInformation-RL-SetupRqstFDD ::= SEQUENCE {
  po1-ForTFCI-Bits      PowerOffset,
  po2-ForTPC-Bits       PowerOffset,
  po3-ForPilotBits      PowerOffset,
  iE-Extensions         ProtocolExtensionContainer { { PowerOffsetInformation-RL-SetupRqstFDD-ExtIEs} } OPTIONAL,
  ...
}

PowerOffsetInformation-RL-SetupRqstFDD-ExtIEs RNSAP-PROTOCOL-EXTENSION ::= {
  ...
}

RL-InformationList-RL-SetupRqstFDD ::= SEQUENCE (SIZE (1..maxNrOfRLs)) OF ProtocolIE-Single-Container { {RL-InformationItemIEs-RL-SetupRqstFDD} }

RL-InformationItemIEs-RL-SetupRqstFDD RNSAP-PROTOCOL-IES ::= {
  { ID id-RL-InformationItem-RL-SetupRqstFDD CRITICALITY notify TYPE RL-InformationItem-RL-SetupRqstFDD PRESENCE mandatory }
}

RL-InformationItem-RL-SetupRqstFDD ::= SEQUENCE {
  rL-ID                RL-ID,
  c-ID                 C-ID,
  firstRLS-indicator   FirstRLS-Indicator,
  frameOffset          FrameOffset,
  chipOffset           ChipOffset,
  propagationDelay     PropagationDelay      OPTIONAL,
  diversityControlField DiversityControlField OPTIONAL
  -- This IE shall be present if the RL is not the first one in the RL-InformationList-RL-SetupRqstFDD --,
  dl-InitialTX-Power   DL-Power              OPTIONAL,
  primaryCPICH-EcNo    PrimaryCPICH-EcNo     OPTIONAL,
  sSDT-CellID          SSDT-CellID           OPTIONAL,
  transmitDiversityIndicator TransmitDiversityIndicator OPTIONAL,
  -- This IE shall be present unless Diversity Mode IE in UL DPCH Information group is "none"
  iE-Extensions        ProtocolExtensionContainer { {RL-InformationItem-RL-SetupRqstFDD-ExtIEs} } OPTIONAL,
  ...
}

```

```

}
RL-InformationItem-RL-SetupRqstFDD-ExtIEs RNSAP-PROTOCOL-EXTENSION ::= {
  { ID id-SSDT-CellIDforEDSCHPC      CRITICALITY ignore  EXTENSION SSDT-CellID          PRESENCE conditional }|
  -- This IE shall be present if Enhanced DSCH PC IE is present in the DSCH Information IE.
  { ID id-Enhanced-PrimaryCPICH-EcNo CRITICALITY ignore  EXTENSION Enhanced-PrimaryCPICH-EcNo PRESENCE optional }|
  { ID id-RL-Specific-DCH-Info       CRITICALITY ignore  EXTENSION RL-Specific-DCH-Info       PRESENCE optional }|
  { ID id-DelayedActivation           CRITICALITY reject  EXTENSION DelayedActivation          PRESENCE optional }|
  { ID id-Qth-Parameter               CRITICALITY ignore  EXTENSION Qth-Parameter              PRESENCE optional }|
  { ID id-CellPortionID               CRITICALITY ignore  EXTENSION CellPortionID              PRESENCE optional },
  ...
}

```

```

RadioLinkSetupRequestFDD-Extensions RNSAP-PROTOCOL-EXTENSION ::= {
  { ID id-Permanent-NAS-UE-Identity   CRITICALITY ignore  EXTENSION Permanent-NAS-UE-Identity PRESENCE optional }|
  { ID id-DL-PowerBalancing-Information CRITICALITY ignore  EXTENSION DL-PowerBalancing-Information PRESENCE optional }|
  { ID id-HSDSCH-FDD-Information       CRITICALITY reject  EXTENSION HSDSCH-FDD-Information     PRESENCE optional }|
  { ID id-HSPDSCH-RL-ID                CRITICALITY reject  EXTENSION RL-ID                       PRESENCE conditional }|
  -- This IE shall be present if HS-DSCH Information IE is present.
  { ID id-UE-Support-Of-Dedicated-Pilots-For-Channel-Estimation CRITICALITY ignore  EXTENSION UE-Support-Of-Dedicated-Pilots-For-Channel-Estimation PRESENCE optional }|
  { ID id-UE-Support-Of-Dedicated-Pilots-For-Channel-Estimation-Of-HS-DSCH CRITICALITY ignore  EXTENSION UE-Support-Of-Dedicated-Pilots-For-Channel-Estimation-Of-HS-DSCH PRESENCE optional }|
  { ID id-MBMS-Bearer-Service-List     CRITICALITY notify  EXTENSION MBMS-Bearer-Service-List   PRESENCE optional }|
  { ID id-F-DPCH-Information-RL-SetupRqstFDD CRITICALITY reject  EXTENSION F-DPCH-Information-RL-SetupRqstFDD PRESENCE optional },
  ...
}

```

```

F-DPCH-Information-RL-SetupRqstFDD ::= SEQUENCE {
  powerOffsetInformation PowerOffsetInformation-F-DPCH-RL-SetupRqstFDD,
  fdd-dl-TPC-DownlinkStepSize FDD-TPC-DownlinkStepSize,
  limitedPowerIncrease LimitedPowerIncrease,
  innerLoopDLPCStatus InnerLoopDLPCStatus,
  iE-Extensions ProtocolExtensionContainer { { F-DPCH-Information-RL-SetupRqstFDD-ExtIEs } } OPTIONAL,
  ...
}

```

```

F-DPCH-Information-RL-SetupRqstFDD-ExtIEs RNSAP-PROTOCOL-EXTENSION ::= {
  ...
}

```

```

PowerOffsetInformation-F-DPCH-RL-SetupRqstFDD ::= SEQUENCE {
  po2-ForTPC-Bits PowerOffset,
  iE-Extensions ProtocolExtensionContainer { { PowerOffsetInformation-F-DPCH-RL-SetupRqstFDD-ExtIEs } } OPTIONAL,
  ...
}

```

```

PowerOffsetInformation-F-DPCH-RL-SetupRqstFDD-ExtIEs RNSAP-PROTOCOL-EXTENSION ::= {
  ...
}

```

UNCHANGED TEXT IS REMOVED

```

-- *****
--
-- RADIO LINK RECONFIGURATION PREPARE FDD
--
-- *****

RadioLinkReconfigurationPrepareFDD ::= SEQUENCE {
    protocolIEs                ProtocolIE-Container    {{RadioLinkReconfigurationPrepareFDD-IEs}},
    protocolExtensions         ProtocolExtensionContainer {{RadioLinkReconfigurationPrepareFDD-Extensions}}           OPTIONAL,
    ...
}

RadioLinkReconfigurationPrepareFDD-IEs RNSAP-PROTOCOL-IES ::= {
    { ID id-AllowedQueuingTime          CRITICALITY reject TYPE AllowedQueuingTime          PRESENCE optional } |
    { ID id-UL-DPCH-Information-RL-ReconfPrepFDD CRITICALITY reject TYPE UL-DPCH-Information-RL-ReconfPrepFDD PRESENCE optional } |
    { ID id-DL-DPCH-Information-RL-ReconfPrepFDD CRITICALITY reject TYPE DL-DPCH-Information-RL-ReconfPrepFDD PRESENCE optional } |
    { ID id-FDD-DCHs-to-Modify          CRITICALITY reject TYPE FDD-DCHs-to-Modify          PRESENCE optional } |
    { ID id-DCHs-to-Add-FDD             CRITICALITY reject TYPE DCH-FDD-Information          PRESENCE optional } |
    { ID id-DCH-DeleteList-RL-ReconfPrepFDD CRITICALITY reject TYPE DCH-DeleteList-RL-ReconfPrepFDD PRESENCE optional } |
    { ID id-DSCH-Modify-RL-ReconfPrepFDD CRITICALITY reject TYPE DSCH-Modify-RL-ReconfPrepFDD PRESENCE optional } |
    { ID id-DSCHs-to-Add-FDD            CRITICALITY reject TYPE DSCH-FDD-Information          PRESENCE optional } |
    { ID id-DSCH-Delete-RL-ReconfPrepFDD CRITICALITY reject TYPE DSCH-Delete-RL-ReconfPrepFDD PRESENCE optional } |
    { ID id-RL-InformationList-RL-ReconfPrepFDD CRITICALITY reject TYPE RL-InformationList-RL-ReconfPrepFDD PRESENCE optional } |
    { ID id-Transmission-Gap-Pattern-Sequence-Information CRITICALITY reject TYPE Transmission-Gap-Pattern-Sequence-Information PRESENCE optional }
},
    ...
}

UL-DPCH-Information-RL-ReconfPrepFDD ::= SEQUENCE {
    ul-ScramblingCode            UL-ScramblingCode            OPTIONAL,
    ul-SIRTarget                 UL-SIR                    OPTIONAL,
    minUL-ChannelisationCodeLength MinUL-ChannelisationCodeLength OPTIONAL,
    maxNrOfUL-DPDCHs            MaxNrOfUL-DPDCHs          OPTIONAL
    -- This IE shall be present if minUL-ChannelisationCodeLength equals to 4 --,
    ul-PunctureLimit            PunctureLimit            OPTIONAL,
    tFCS                         TFCS                    OPTIONAL,
    ul-DPCCH-SlotFormat          UL-DPCCH-SlotFormat      OPTIONAL,
    diversityMode                DiversityMode            OPTIONAL,
    sSDT-CellIDLength           SSDT-CellID-Length      OPTIONAL,
    s-FieldLength                S-FieldLength           OPTIONAL,
    iE-Extensions                ProtocolExtensionContainer { {UL-DPCH-Information-RL-ReconfPrepFDD-ExtIEs} } OPTIONAL,
    ...
}

UL-DPCH-Information-RL-ReconfPrepFDD-ExtIEs RNSAP-PROTOCOL-EXTENSION ::= {
    ...
}

DL-DPCH-Information-RL-ReconfPrepFDD ::= SEQUENCE {
    tFCS                         TFCS                    OPTIONAL,
    dl-DPCH-SlotFormat           DL-DPCH-SlotFormat      OPTIONAL,
    nrOfDLchannelisationcodes    NrOfDLchannelisationcodes OPTIONAL,

```

```

tFCI-SignallingMode      TFCI-SignallingMode      OPTIONAL,
tFCI-Presence            TFCI-Presence            OPTIONAL
-- This IE shall be present if DL DPCH Slot Format IE is from 12 to 16 --,
multiplexingPosition     MultiplexingPosition     OPTIONAL,
limitedPowerIncrease     LimitedPowerIncrease     OPTIONAL,
iE-Extensions           ProtocolExtensionContainer { {DL-DPCH-Information-RL-ReconfPrepFDD-ExtIEs} } OPTIONAL,
...
}

DL-DPCH-Information-RL-ReconfPrepFDD-ExtIEs RNSAP-PROTOCOL-EXTENSION ::= {
  optional { ID id-SplitType _____ CRITICALITY reject EXTENSION SplitType _____ PRESENCE
  optional } |
  { ID id-LengthOfTFCI2 _____ CRITICALITY reject EXTENSION LengthOfTFCI2 _____ PRESENCE optional } |
  { ID id-DL-DPCH-Power-Information-RL-ReconfPrepFDD CRITICALITY reject EXTENSION DL-DPCH-Power-Information-RL-ReconfPrepFDD PRESENCE optional },
  ...
}

DL-DPCH-Power-Information-RL-ReconfPrepFDD ::= SEQUENCE {
  powerOffsetInformation PowerOffsetInformation-RL-ReconfPrepFDD,
  fdd-TPC-DownlinkStepSize FDD-TPC-DownlinkStepSize,
  innerLoopDLPCStatus InnerLoopDLPCStatus,
  iE-Extensions ProtocolExtensionContainer { { DL-DPCH-Power-Information-RL-ReconfPrepFDD } } OPTIONAL,
  ...
}

DL-DPCH-Power-Information-RL-ReconfPrepFDD RNSAP-PROTOCOL-EXTENSION ::= {
  ...
}

PowerOffsetInformation-RL-ReconfPrepFDD ::= SEQUENCE {
  p01-ForTFCI-Bits PowerOffset,
  p02-ForTPC-Bits PowerOffset,
  p03-ForPilotBits PowerOffset,
  iE-Extensions ProtocolExtensionContainer { { PowerOffsetInformation-RL-ReconfPrepFDD-ExtIEs } } OPTIONAL,
  ...
}

PowerOffsetInformation-RL-ReconfPrepFDD-ExtIEs RNSAP-PROTOCOL-EXTENSION ::= {
  ...
}

DCH-DeleteList-RL-ReconfPrepFDD ::= SEQUENCE (SIZE (0..maxNrOfDCHs)) OF DCH-DeleteItem-RL-ReconfPrepFDD

DCH-DeleteItem-RL-ReconfPrepFDD ::= SEQUENCE {
  dCH-ID DCH-ID,
  iE-Extensions ProtocolExtensionContainer { {DCH-DeleteItem-RL-ReconfPrepFDD-ExtIEs} } OPTIONAL,
  ...
}

DCH-DeleteItem-RL-ReconfPrepFDD-ExtIEs RNSAP-PROTOCOL-EXTENSION ::= {
  ...
}

```

```

DSCH-Modify-RL-ReconfPrepFDD ::= SEQUENCE {
    dSCH-Information          DSCH-ModifyInfo-RL-ReconfPrepFDD    OPTIONAL,
    pdSCH-RL-ID              RL-ID                                OPTIONAL,
    tFCS                     TFCS                                OPTIONAL,
    iE-Extensions            ProtocolExtensionContainer { {DSCH-Modify-RL-ReconfPrepFDD-ExtIEs} } OPTIONAL,
    ...
}

DSCH-Modify-RL-ReconfPrepFDD-ExtIEs RNSAP-PROTOCOL-EXTENSION ::= {
    { ID id-EnhancedDSCHPCIndicator    CRITICALITY ignore  EXTENSION EnhancedDSCHPCIndicator    PRESENCE optional}|
    { ID id-EnhancedDSCHPC             CRITICALITY ignore  EXTENSION EnhancedDSCHPC             PRESENCE conditional},
    -- The IE shall be present if the Enhanced DSCH PC Indicator IE is set to "Enhanced DSCH PC Active in the UE".
    ...
}

DSCH-ModifyInfo-RL-ReconfPrepFDD ::= SEQUENCE (SIZE(0..maxNoOfDSCHs)) OF DSCH-ModifyInformationItem-RL-ReconfPrepFDD

DSCH-ModifyInformationItem-RL-ReconfPrepFDD ::= SEQUENCE {
    dSCH-ID                  DSCH-ID,
    trChSourceStatisticsDescriptor    TrCH-SrcStatisticsDescr OPTIONAL,
    transportFormatSet        TransportFormatSet            OPTIONAL,
    allocationRetentionPriority    AllocationRetentionPriority    OPTIONAL,
    schedulingPriorityIndicator    SchedulingPriorityIndicator    OPTIONAL,
    bLER                      BLER                        OPTIONAL,
    transportBearerRequestIndicator    TransportBearerRequestIndicator,
    iE-Extensions            ProtocolExtensionContainer { {DSCH-ModifyInformationItem-RL-ReconfPrepFDD-ExtIEs} } OPTIONAL,
    ...
}

DSCH-ModifyInformationItem-RL-ReconfPrepFDD-ExtIEs RNSAP-PROTOCOL-EXTENSION ::= {
    { ID id-TrafficClass          CRITICALITY ignore  EXTENSION TrafficClass          PRESENCE optional}|
    { ID id-BindingID            CRITICALITY ignore  EXTENSION BindingID            PRESENCE optional}|
    -- Shall be ignored if bearer establishment with ALCAP.
    { ID id-TransportLayerAddress    CRITICALITY ignore  EXTENSION TransportLayerAddress    PRESENCE optional },
    -- Shall be ignored if bearer establishment with ALCAP.
    ...
}

DSCH-Delete-RL-ReconfPrepFDD ::= SEQUENCE {
    dSCH-Information          DSCH-Info-Delete-RL-ReconfPrepFDD,
    iE-Extensions            ProtocolExtensionContainer { {DSCH-Delete-RL-ReconfPrepFDD-ExtIEs} } OPTIONAL,
    ...
}

DSCH-Delete-RL-ReconfPrepFDD-ExtIEs RNSAP-PROTOCOL-EXTENSION ::= {
    ...
}

DSCH-Info-Delete-RL-ReconfPrepFDD ::= SEQUENCE (SIZE(1..maxNoOfDSCHs)) OF DSCH-DeleteInformationItem-RL-ReconfPrepFDD

DSCH-DeleteInformationItem-RL-ReconfPrepFDD ::= SEQUENCE {
    dSCH-ID                  DSCH-ID,
    iE-Extensions            ProtocolExtensionContainer { {DSCH-DeleteInformationItem-RL-ReconfPrepFDD-ExtIEs} } OPTIONAL,

```

```

}
...
}
DSCH-DeleteInformationItem-RL-ReconfPrepFDD-ExtIEs RNSAP-PROTOCOL-EXTENSION ::= {
...
}
RL-InformationList-RL-ReconfPrepFDD ::= SEQUENCE (SIZE (0..maxNrOfRLs)) OF ProtocolIE-Single-Container { {RL-Information-RL-ReconfPrepFDD-IEs}
}
RL-Information-RL-ReconfPrepFDD-IEs RNSAP-PROTOCOL-IES ::= {
{ ID id-RL-Information-RL-ReconfPrepFDD CRITICALITY reject TYPE RL-Information-RL-ReconfPrepFDD PRESENCE mandatory }
}
RL-Information-RL-ReconfPrepFDD ::= SEQUENCE {
rL-ID RL-ID,
sSDT-Indication SSdT-Indication OPTIONAL,
sSDT-CellIdentity SSdT-CellID OPTIONAL
-- The IE shall be present if the sSDT-Indication is set to 'sSDT-active-in-the-UE' --,
transmitDiversityIndicator TransmitDiversityIndicator OPTIONAL,
-- This IE shall be present if Diversity Mode IE is present in UL DPCH Information IE and is not equal to "none"
iE-Extensions ProtocolExtensionContainer { {RL-Information-RL-ReconfPrepFDD-ExtIEs} } OPTIONAL,
...
}
RL-Information-RL-ReconfPrepFDD-ExtIEs RNSAP-PROTOCOL-EXTENSION ::= {
{ ID id-SSDT-CellIDforEDSCHPC CRITICALITY ignore EXTENSION SSdT-CellID PRESENCE conditional }|
-- This IE shall be present if Enhanced DSCH PC IE is present in either the DSCHs to Modify IE or the DSCHs to Add IE.
{ ID id-DLReferencePower CRITICALITY ignore EXTENSION DL-Power PRESENCE optional }|
{ ID id-RL-Specific-DCH-Info CRITICALITY ignore EXTENSION RL-Specific-DCH-Info PRESENCE optional }|
{ ID id-DL-DPCH-TimingAdjustment CRITICALITY reject EXTENSION DL-DPCH-TimingAdjustment PRESENCE optional }|
{ ID id-Qth-Parameter CRITICALITY ignore EXTENSION Qth-Parameter PRESENCE optional }|
{ ID id-Phase-Reference-Update-Indicator CRITICALITY ignore EXTENSION Phase-Reference-Update-Indicator PRESENCE optional },
...
}
RadioLinkReconfigurationPrepareFDD-Extensions RNSAP-PROTOCOL-EXTENSION ::= {
{ ID id-HSDSCH-FDD-Information CRITICALITY reject EXTENSION HSDSCH-FDD-Information PRESENCE optional }|
{ ID id-HSDSCH-Information-to-Modify CRITICALITY reject EXTENSION HSDSCH-Information-to-Modify PRESENCE optional }|
optional}|
{ ID id-HSDSCH-MACdFlows-to-Add CRITICALITY reject EXTENSION HSDSCH-MACdFlows-Information PRESENCE optional }|
{ ID id-HSDSCH-MACdFlows-to-Delete CRITICALITY reject EXTENSION HSDSCH-MACdFlows-to-Delete PRESENCE optional }|
{ ID id-HSPDSCH-RL-ID CRITICALITY reject EXTENSION RL-ID PRESENCE optional }|
optional}|
{ ID id-UE-Support-Of-Dedicated-Pilots-For-Channel-Estimation CRITICALITY ignore EXTENSION UE-Support-Of-Dedicated-Pilots-For-Channel-Estimation PRESENCE optional }|
{ ID id-UE-Support-Of-Dedicated-Pilots-For-Channel-Estimation-Of-HS-DSCH CRITICALITY ignore EXTENSION UE-Support-Of-Dedicated-Pilots-For-Channel-Estimation-Of-HS-DSCH PRESENCE optional }|
{ ID id-F-DPCH-Information-RL-ReconfPrepFDD CRITICALITY reject EXTENSION F-DPCH-Information-RL-ReconfPrepFDD PRESENCE optional },
...
}
F-DPCH-Information-RL-ReconfPrepFDD ::= SEQUENCE {

```

```

    powerOffsetInformation          PowerOffsetInformation-F-DPCH-RL-ReconfPrepFDD,
    fdd-dl-TPC-DownlinkStepSize    FDD-TPC-DownlinkStepSize,
    limitedPowerIncrease           LimitedPowerIncrease,
    innerLoopDLPCStatus            InnerLoopDLPCStatus,
    iE-Extensions                  ProtocolExtensionContainer { { F-DPCH-Information-RL-ReconfPrepFDD-ExtIEs} } OPTIONAL,
    ...
}

F-DPCH-Information-RL-ReconfPrepFDD-ExtIEs RNSAP-PROTOCOL-EXTENSION ::= {
    ...
}

PowerOffsetInformation-F-DPCH-RL-ReconfPrepFDD ::= SEQUENCE {
    po2-ForTPC-Bits                PowerOffset,
    iE-Extensions                  ProtocolExtensionContainer { { PowerOffsetInformation-F-DPCH-RL-ReconfPrepFDD-ExtIEs} } OPTIONAL,
    ...
}

PowerOffsetInformation-F-DPCH-RL-ReconfPrepFDD-ExtIEs RNSAP-PROTOCOL-EXTENSION ::= {
    ...
}

```

UNCHANGED TEXT IS REMOVED



## 9.3.4 Information Element Definitions

```

-- *****
--
-- Information Element Definitions
--
-- *****

RNSAP-IEs {
itu-t (0) identified-organization (4) etsi (0) mobileDomain (0)
umts-Access (20) modules (3) rnsap (1) version1 (1) rnsap-IEs (2) }

DEFINITIONS AUTOMATIC TAGS ::=

BEGIN

UNCHANGED TEXT IS REMOVED

-- C

Cause ::= CHOICE {
    radioNetwork      CauseRadioNetwork,
    transport         CauseTransport,
    protocol          CauseProtocol,
    misc              CauseMisc,
    ...
}

CauseMisc ::= ENUMERATED {
    control-processing-overload,
    hardware-failure,
    om-intervention,
    not-enough-user-plane-processing-resources,
    unspecified,
    ...
}

CauseProtocol ::= ENUMERATED {
    transfer-syntax-error,
    abstract-syntax-error-reject,
    abstract-syntax-error-ignore-and-notify,
    message-not-compatible-with-receiver-state,
    semantic-error,
    unspecified,
    abstract-syntax-error-falsely-constructed-message,
    ...
}

CauseRadioNetwork ::= ENUMERATED {
    unknown-C-ID,
    cell-not-available,

```

```

power-level-not-supported,
ul-scrambling-code-already-in-use,
dl-radio-resources-not-available,
ul-radio-resources-not-available,
measurement-not-supported-for-the-object,
combining-resources-not-available,
combining-not-supported,
reconfiguration-not-allowed,
requested-configuration-not-supported,
synchronisation-failure,
requested-tx-diversity-mode-not-supported,
measurement-temporarily-not-available,
unspecified,
invalid-CM-settings,
reconfiguration-CFN-not-elapsed,
number-of-DL-codes-not-supported,
dedicated-transport-channel-type-not-supported,
dl-shared-channel-type-not-supported,
ul-shared-channel-type-not-supported,
common-transport-channel-type-not-supported,
ul-spreading-factor-not-supported,
dl-spreading-factor-not-supported,
cm-not-supported,
transaction-not-supported-by-destination-node-b,
rl-already-activated-or-allocated,
...,
number-of-UL-codes-not-supported,
cell-reserved-for-operator-use,
dpc-mode-change-not-supported,
information-temporarily-not-available,
information-provision-not-supported-for-the-object,
power-balancing-status-not-compatible,
delayed-activation-not-supported,
rl-timing-adjustment-not-supported,
unknown-RNTI,
measurement-repetition-rate-not-compatible,
ue-not-capable-of-support,
harq-preamble-mode-not-supported,
f-dpch-not-supported
}

CauseTransport ::= ENUMERATED {
    transport-resource-unavailable,
    unspecified,
    ...
}

CellCapabilityContainer-FDD ::= BIT STRING (SIZE (32))
-- First bit: Flexible Hard Split Support Indicator
-- Second bit: Delayed Activation Support Indicator
-- Third bit: HS-DSCH Support Indicator
-- Fourth bit: DSCH Support Indicator
-- Fifth bit: F-DPCH Support Indicator

```

-- Note that undefined bits are considered as a spare bit and spare bits shall be set to 0 by the transmitter and shall be ignored by the receiver.

UNCHANGED TEXT IS REMOVED

## 9.3.6 Constant Definitions

```
-- *****
--
-- Constant definitions
--
-- *****

RNSAP-Constants {
itu-t (0) identified-organization (4) etsi (0) mobileDomain (0)
umts-Access (20) modules (3) rnsap (1) version1 (1) rnsap-Constants (4) }
```

DEFINITIONS AUTOMATIC TAGS ::=

BEGIN

UNCHANGED TEXT IS REMOVED

id-TraceReference	ProtocolIE-ID ::= 550
id-UEIdentity	ProtocolIE-ID ::= 551
id-NACC-Related-Data	ProtocolIE-ID ::= 552
id-GSM-Cell-InfEx-Rqst	ProtocolIE-ID ::= 553
id-MeasurementRecoveryBehavior	ProtocolIE-ID ::= 554
id-MeasurementRecoveryReportingIndicator	ProtocolIE-ID ::= 555
id-MeasurementRecoverySupportIndicator	ProtocolIE-ID ::= 556
<u>id-DL-DPCH-Power-Information-RL-ReconfPrepFDD</u>	<u>ProtocolIE-ID ::= 557</u>
<u>id-F-DPCH-Information-RL-ReconfPrepFDD</u>	<u>ProtocolIE-ID ::= 558</u>
<u>id-F-DPCH-Information-RL-SetupRqstFDD</u>	<u>ProtocolIE-ID ::= 559</u>
id-MBMS-Bearer-Service-List	ProtocolIE-ID ::= 560
id-MBMS-Bearer-Service-List-InfEx-Rsp	ProtocolIE-ID ::= 561
id-Active-MBMS-Bearer-Service-UplinkSigTrFDD	ProtocolIE-ID ::= 562
id-Active-MBMS-Bearer-Service-UplinkSigTrTDD	ProtocolIE-ID ::= 563
id-Old-URA-ID	ProtocolIE-ID ::= 564
id-TMGI	ProtocolIE-ID ::= 565
id-TransmissionMode	ProtocolIE-ID ::= 566
id-AffectedUEInformationForMBMS	ProtocolIE-ID ::= 567
id-UE-State	ProtocolIE-ID ::= 568
id-URA-ID	ProtocolIE-ID ::= 569
id-DRNC-ID	ProtocolIE-ID ::= 570
id-HARQ-Preamble-Mode	ProtocolIE-ID ::= 571

UNCHANGED TEXT IS REMOVED

## CHANGE REQUEST

# **25.430 CR 59** # rev **-** # Current version: **6.3.0** #

For **HELP** on using this form, see bottom of this page or look at the pop-up text over the # symbols.

**Proposed change affects:** UICC apps#  ME  Radio Access Network  Core Network

<b>Title:</b>	# Introduction of Fractional DPCH		
<b>Source:</b>	# RAN3		
<b>Work item code:</b>	# RANimp-RABSE-CodeOptFDD	<b>Date:</b>	# 14/02/2005
<b>Category:</b>	# <b>B</b>	<b>Release:</b>	# Rel-6
	Use <u>one</u> of the following categories:		Use <u>one</u> of the following releases:
	<b>F</b> (correction)	2	(GSM Phase 2)
	<b>A</b> (corresponds to a correction in an earlier release)	R96	(Release 1996)
	<b>B</b> (addition of feature),	R97	(Release 1997)
	<b>C</b> (functional modification of feature)	R98	(Release 1998)
	<b>D</b> (editorial modification)	R99	(Release 1999)
	Detailed explanations of the above categories can be found in 3GPP <a href="#">TR 21.900</a> .	Rel-4	(Release 4)
		Rel-5	(Release 5)
		Rel-6	(Release 6)

<b>Reason for change:</b>	# Introduction of the Fractional DPCH functionality over the lur.
<b>Summary of change:</b>	# Introduction of the Fractional DPCH functionality over the lur.
<b>Consequences if not approved:</b>	# Fractional DPCH will not be included in the specifications.

<b>Clauses affected:</b>	# 3.2, 6.1								
<b>Other specs</b>	<table border="1" style="border-collapse: collapse;"> <tr> <td style="width: 20px; height: 20px;"></td> <td style="width: 20px; height: 20px; text-align: center;">Y</td> <td style="width: 20px; height: 20px; text-align: center;">N</td> </tr> <tr> <td style="text-align: center;">X</td> <td style="text-align: center;"> </td> <td style="text-align: center;"> </td> </tr> </table>		Y	N	X			Other core specifications	# CR 194 on 25.211 v 6.3.0 CR 193 on 25.212 v 6.3.0 CR 70 on 25.213 v 6.1.0 CR 357 on 25.214 v 6.4.0 CR 148 on 25.215 v 6.1.0 CR 46 on 25.402 v 6.1.0 CR 47 on 25.420 v 6.2.0 CR 1036 on 25.423 v 6.4.1 CR 1082 on 25.433 v 6.4.0
	Y	N							
X									
<b>affected:</b>	<table border="1" style="border-collapse: collapse;"> <tr> <td style="width: 20px; height: 20px;"></td> <td style="width: 20px; height: 20px; text-align: center;">X</td> </tr> <tr> <td style="width: 20px; height: 20px;"></td> <td style="width: 20px; height: 20px; text-align: center;">X</td> </tr> </table>		X		X	Test specifications O&M Specifications			
	X								
	X								
<b>Other comments:</b>	#								

**How to create CRs using this form:**

Comprehensive information and tips about how to create CRs can be found at <http://www.3gpp.org/specs/CR.htm>. Below is a brief summary:

- 1) Fill out the above form. The symbols above marked ⌘ contain pop-up help information about the field that they are closest to.
- 2) Obtain the latest version for the release of the specification to which the change is proposed. Use the MS Word "revision marks" feature (also known as "track changes") when making the changes. All 3GPP specifications can be downloaded from the 3GPP server under <ftp://ftp.3gpp.org/specs/> For the latest version, look for the directory name with the latest date e.g. 2001-03 contains the specifications resulting from the March 2001 TSG meetings.
- 3) With "track changes" disabled, paste the entire CR form (use CTRL-A to select it) into the specification just in front of the clause containing the first piece of changed text. Delete those parts of the specification which are not relevant to the change request.

## 3.2 Abbreviations

For the purposes of the present document, the following abbreviations apply:

AAL2	ATM Adaptation Layer type 2
AAL5	ATM Adaptation Layer type 5
AICH	Acquisition Indication Channel
ALCAP	Access Link Control Application Part
AP-AICH	Access Preamble Acquisition Indication Channel
ATM	Asynchronous Transfer Mode
BCH	Broadcast Channel
BCCH	Broadcast Control Channel
CCH	Control Channel
CD/CA-ICH	Collision Detection/Channel Assignment Indication Channel
CPCH	Common Packet Channel
CPCId	Common Physical Channel Identifier
CPICH	Common Pilot Channel
CSICH	Common Packet Channel Status Indication Channel
CTCId	Common Transport Channel Identifier
CRNC	Controlling Radio Network Controller
DCH	Dedicated Transport Channel
DPCCH	Dedicated Physical Control Channel
DPCH	Dedicated Physical Channel
DRNC	Drift Radio Network Controller
DSCH	Down-link Shared Channel
E-DCH	Enhanced Dedicated Channel
FACH	Forward Access Channel
FAUSCH	Fast Up-link Signalling Channel
FDD	Frequency Division Duplex
<u>F-DPCH</u>	<u>Fractional DPCH</u>
FP	Frame Protocol
HARQ	Hybrid Automatic Repeat Request
HS-DSCH	High Speed Downlink Shared Channel
IP	Internet Protocol
MICH	MBMS notification Indicator Channel
NBAP	Node B Application Part
O&M	Operation and Maintenance
PICH	Page Indication Channel
PCCH	Paging Control Channel
PCCPCH	Primary Common Control Physical Channel
PCPCH	Physical Common Packet Channel
PCPICH	Primary Common Pilot Channel
PCH	Paging Channel
PDSCH	Physical Downlink Shared Channel
PRACH	Physical Random Access Channel
PUSCH	Physical Uplink Shared Channel
RACH	Random Access Channel
RNC	Radio Network Controller
RNS	Radio Network Subsystem
SCCP	Signalling Connection Control Part
SCH	Synchronization Channel
SCCPCH	Secondary Common Control Physical Channel
SCPICH	Secondary Common Pilot Channel
SCTP	Stream Control Transmission Protocol
SRNC	Serving Radio Network Controller
SSCF-UNI	Service Specific Co-ordination Function - User Network Interface
SSCOP	Service Specific Connection Oriented Protocol
TDD	Time Division Duplex
UE	User Equipment
UC-ID	UTRAN Cell Identifier
UDP	User Datagram Protocol

UMTS	Universal Mobile Telecommunication System
USCH	Up-link Shared Channel
UTRAN	UMTS Terrestrial Radio Access Network



## 6.1 Overview

The model described in figure 2 shows the Node B as seen from the controlling RNC. The model includes:

- The logical resources provided by Node B to UTRAN (via its Controlling RNC) - depicted as "cells" which include the physical channel resources DPCH, [FDD – F-DPCH](#), PDSCH, and PUSCH;
- The dedicated channels which have been established on Node B;
- The common transport channels that Node B provides to the RNC.

The procedures for controlling the connections between radio links and Iub DCH data ports are sent from the RNC to the Node B via the Communication Control Ports.

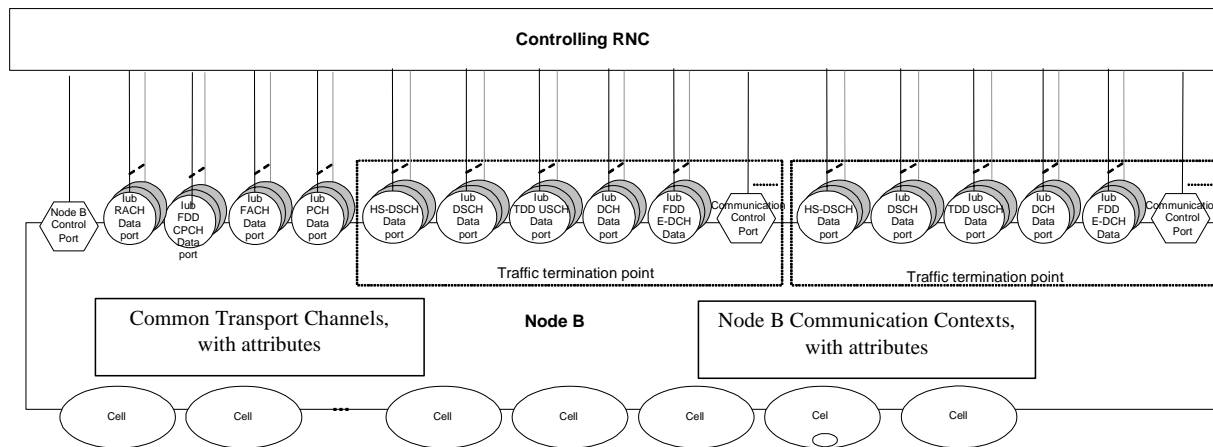

**Figure 2: Logical Model of Node B**

## CHANGE REQUEST

# 25.433 CR 1082 # rev 1 # Current version: 6.4.0 #

For **HELP** on using this form, see bottom of this page or look at the pop-up text over the # symbols.

**Proposed change affects:** UICC apps  ME  Radio Access Network  Core Network

<b>Title:</b>	# Introduction of Fractional DPCH		
<b>Source:</b>	# RAN3		
<b>Work item code:</b>	# RANimp-RABSE-CodeOptFDD	<b>Date:</b>	# 14/02/2005
<b>Category:</b>	# <b>B</b>	<b>Release:</b>	# Rel-6
	Use <u>one</u> of the following categories: <b>F</b> (correction) <b>A</b> (corresponds to a correction in an earlier release) <b>B</b> (addition of feature), <b>C</b> (functional modification of feature) <b>D</b> (editorial modification) Detailed explanations of the above categories can be found in 3GPP <a href="#">TR 21.900</a> .		Use <u>one</u> of the following releases: Ph2 (GSM Phase 2) R96 (Release 1996) R97 (Release 1997) R98 (Release 1998) R99 (Release 1999) Rel-4 (Release 4) Rel-5 (Release 5) Rel-6 (Release 6) Rel-7 (Release 7)

<b>Reason for change:</b>	# Introduction of the Fractional DPCH functionality over the lub.
<b>Summary of change:</b>	# Rev 1: Updates to introduce the "alternative" solution in replacement of the default solution. Rev 0: Introduction of the Fractional DPCH functionality in RNSAP based on the default solution.
<b>Consequences if not approved:</b>	# Fractional DPCH will not be included in the specifications.

<b>Clauses affected:</b>	# 3.3, 8.2.17.2, 8.2.17.3, 8.2.17.4, 8.3.1.2, 8.3.1.4, 8.3.2.2, 8.3.2.3, 8.3.2.4, 8.3.3.2, 8.3.5.2, 8.3.5.4, 8.3.14.2, 8.3.18.2, 9.1.36.1, 9.1.39.1, 9.1.42.1, 9.1.47.1, 9.1.51, 9.2.1.6, 9.2.1.21, 9.2.2.2, 9.2.2.12B, 9.2.2.29, 9.3.3, 9.3.4, 9.3.6						
<b>Other specs</b>	<table border="1" style="display: inline-table; vertical-align: middle;"> <tr> <td style="width: 20px; height: 20px; text-align: center;">Y</td> <td style="width: 20px; height: 20px; text-align: center;">N</td> </tr> <tr> <td style="text-align: center;">X</td> <td></td> </tr> </table> Other core specifications	Y	N	X		#	CR 194 on 25.211 v 6.3.0 CR 193 on 25.212 v 6.3.0 CR 70 on 25.213 v 6.1.0 CR 357 on 25.214 v 6.4.0 CR 148 on 25.215 v 6.1.0 CR 46 on 25.402 v 6.1.0 CR 47 on 25.420 v 6.2.0 CR 1036 on 25.423 v 6.4.1 CR 59 on 25.430 v 6.3.0
Y	N						
X							
<b>affected:</b>	<table border="1" style="display: inline-table; vertical-align: middle;"> <tr> <td style="width: 20px; height: 20px; text-align: center;">Y</td> <td style="width: 20px; height: 20px; text-align: center;">N</td> </tr> <tr> <td></td> <td style="text-align: center;">X</td> </tr> </table> Test specifications	Y	N		X		
Y	N						
	X						

**Other comments:** ☹

**How to create CRs using this form:**

Comprehensive information and tips about how to create CRs can be found at <http://www.3gpp.org/specs/CR.htm>. Below is a brief summary:

- 1) Fill out the above form. The symbols above marked ☹ contain pop-up help information about the field that they are closest to.
- 2) Obtain the latest version for the release of the specification to which the change is proposed. Use the MS Word "revision marks" feature (also known as "track changes") when making the changes. All 3GPP specifications can be downloaded from the 3GPP server under <ftp://ftp.3gpp.org/specs/> For the latest version, look for the directory name with the latest date e.g. 2001-03 contains the specifications resulting from the March 2001 TSG meetings.
- 3) With "track changes" disabled, paste the entire CR form (use CTRL-A to select it) into the specification just in front of the clause containing the first piece of changed text. Delete those parts of the specification which are not relevant to the change request.

### 3.3 Abbreviations

For the purposes of the present document, the following abbreviations apply:

A-GPS	Assisted GPS
AICH	Acquisition Indicator Channel
ALCAP	Access Link Control Application Part
AP-AICH	Access Preamble Acquisition Indicator Channel
ASN.1	Abstract Syntax Notation One
BCCH	Broadcast Control Channel
CCPCH	Common Control Physical Channel
CFN	Connection Frame Number
CM	Compressed Mode
CPCH	Common Packet Channel
CPICH	Common Pilot Channel
CRNC	Controlling Radio Network Controller
CSICH	CPCH Status Indicator Channel
DCH	Dedicated Channel
DGPS	Differential GPS
DL	Downlink
DPCCH	Dedicated Physical Control Channel
DPCH	Dedicated Physical Channel
DPDCH	Dedicated Physical Data Channel
DSCH	Downlink Shared Channel
E-DCH	Enhanced UL DCH
FACH	Forward Access Channel
FDD	Frequency Division Duplex
<a href="#">F-DPCH</a>	<a href="#">Fractional DPCH</a>
FP	Frame Protocol
GPS	Global Positioning System
HSDPA	High Speed Downlink Packet Access
HS-DSCH	High Speed Downlink Shared Channel
HS-PDSCH	High Speed Physical Downlink Shared Channel
HS-SCCH	High Speed Shared Control Channel
HS-SICH	High Speed Shared Information Channel
IP	Internet Protocol
IPDL	Idle Periods in the DownLink
ISCP	Interference Signal Code Power
L1	Layer 1
L2	Layer 2
MIB	Master Information Block
MICH	MBMS Notification Indicator Channel
NBAP	Node B Application Part
NI	MBMS Notification Indicator
O&M	Operation and Maintenance
PCCPCH	Primary Common Control Physical Channel
PCH	Paging Channel
PCPCH	Physical Common Packet Channel
PDSCH	Physical Downlink Shared Channel
PICH	Paging Indication Channel
PUSCH	Physical Uplink Shared Channel
RACH	Random Access Channel
RL	Radio Link
RLS	Radio Link Set
RNC	Radio Network Controller
RRC	Radio Resource Control
SB	Scheduling Block
SCCPCH	Secondary Common Control Physical Channel
SCH	Synchronisation Channel
SCTD	Space Code Transmit Diversity
SIB	System Information Block

SRNC	Serving Radio Network Controller
SSDT	Site Selection Diversity Transmission
STTD	Space Time Transmit Diversity
TDD	Time Division Duplex
TFC	Transport Format Combination
TFCI	Transport Format Combination Indicator
TFCS	Transport Format Combination Set
TFS	Transport Format Set
TPC	Transmit Power Control
TSTD	Time Switched Transmit Diversity
UARFCN	UTRA Absolute Radio Frequency Channel Number
UDP	User Datagram Protocol
UE	User Equipment
UL	Uplink
UMTS	Universal Mobile Telecommunications System
USCH	Uplink Shared Channel
UTRA	Universal Terrestrial Radio Access
UTRAN	Universal Terrestrial Radio Access Network

## 8.2.17 Radio Link Setup

### 8.2.17.1 General

This procedure is used for establishing the necessary resources for a new Node B Communication Context in the Node B.

[FDD - The Radio Link Setup procedure is used to establish one or more radio links. The procedure establishes one or more DCHs on all radio links, and in addition, it can include the establishment of one or more DSCHs or an HS-DSCH on one radio link.]

[TDD - The Radio Link Setup procedure is used to establish one radio link including one or more transport channels. The transport channels can be a mix of DCHs, DSCHs, and USCHs, or DCHs and an HS-DSCH, including also combinations where one or more transport channel types are not present.]

### 8.2.17.2 Successful Operation

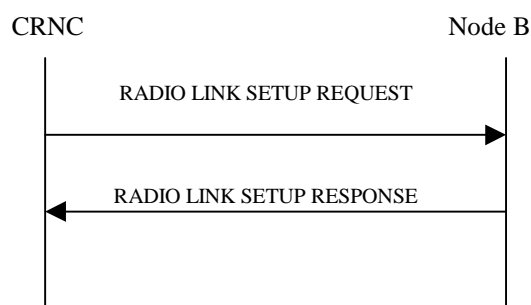

**Figure 24: Radio Link Setup procedure, Successful Operation**

The procedure is initiated with a RADIO LINK SETUP REQUEST message sent from the CRNC to the Node B using the Node B Control Port.

Upon reception of the RADIO LINK SETUP REQUEST message, the Node B shall reserve necessary resources and configure the new Radio Link(s) according to the parameters given in the message.

The Node B shall prioritise resource allocation for the RL(s) to be established according to Annex A.

#### Transport Channels Handling:

##### DCH(s):

[TDD - If the *DCH Information* IE is present, the Node B shall configure the new DCH(s) according to the parameters given in the message.]

If the RADIO LINK SETUP REQUEST message includes a *DCH Information* IE with multiple *DCH Specific Info* IEs, then the Node B shall treat the DCHs in the *DCH Information* IE as a set of co-ordinated DCHs. The Node B shall include these DCHs in the new configuration only if it can include all of them in the new configuration.

If the *DCH Specific Info* IE includes the *Unidirectional DCH Indicator* IE set to "Uplink DCH only", the Node B shall ignore the *Transport Format Set* IE for the downlink for this DCH. As a consequence this DCH is not included as a part of the downlink CCTrCH.

[TDD - If the *DCH Specific Info* IE includes the *Unidirectional DCH Indicator* IE set to "Downlink DCH only", the Node B shall ignore the *Transport Format Set* IE for the uplink for this DCH. As a consequence this DCH is not included as a part of the uplink CCTrCH.]

[FDD - For DCHs which do not belong to a set of co-ordinated DCHs with the *QE-Selector* IE set to "selected", the Transport channel BER from that DCH shall be the base for the QE in the UL data frames. If no Transport channel BER is available for the selected DCH, the Physical channel BER shall be used for the QE, ref. [16]. If the *QE-Selector* IE is set to "non-selected", the Physical channel BER shall be used for the QE in the UL data frames, ref. [16].]

For a set of co-ordinated DCHs, the Transport channel BER from the DCH with the *QE-Selector* IE set to "selected" shall be used for the QE in the UL data frames, ref. [16]. [FDD - If no Transport channel BER is available for the selected DCH, the Physical channel BER shall be used for the QE, ref. [16]. If all DCHs have *QE-Selector* IE set to "non-selected", the Physical channel BER shall be used for the QE, ref. [16]].

The Node B shall use the included *UL FP Mode* IE for a DCH or a set of co-ordinated DCHs as the FP Mode in the Uplink of the user plane for the DCH or the set of co-ordinated DCHs in the configuration.

The Node B shall use the included *ToAWS* IE for a DCH or a set of co-ordinated DCHs as the Time of Arrival Window Startpoint in the user plane for the DCH or the set of co-ordinated DCHs in the configuration.

The Node B shall use the included *ToAWE* IE for a DCH or a set of co-ordinated DCHs as the Time of Arrival Window Endpoint in the user plane for the DCH or the set of co-ordinated DCHs in the configuration.

The received *Frame Handling Priority* IE specified for each Transport Channel should be used when prioritising between different frames in the downlink on the radio interface in congestion situations within the Node B once the new RL(s) has been activated.

If the *TNL QoS* IE is included for a DCH or a set of co-ordinated DCHs and if ALCAP is not used, the *TNL QoS* IE may be used by the Node B to determine the transport bearer characteristics to apply in the uplink between the Node B and the CRNC for the related DCH or set of co-ordinated DCHs.

[FDD - The *Diversity Control Field* IE indicates for each RL (except the first RL in the message) whether the Node B shall combine the concerned RL or not.

- If the *Diversity Control Field* IE is set to "May", the Node B shall decide for either of the alternatives.
- If the *Diversity Control Field* IE is set to "Must", the Node B shall combine the RL with one of the other RL.
- If the *Diversity Control Field* IE is set to "Must not", the Node B shall not combine the RL with any other existing RL.

The *Diversity Control Field* IE is applied to Dedicated Transport Channels (DCH) only, in case of E-DCH it shall always be assumed to be set to "Must". When a new RL is to be combined, the Node B shall choose which RL(s) to combine it with.]

[FDD - In the RADIO LINK SETUP RESPONSE message, the Node B shall indicate for each RL with the Diversity Indication in the *RL Information Response* IE whether the RL is combined or not.]

- [FDD - In case of not combining with a RL previously listed in the RADIO LINK SETUP RESPONSE message or for the first RL in the RADIO LINK SETUP RESPONSE message, the Node B shall include in the *DCH Information Response* IE in the RADIO LINK SETUP RESPONSE message the *Binding ID* IE and *Transport Layer Address* IE for the transport bearer to be established for each DCH of this RL.]
- [FDD - Otherwise in case of combining, the *RL ID* IE indicates (one of) the RL(s) previously listed in this RADIO LINK SETUP RESPONSE message with which the concerned RL is combined.]

[TDD - The Node B shall include in the *DCH Information Response* IE in the RADIO LINK SETUP RESPONSE message the *Binding ID* IE and *Transport Layer Address* IE for the transport bearer to be established for each DCH of this RL.]

In the case of a set of co-ordinated DCHs, the *Binding ID* IE and the *Transport Layer Address* IE shall be specified for only one of the DCHs in the set of co-ordinated DCHs.

#### **DSCH(s):**

If the *DSCH Information* IE is present, the Node B shall configure the new DSCH(s) according to the parameters given in the message.

[FDD - If the RADIO LINK SETUP REQUEST message includes the *TFCI2 Bearer Information* IE then the Node B shall support the establishment of a transport bearer on which the DSCH TFCI Signaling control frames shall be received. The Node B shall manage the time of arrival of these frames according to the values of ToAWS and ToAWE specified in the IEs. The *TFCI2 Bearer Information Response* IE containing the

*Binding ID* IE and the *Transport Layer Address* IE for the new bearer to be set up for this purpose shall be returned in the RADIO LINK SETUP RESPONSE message. If the RADIO LINK SETUP REQUEST message includes the *Transport Layer Address* IE and *Binding ID* IE in the *TFCI2 Bearer Information* IE the Node B may use the transport layer address and the binding identifier received from the CRNC when establishing a TFCI2 transport bearer.]

If the RADIO LINK SETUP REQUEST message includes the *Transport Layer Address* IE and *Binding ID* IE in the *DSCH Information* IE, the Node B may use the transport layer address and the binding identifier received from the CRNC when establishing a transport bearer for the DSCH.

The Node B shall include in the *DSCH Information Response* IE in the RADIO LINK SETUP RESPONSE the *Binding ID* IE and the *Transport Layer Address* IE for the transport bearer to be established for each DSCH of this RL.

#### **[TDD - USCH(s)]:**

[TDD - If the *USCH Information* IE is present, the Node B shall configure the new USCH(s) according to the parameters given in the message.]

[TDD - If the RADIO LINK SETUP REQUEST message includes the *Transport Layer Address* IE and *Binding ID* IE in the *USCH Information* IE, the Node B may use the transport layer address and the binding identifier received from the CRNC when establishing a transport bearer for the USCH.]

[TDD - If the RADIO LINK SETUP REQUEST message includes the *TNL QoS* IE in the *USCH Information* IE and if ALCAP is not used, the Node B may use the *TNL QoS* IE to determine the transport bearer characteristics to apply in the uplink for the related USCH.]

[TDD - If the *USCH Information* IE is present, the Node B shall include in the *USCH Information Response* IE in the RADIO LINK SETUP RESPONSE message the *Binding ID* IE and the *Transport Layer Address* IE for the transport bearer to be established for each USCH of this RL.]

#### **HS-DSCH:**

If the *HS-DSCH Information* IE is present in the RADIO LINK SETUP REQUEST message, then:

- The Node B shall setup the requested HS-PDSCH resources on the Serving HS-DSCH Radio Link indicated by the *HS-PDSCH RL ID* IE.
- The Node B shall include the *HARQ Memory Partitioning* IE in the [FDD – *HS-DSCH FDD Information Response* IE] [TDD – *HS-DSCH TDD Information Response* IE] in the RADIO LINK SETUP RESPONSE message.
- The Node B shall include in the RADIO LINK SETUP RESPONSE message the *Binding ID* IE and *Transport Layer Address* IE for establishment of transport bearer for every HS-DSCH MAC-d flow being established.
- If the RADIO LINK SETUP REQUEST message includes the *Transport Layer Address* IE and *Binding ID* IE in the *HS-DSCH Information* IE for an HS-DSCH MAC-d flow, then the Node B may use the transport layer address and the binding identifier received from the CRNC when establishing a transport bearer for the concerned HS-DSCH MAC-d flow.
- If the RADIO LINK SETUP REQUEST message includes the *MAC-hs Guaranteed Bit Rate* IE for a Priority Queue in the *HS-DSCH MAC-d Flows Information* IE in the *HS-DSCH Information* IE, then the Node B shall use this information to optimise MAC-hs scheduling decisions for the related HSDPA Priority Queue.
- If the RADIO LINK SETUP REQUEST message includes the *Discard Timer* IE for a Priority Queue in the *HS-DSCH MAC-d Flows Information* IE in the *HS-DSCH Information* IE, then the Node B shall use this information to discard out-of-date MAC-hs SDUs from the related HSDPA Priority Queue.
- The Node B shall include the *HS-DSCH Initial Capacity Allocation* IE in the [FDD – *HS-DSCH FDD Information Response* IE] [TDD – *HS-DSCH TDD Information Response* IE] in the RADIO LINK SETUP RESPONSE message for every HS-DSCH MAC-d flow being established, if the Node B allows the CRNC to start transmission of MAC-d PDUs before the Node B has allocated capacity on user plane as described in [24].



- [FDD – If the RADIO LINK SETUP REQUEST message includes the *HS-SCCH Power Offset* IE in the *HS-DSCH Information* IE, then the Node B may use this value to determine the HS-SCCH power. The HS-SCCH Power Offset should be applied for any HS-SCCH transmission to this UE.]
- [FDD – If the RADIO LINK SETUP REQUEST message includes the *Measurement Power Offset* IE in the *HS-DSCH Information* IE, then the Node B shall use the measurement power offset as described in ref [10], subclause 6A.2.]
- [FDD – The Node B shall allocate HS-SCCH codes corresponding to the HS-DSCH and include the *HS-SCCH Specific Information Response* IE in the *HS-DSCH FDD Information Response* IE in the RADIO LINK SETUP RESPONSE message.]
- [TDD – The Node B shall allocate HS-SCCH parameters corresponding to the HS-DSCH and include the [3.84Mcps TDD - *HS-SCCH Specific Information Response* IE] [1.28Mcps TDD - *HS-SCCH Specific Information Response LCR* IE] in the *HS-DSCH TDD Information Response* IE in the RADIO LINK SETUP RESPONSE message.]
- [FDD – If the RADIO LINK SETUP REQUEST message includes the *HARQ Preamble Mode* IE in the *HS-DSCH Information* IE, then the Node B shall use the indicated HARQ Preamble Mode as described in [10].]

**[FDD - E-DCH]:**

[FDD – If the *E-DCH FDD Information* IE is present in the RADIO LINK SETUP REQUEST message:]

- [FDD – The Node B shall setup the requested E-DCH resources on the Radio Links indicated by the *E-DCH RL Indication* IE in the *RL Information* IE.]
- [FDD – The Node B shall include in the RADIO LINK SETUP RESPONSE message the *Binding ID* IE and *Transport Layer Address* IE for establishment of transport bearer for every E-DCH MAC-d flow being established.]
- [FDD – If the RADIO LINK SETUP REQUEST message includes the *Transport Layer Address* IE and *Binding ID* IE in the *E-DCH Information* IE for an E-DCH MAC-d flow, then the Node B may use the transport layer address and the binding identifier received from the CRNC when establishing a transport bearer for the concerned E-DCH MAC-d flow.]
- [FDD – If the RADIO LINK SETUP REQUEST message includes the *MAC-es Guaranteed Bit Rate* IE in the *Data Descriptor Indicator* IE in the *E-DCH Information* IE, then the Node B shall use this information to optimise MAC-e scheduling decisions for the related reordering queue.]
- [FDD – If the RADIO LINK SETUP REQUEST message includes the *Maximum Number Of Transmissions For E-DCH* IE in the *E-DCH FDD Information* IE, then the Node B shall use this information to report if the maximum number of transmissions has elapsed.]
- [FDD – If the *TNL QoS* IE is included for an E-DCH MAC-d flow and if ALCAP is not used, the *TNL QoS* IE may be used by the Node B to determine the transport bearer characteristics to apply in the uplink for the related MAC-d flow.]
- [FDD – The Node B shall include the *E-AGCH And E-RGCH/E-HICH FDD Scrambling Code* IE, the *E-RGCH/E-HICH Channelisation Code* IE and the corresponding *Sequence Number* IEs in the *E-DCH FDD DL Control Channel Information* IE in the RADIO LINK SETUP RESPONSE message for every RL indicated by the *E-DCH RL Indication* IE in the *RL Information* IE.]
- [FDD – If the RADIO LINK SETUP message includes the *Serving E-DCH RL* IE indicating that the Serving E-DCH RL is in this Node B, then the Node B shall allocate an E-RNTI identifier for the corresponding RL and include this E-RNTI identifier and the channelisation code of the corresponding E-AGCH in the *E-DCH FDD DL Control Channel Information* IE in the RADIO LINK SETUP RESPONSE message.]

**Physical Channels Handling:**

**[FDD - Compressed Mode]:**

[FDD - If the RADIO LINK SETUP REQUEST message includes the *Transmission Gap Pattern Sequence Information IE*, the Node B shall store the information about the Transmission Gap Pattern Sequences to be used in the Compressed Mode Configuration. This Compressed Mode Configuration shall be valid in the Node B until the next Compressed Mode Configuration is configured in the Node B or the Node B Communication Context is deleted.]

[FDD - If the *Downlink Compressed Mode Method IE* in one or more Transmission Gap Pattern Sequence is set to "SF/2" in the RADIO LINK SETUP REQUEST message, the Node B shall use or not the alternate scrambling code as indicated for each DL Channelisation Code in the *Transmission Gap Pattern Sequence Code Information IE*.]

[FDD - If the RADIO LINK SETUP REQUEST message includes the *Transmission Gap Pattern Sequence Information IE* and the *Active Pattern Sequence Information IE*, the Node B shall use the information to activate the indicated Transmission Gap Pattern Sequence(s) in the new RL. The received *CM Configuration Change CFN* refers to the latest passed CFN with that value. The Node B shall treat the received *TGCFN* IEs as follows:]

- [FDD - If any received *TGCFN IE* has the same value as the received *CM Configuration Change CFN IE*, the Node B shall consider the concerned Transmission Gap Pattern Sequence as activated at that CFN.]
- [FDD - If any received *TGCFN IE* does not have the same value as the received *CM Configuration Change CFN IE* but the first CFN after the *CM Configuration Change CFN* with a value equal to the *TGCFN IE* has already passed, the Node B shall consider the concerned Transmission Gap Pattern Sequence as activated at that CFN.]
- [FDD - For all other Transmission Gap Pattern Sequences included in the *Active Pattern Sequence Information IE*, the Node B shall activate each Transmission Gap Pattern Sequence at the first CFN after the *CM Configuration Change CFN* with a value equal to the *TGCFN IE* for the Transmission Gap Pattern Sequence.]

[FDD - If the RADIO LINK SETUP REQUEST message includes the *Transmission Gap Pattern Sequence Information IE* and the *Active Pattern Sequence Information IE* and the concerned Node B Communication Context is configured to use F-DPCH in the downlink, the Node B shall ignore, when activating the Transmission Gap Pattern Sequence(s), the information provided by the *Downlink Compressed Mode Method IE* if included for the concerned Transmission Gap Pattern Sequence(s).]

#### [FDD - DL Code Information]:

[FDD - When more than one DL DPDCH is assigned per RL, the segmented physical channel shall be mapped on to DL DPDCHs according to [8]. When  $p$  number of DL DPDCHs are assigned to each RL, the first pair of DL Scrambling Code and FDD DL Channelisation Code Number corresponds to "*PhCH number 1*", the second to "*PhCH number 2*", and so on until the  $p$ th to "*PhCH number p*".]

#### [TDD - PDSCH RL ID]:

[TDD - If the *PDSCH RL ID IE* is included in RADIO LINK SETUP REQUEST message, the Node B shall use the PDSCH RL ID as an identifier for the PDSCH and/or PUSCH in this radio link.]

#### [FDD – Phase Reference Handling]:

[FDD – If the RADIO LINK SETUP REQUEST message includes the *Primary CPICH Usage For Channel Estimation IE* and has the value "Primary CPICH shall not be used", the Node B shall assume that the UE is not using the Primary CPICH for channel estimation. If the RADIO LINK SETUP REQUEST message does not include the *Primary CPICH Usage For Channel Estimation IE* or includes the *Primary CPICH Usage For Channel Estimation IE* and has the value "Primary CPICH may be used", the Node B shall assume that the UE may use the Primary CPICH for channel estimation.]

[FDD – If the RADIO LINK SETUP REQUEST message includes the *Secondary CPICH Information IE*, the Node B shall assume that the UE may use the Secondary CPICH indicated by the *Common Physical Channel ID IE* for channel estimation.]

#### General:

[FDD - If the *Propagation Delay IE* is included, the Node B may use this information to speed up the detection of L1 synchronisation.]

[FDD - The *UL SIR Target* IE included in the message shall be used by the Node B as initial UL SIR target for the UL inner loop power control.]

[1.28Mcps TDD - The *UL SIR Target* IE included in the message shall be used by the Node B as initial UL SIR target for the UL inner loop power control according [19] and [21].]

[FDD - If the received *Limited Power Increase* IE is set to "Used", the Node B shall, if supported, use Limited Power Increase according to ref. [10] subclause 5.2.1 for the inner loop DL power control.]

[FDD - If the *TFCI Signalling Mode* IE within the RADIO LINK SETUP REQUEST message indicates that there shall be a hard split on the TFCI field but the *TFCI2 Bearer Information* IE is not included in the message, then the Node B shall transmit the TFCI2 field with zero power.]

[FDD - If the *TFCI Signalling Mode* IE within the RADIO LINK SETUP REQUEST message indicates that there shall be a hard split on the TFCI and the *TFCI2 Bearer Information* IE is included in the message, then the Node B shall transmit the TFCI2 field with zero power until Synchronization is achieved on the TFCI2 transport bearer and the first valid DSCH TFCI Signalling control frame is received on this bearer (see ref. [24]).]

[FDD - If the RADIO LINK SETUP REQUEST message includes the *Length Of TFCI2* IE, then the Node B shall apply the length of TFCI (field 2) indicated in the message.]

[FDD - If the RADIO LINK SETUP REQUEST message does not include the *Length Of TFCI2* IE and the *Split Type* IE is present with the value "Hard", then the Node B shall assume the length of the TFCI (field 2) is 5 bits.]

[1.28Mcps TDD - If the *UL CTrCH Information* IE includes the *TDD TPC UL Step Size* IE, the Node B shall configure the uplink TPC step size according to the parameters given in the message.]

#### **[FDD - E-DPCH Handling]:**

[FDD – If the *UL DPDCH Indicator For E-DCH Operation* IE is set to "UL DPDCH not present", the *Min UL Channelisation Code Length* IE, the *Puncture Limit* IE and the *TFCS* IE within the *UL DPCH Information* IE shall be ignored.]

[\[FDD – If the RADIO LINK SETUP REQUEST message includes the \*DL DPCH Information\* IE, then the Node B shall configure the concerned Node B Communication Context to use DPCH in the downlink, i.e. with a DL DPCCCH and a DL DPDCH.\]](#)

[\[FDD – If the RADIO LINK SETUP REQUEST message includes the \*F-DPCH Information\* IE, then the Node B shall configure the concerned Node B Communication Context to use F-DPCH in the downlink, i.e. with transmission of only the TPC field.\]](#)

#### **Radio Link Handling:**

##### **[FDD - Transmit Diversity]:**

[FDD - When the *Diversity Mode* IE is set to "STTD", "Closedloop mode1" or "Closedloop mode2", the Node B shall activate/deactivate the Transmit Diversity for each Radio Link in accordance with the *Transmit Diversity Indication* IE]

##### **DL Power Control:**

[FDD - The Node B shall start any DL transmission using the initial DL power specified in the message on each DL DPCH [or on the F-DPCH](#) of the RL until either UL synchronisation on the Uu interface is achieved for the RLS or Power Balancing is activated. No inner loop power control or balancing shall be performed during this period. The DL power shall then vary according to the inner loop power control (see ref.[10], subclause 5.2.1.2) and the power control procedure (see subclause 8.3.7), but shall always be kept within the maximum and minimum limit specified in the RADIO LINK SETUP REQUEST message. [If the Node B Communication Context is configured to use DPCH in the downlink](#), ~~d~~during compressed mode, the  $\delta P_{curr}$ , as described in ref.[10] subclause 5.2.1.3, shall be added to the maximum DL power for the associated compressed frame.]

[FDD - If the *DPC Mode* IE is present in the RADIO LINK SETUP REQUEST message, the Node B shall apply the DPC mode indicated in the message and be prepared that the DPC mode may be changed during

the lifetime of the RL. If the *DPC Mode* IE is not present in the RADIO LINK SETUP REQUEST message, DPC mode 0 shall be applied (see ref. [10]).]

[3.84 Mcps TDD - The Node B shall determine the initial CCTrCH DL power for each DCH type CCTrCH by the following rule: If the *CCTrCH Initial DL Transmission Power* IE is included for that CCTrCH, then the Node B shall use that power for the initial CCTrCH DL power, otherwise the initial CCTrCH DL power is the *Initial DL Transmission Power* IE included in the *RL Information* IE. The Node B shall start any DL transmission on each DCH type CCTrCH using the initial CCTrCH DL power, as determined above, on each DL DPCH and on each Time Slot of the CCTrCH until the UL synchronisation on the Uu interface is achieved for the CCTrCH. No inner loop power control shall be performed during this period. The DL power shall then vary according to the inner loop power control (see ref.[21], subclause 4.2.3.4), but shall always be kept within the maximum and minimum limit specified in the RADIO LINK SETUP REQUEST message.]

[3.84 Mcps TDD - The Node B shall determine the maximum DL power for each DCH type CCTrCH by the following rule: If the *CCTrCH Maximum DL Transmission Power* IE is included for that CCTrCH, then the Node B shall use that power for the maximum DL power, otherwise the maximum DL power is the *Maximum DL Power* IE included in the *RL Information* IE.]

[3.84 Mcps TDD - The Node B shall determine the minimum DL power for each DCH type CCTrCH by the following rule: If the *CCTrCH Minimum DL Transmission Power* IE is included for that CCTrCH, then the Node B shall use that power for the minimum DL power, otherwise the minimum DL power is the *Minimum DL Power* IE included in the *RL Information* IE.]

[3.84 Mcps TDD - The initial power, maximum power, and minimum power for DSCH type CCTrCH shall be determined as follows:

- If the DSCH type CCTrCH is paired with an uplink CCTrCH(s) for inner loop power control, the minimum, maximum and initial power for each PDSCH is determined in the same way as described above for DCH type CCTrCHs.
- If the DSCH type CCTrCH is not paired with an uplink CCTrCH(s) for inner loop power control, the PDSCH transmission power is DSCH Data Frame Protocol signalled [24], with the maximum value determined in the same way as described above for DCH type CCTrCHs. The minimum and initial powers, however, are subject to control by the CRNC via the frame protocol].

[1.28 Mcps TDD - The Node B shall determine the initial DL power for each timeslot within the DCH type CCTrCH by the following rule: If the *Initial DL Transmission Power* IE is included in the *DL Timeslot Information LCR* IE, then the Node B shall use that power for the Initial DL Power and ignore the *DL Time Slot ISCP info LCR* IE, otherwise the initial DL Power is the *Initial DL Transmission Power* IE included in the *RL Information* IE and if *DL Time Slot ISCP info LCR* IE is present, the Node B shall use the indicated value when deciding the initial DL TX Power for each timeslot as specified in [21], it shall reduce the DL TX power in those downlink timeslots of the radio link where the interference is low, and increase the DL TX power in those timeslots where the interference is high, while keeping the total downlink power in the radio link unchanged. The Node B shall start any DL transmission on each timeslot within each DCH type CCTrCH using the initial DL power, as determined above, on each DL DPCH and on each timeslot of the CCTrCH until the UL synchronisation on the Uu interface is achieved for the CCTrCH. No inner loop power control shall be performed during this period. The DL power shall then vary according to the inner loop power control (see ref.[21], subclause 5.1.2.4), but shall always be kept within the maximum and minimum limit specified in the RADIO LINK SETUP REQUEST message.]

[1.28 Mcps TDD - The Node B shall determine the maximum DL power for each timeslot within the DCH type CCTrCH by the following rule: If the *Maximum DL Power* IE is included in the *DL Timeslot Information LCR* IE, then the Node B shall use that power for the maximum DL power, otherwise the maximum DL power is the *Maximum DL Power* IE included in the *RL Information* IE.]

[1.28 Mcps TDD - The Node B shall determine the minimum DL power for each timeslot within the DCH type CCTrCH by the following rule: If the *Minimum DL Power* IE is included in the *DL Timeslot Information LCR* IE, then the Node B shall use that power for the minimum DL power, otherwise the minimum DL power is the *Minimum DL Power* IE included in the *RL Information* IE.]

[1.28 Mcps TDD - The Node B shall determine the initial power for each timeslot within the DSCH type CCTrCH by the following rule: If both the *CCTrCH Initial DL Transmission Power* IE, included in the *DL CCTrCH Information* IE, and the *DL Time Slot ISCP Info LCR* IE, included in the *RL Information* IE, are included then the Node B shall use that power for the PDSCH and ignore the *Initial DL Transmission Power*

IE included in the *RL Information* IE, otherwise the initial DL Power is the *Initial DL Transmission Power* IE included in the *RL Information* IE and if *DL Time Slot ISCP info LCR* IE is present, the Node B shall use the indicated value when deciding the initial DL TX Power for each timeslot as specified in [21], it shall reduce the DL TX power in those downlink timeslots of the radio link where the interference is low, and increase the DL TX power in those timeslots where the interference is high, while keeping the total downlink power in the radio link unchanged. The Node B shall start any DL transmission on each timeslot within each DSCH type CCTrCH using the initial DL power, as determined above, on each DL PDSCH and on each timeslot of the CCTrCH until the UL synchronisation on the Uu interface is achieved for the CCTrCH. No inner loop power control shall be performed during this period. The DL power shall then vary according to the inner loop power control (see ref.[21], subclause 5.1.2.4), but shall always be kept within the maximum and minimum limit specified in the RADIO LINK SETUP REQUEST message.]

[1.28 Mcps TDD - The Node B shall determine the maximum DL power for each timeslot within the DSCH type CCTrCH by the following rule: If the *CCTrCH Maximum DL Transmission Power* IE, included in the *DL CCTrCH Information* IE, is included then the Node B shall use that power for the maximum DL power, otherwise the maximum DL power is the *Maximum DL Power* IE included in the *RL Information* IE.]

[1.28 Mcps TDD - The Node B shall determine the minimum DL power for each timeslot within the DSCH type CCTrCH by the following rule: If the *CCTrCH Minimum DL Transmission Power* IE, included in the *DL CCTrCH Information* IE, is included then the Node B shall use that power for the minimum DL power, otherwise the minimum DL power is the *Minimum DL Power* IE included in the *RL Information* IE.]

[3.84Mcps TDD - If the *DL Time Slot ISCP Info* IE is present, the Node B shall use the indicated value when deciding the initial DL TX Power for each timeslot as specified in [21], i.e. it shall reduce the DL TX power in those downlink timeslots of the radio link where the interference is low, and increase the DL TX power in those timeslots where the interference is high, while keeping the total downlink power in the radio link unchanged].

[FDD - If the received *Inner Loop DL PC Status* IE is set to "Active", the Node B shall activate the inner loop DL power control for all RLS. If *Inner Loop DL PC Status* IE is set to "Inactive", the Node B shall deactivate the inner loop DL power control for all RLS according to ref. [10].]

[FDD - If the RADIO LINK SETUP REQUEST message includes the *DL Power Balancing Information* IE and the *Power Adjustment Type* IE is set to "Common" or "Individual", the Node B shall activate the power balancing, if activation of power balancing by the RADIO LINK SETUP REQUEST message is supported, according to subclause 8.3.7, using the *DL Power Balancing Information* IE. If the Node B starts the DL transmission and the activation of the power balancing at the same CFN, the initial power of the power balancing, i.e.  $P_{init}$  shall be set to the power level indicated by the *Initial DL Transmission Power* IE.]

[FDD - If activation of power balancing by the RADIO LINK SETUP REQUEST message is supported by the Node B, the Node B shall include the *DL Power Balancing Activation Indicator* IE in the *RL Information Response* IE in the RADIO LINK SETUP RESPONSE message.]

#### **[1.28Mcps TDD - Uplink Synchronisation Parameters LCR]:**

[1.28Mcps TDD - If the RADIO LINK SETUP REQUEST message contains the *Uplink Synchronisation Parameters LCR* IE, the Node B shall use the indicated values of *Uplink Synchronisation Step Size* IE and *Uplink Synchronisation Frequency* IE when evaluating the timing of the UL synchronisation.]

#### **General:**

If the RADIO LINK SETUP REQUEST message includes the *RL Specific DCH Information* IE, the Node B may use the transport layer address and the binding identifier received from the CRNC when establishing a transport bearer for the DCH or the set of co-ordinated DCHs.

[FDD - If the RADIO LINK SETUP REQUEST message includes the *SSDT Cell Identity* IE and the *S-Field Length* IE, the Node B shall activate SSDT, if supported, using the *SSDT Cell Identity* IE and *SSDT Cell Identity Length* IE.]

[FDD - If the RADIO LINK SETUP REQUEST message includes the *Qth Parameter* IE in addition to the *SSDT Cell Identity* IE, the Node B shall use the *Qth Parameter* IE, if Qth signalling is supported, when SSDT is activated.]

[FDD - Irrespective of SSdT activation, the Node B shall include in the RADIO LINK SETUP RESPONSE message an indication concerning the capability to support SSdT on this RL. Only if the RADIO LINK SETUP REQUEST message requested SSdT activation and the RADIO LINK SETUP RESPONSE message indicates that the SSdT capability is supported for this RL, SSdT is activated in the Node B.]

[FDD - If the RADIO LINK SETUP REQUEST message includes the *SSdT Cell Identity for EDSCHPC* IE, the Node B shall activate enhanced DSCH power control, if supported, using the *SSdT Cell Identity For EDSCHPC* IE and *SSdT Cell Identity Length* IE as well as *Enhanced DSCH PC* IE in accordance with ref. [10] subclause 5.2.2. If the RADIO LINK SETUP REQUEST message includes both *SSdT Cell Identity* IE and *SSdT Cell Identity For EDSCHPC* IE, then the Node B shall ignore the value in *SSdT Cell Identity For EDSCHPC* IE. If the enhanced DSCH power control is activated and the TFCI power control in DSCH hard split mode is supported, the primary/secondary status determination in the enhanced DSCH power control is also applied to the TFCI power control in DSCH hard split mode.]

The Node B shall start reception on the new RL(s) after the RLs are successfully established.

#### [FDD - Radio Link Set Handling]:

[FDD - The *First RLS Indicator* IE indicates if the concerned RL shall be considered part of the first RLS established towards this UE. The *First RLS Indicator* IE shall be used by the Node B together with the value of the *DL TPC Pattern 01 Count* IE which the Node B has received in the Cell Setup procedure, to determine the initial TPC pattern in the DL of the concerned RL and all RLs which are part of the same RLS, as described in [10], section 5.1.2.2.1.2.]

[FDD - For each RL not having a common generation of the TPC commands in the DL with another RL, the Node B shall assign the *RL Set ID* IE included in the RADIO LINK SETUP RESPONSE message a value that uniquely identifies the RL Set within the Node B Communication Context.]

[FDD - For all RLs having a common generation of the TPC commands in the DL with another RL, the Node B shall assign the *RL Set ID* IE included in the RADIO LINK SETUP RESPONSE message the same value. This value shall uniquely identify the RL Set within the Node B Communication Context.]

[FDD - The UL out-of-sync algorithm defined in [10] shall, for each of the established RL Set(s), use the maximum value of the parameters *N\_OUTSYNC\_IND* and *T\_RLFAILURE* that are configured in the cells supporting the radio links of the RL Set. The UL in-sync algorithm defined in [10] shall, for each of the established RL Set(s), use the minimum value of the parameters *N\_INSYNC\_IND*, that are configured in the cells supporting the radio links of the RL Set.]

#### Response Message:

If the RLs are successfully established, the Node B shall and respond with a RADIO LINK SETUP RESPONSE message.

After sending the RADIO LINK SETUP RESPONSE message the Node B shall continuously attempt to obtain UL synchronisation on the Uu interface.

For each RL for which the *Delayed Activation* IE is not included in the RADIO LINK SETUP REQUEST message, the Node B shall:

- [FDD - start transmission on the DL DPDCH(s) of the new RL as specified in [16].]
- [TDD - start transmission on the new RL immediately as specified in [16].]

For each RL for which the *Delayed Activation* IE is included in the RADIO LINK SETUP REQUEST message, the Node B shall:

- if the *Delayed Activation* IE indicates "Separate Indication":
  - not start any DL transmission for the concerned RL on the Uu interface;
- if the *Delayed Activation* IE indicates "CFN":
  - [FDD - start transmission on the DL DPDCH(s) of the new RL as specified in [16], however never before the CFN indicated in the *Activation CFN* IE.]
  - [TDD - start transmission on the new RL at the CFN indicated in the *Activation CFN* IE as specified in [16].]

### 8.2.17.3 Unsuccessful Operation

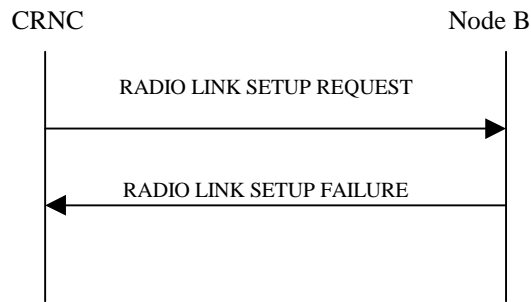

**Figure 25: Radio Link Setup procedure, Unsuccessful Operation**

If the establishment of at least one radio link is unsuccessful, the Node B shall respond with a RADIO LINK SETUP FAILURE message. The message contains the failure cause in the *Cause* IE.

[FDD - If some radio links were established successfully, the Node B shall indicate this in the RADIO LINK SETUP FAILURE message in the same way as in the RADIO LINK SETUP RESPONSE message. In this case, the Node B shall include the *Communication Control Port Id* IE in the RADIO LINK SETUP FAILURE message.]

[FDD - If the RL identified by the *HS-PDSCH RL ID* IE is a radio link in the Node B and this RL is successfully established, then the Node B shall include the *HS-DSCH FDD Information Response* IE in the RADIO LINK SETUP FAILURE message.]

Typical cause values are as follows:

**Radio Network Layer Cause:**

- Combining not supported
- Combining Resources not available
- Requested Tx Diversity Mode not supported
- Number of DL codes not supported
- Number of UL codes not supported
- UL SF not supported
- DL SF not supported
- Dedicated Transport Channel Type not supported
- Downlink Shared Channel Type not supported
- Uplink Shared Channel Type not supported
- CM not supported
- DPC mode change not supported
- Delayed Activation not supported
- HARQ Preamble Mode not supported

[- F-DPCH not supported.](#)

**Transport Layer Cause:**

- Transport Resources Unavailable

**Miscellaneous Cause:**

- O&M Intervention
- Control processing overload
- HW failure

### 8.2.17.4 Abnormal Conditions

[FDD - If the RADIO LINK SETUP REQUEST message contains the *Active Pattern Sequence Information* IE, but the *Transmission Gap Pattern Sequence Information* IE is not present, then the Node B shall reject the procedure using the RADIO LINK SETUP FAILURE message.]

If more than one DCH of a set of co-ordinated DCHs has the *QE-Selector* IE set to "selected" [TDD – or no DCH of a set of co-ordinated DCHs has the *QE-Selector* IE set to "selected"], the Node B shall regard the Radio Link Setup procedure as failed and shall respond with a RADIO LINK SETUP FAILURE message.

If the RADIO LINK SETUP REQUEST message includes a *DCH Information* IE with multiple *DCH Specific Info* IEs, and if the DCHs in the *DCH Information* IE do not have the same *Transmission Time Interval* IE in the *Semi-static Transport Format Information* IE, then the Node B shall reject the procedure using the RADIO LINK SETUP FAILURE message.

If the RADIO LINK SETUP REQUEST message includes the *Transport Layer Address* IE and the *Binding ID* IE in the *RL Specific DCH Information* IE included in the *RL Information* IE for a specific RL and the *Diversity Control Field* IE is set to "Must", the Node B shall regard the Radio Link Setup procedure as failed and respond with the RADIO LINK SETUP FAILURE message.

If the RADIO LINK SETUP REQUEST message contains the *Transport Layer Address* IE or the *Binding ID* IE, and not both are present for a transport bearer intended to be established, the Node B shall reject the procedure using the RADIO LINK SETUP FAILURE message.

[FDD - If the RADIO LINK SETUP REQUEST message includes the *Length Of TFCI2* IE but the *TFCI Signalling Option* IE is set to "Normal", then the Node B shall reject the procedure using the RADIO LINK SETUP FAILURE message.]

[FDD - If the RADIO LINK SETUP REQUEST message does not include the *Length Of TFCI2* IE but the *Split Type* IE is set to "Logical", then the Node B shall reject the procedure using the RADIO LINK SETUP FAILURE message.]

[FDD - If the RADIO LINK SETUP REQUEST message includes the *Split Type* IE set to the value "Hard" and the *Length Of TFCI2* IE set to the value "1", "2", "5", "8", "9" or "10", then the Node B shall reject the procedure using the RADIO LINK SETUP FAILURE message.]

If the RADIO LINK SETUP REQUEST message includes an *HS-PDSCH RL-ID* IE not referring to one of the radio links to be established, the Node B shall reject the procedure using the RADIO LINK SETUP FAILURE message.

If the RADIO LINK SETUP REQUEST message contains the *HS-DSCH Information* IE and if the Priority Queues associated with the same *HS-DSCH MAC-d Flow ID* IE have the same *Scheduling Priority Indicator* IE value, the Node B shall reject the procedure using the RADIO LINK SETUP FAILURE message.

[FDD - If the RADIO LINK SETUP REQUEST message contains the *F-DPCH Information* IE and the *DL DPCH Information* IE, then the Node B shall reject the procedure using the RADIO LINK SETUP FAILURE message.]

[FDD - If the concerned Node B Communication Context is configured to use F-DPCH in the downlink, if at least one *Transmission Gap Pattern Sequence* is configured with an SF/2 downlink compressed mode method in the *Compressed Mode Configuration* and if the RADIO LINK SETUP REQUEST message includes the *Transmission Gap Pattern Sequence Code Information* IE for any DL Channelisation Code, then the Node B shall reject the procedure using the RADIO LINK SETUP FAILURE message.]



## 8.3.1 Radio Link Addition

### 8.3.1.1 General

This procedure is used for establishing the necessary resources in the Node B for one or more additional RLs towards a UE when there is already a Node B Communication Context for this UE in the Node B.

The Radio Link Addition procedure shall not be initiated if a Prepared Reconfiguration exists, as defined in subclause 3.1.

### 8.3.1.2 Successful Operation

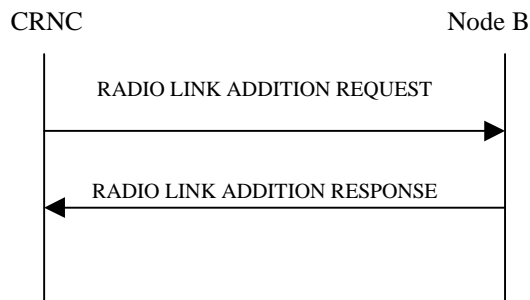

**Figure: 28 Radio Link Addition procedure, Successful Operation**

The procedure is initiated with a RADIO LINK ADDITION REQUEST message sent from the CRNC to the Node B using the Communication Control Port assigned to the concerned Node B Communication Context.

Upon reception, the Node B shall reserve the necessary resources and configure the new RL(s) according to the parameters given in the message. Unless specified below, the meaning of parameters is specified in other specifications.

The Node B shall prioritise resource allocation for the RL(s) to be established according to Annex A.

#### Physical Channels Handling:

[TDD – If the [3.84Mcps TDD - *UL DPCH Information IE*] [1.28Mcps TDD - *UL DPCH Information LCR IE*] is present, the Node B shall configure the new UL DPCH(s) according to the parameters given in the message.]

[TDD – If the [3.84Mcps TDD - *DL DPCH Information IE*] [1.28Mcps TDD - *DL DPCH Information LCR IE*] is present, the Node B shall configure the new DL DPCH(s) according to the parameters given in the message.]

#### [FDD – Compressed Mode]:

[FDD – If the RADIO LINK ADDITION REQUEST message includes the *Compressed Mode Deactivation Flag IE* with value "Deactivate", the Node B shall not activate any compressed mode pattern in the new RLs. In all the other cases (Flag set to "Maintain Active" or not present), the ongoing compressed mode (if existing) shall be applied also to the added RLs.]

[FDD- If [the Node B Communication Context is configured to use DPCH in the downlink and if](#) the RADIO LINK ADDITION REQUEST message contains the *Transmission Gap Pattern Sequence Code Information IE* for any of the allocated DL Channelisation Codes, the Node B shall apply the alternate scrambling code as indicated for each DL Channelisation Code for which the *Transmission Gap Pattern Sequence Code Information IE* is set to "Code Change".]

#### [FDD – DL Code Information]:

[FDD – When more than one DL DPDCH are assigned per RL, the segmented physical channel shall be mapped on to DL DPDCHs according to ref. [8]. When  $p$  number of DL DPDCHs are assigned to each RL, the first pair of DL Scrambling Code and FDD DL Channelisation Code Number corresponds to "*PhCH number 1*", the second to "*PhCH number 2*", and so on until the  $p$ th to "*PhCH number p*".]

#### [TDD – CCTrCH Handling]:

[TDD – If the *UL CCTrCH Information* IE is present, the Node B shall configure the new UL CCTrCH(s) according to the parameters given in the message.]

[1.28Mcps TDD - If the *UL CCTrCH Information* IE includes the *TDD TPC UL Step Size* IE, the Node B shall configure the uplink TPC step size according to the parameters given in the message, otherwise it shall use the step size configured in other radio link.]

[TDD – If the *DL CCTrCH Information* IE is present, the Node B shall configure the new DL CCTrCH(s) according to the parameters given in the message.]

[TDD - If the *DL CCTrCH Information* IE includes the *TDD TPC DL Step Size* IE, the Node B shall configure the downlink TPC step size according to the parameters given in the message, otherwise it shall use the step size configured in other radio link.]

**[FDD – Phase Reference Handling]:**

[FDD – If the RADIO LINK ADDITION REQUEST message includes the *Primary CPICH Usage For Channel Estimation* IE and has the value "Primary CPICH shall not be used", the Node B shall assume that the UE is not using the Primary CPICH for channel estimation. If the RADIO LINK ADDITION REQUEST message does not include the *Primary CPICH Usage For Channel Estimation* IE or includes the *Primary CPICH Usage For Channel Estimation* IE and has the value "Primary CPICH may be used", the Node B shall assume that the UE may use the Primary CPICH for channel estimation.]

**Radio Link Handling:**

**Diversity Combination Control:**

The *Diversity Control Field* IE indicates for each RL whether the Node B shall combine the new RL with existing RL(s) or not.

- If the *Diversity Control Field* IE is set to "May", the Node B shall decide for any of the alternatives.
- If the *Diversity Control Field* IE is set to "Must", the Node B shall combine the RL with one of the other - RL.
- If the *Diversity Control Field* IE is set to "Must not", the Node B shall not combine the RL with any other existing RL.

[FDD - The *Diversity Control Field* IE is only applicable for DCHs, in case of E-DCH it shall always be assumed to be set to "Must".]

When a new RL is to be combined, the Node B shall choose which RL(s) to combine it with.

In the case of not combining a RL with a RL established with a previous Radio Link Setup or Radio Link Addition Procedure or a RL previously listed in the RADIO LINK ADDITION RESPONSE message, the Node B shall indicate with the Diversity Indication in the *RL Information Response* IE in the RADIO LINK ADDITION RESPONSE message that no combining is done. In this case, the Node B shall include in the *DCH Information Response* IE both the *Transport Layer Address* IE and the *Binding ID* IE for the transport bearer to be established for each DCH of the RL in the RADIO LINK ADDITION RESPONSE message.

In the case of combining with a RL established with a previous Radio Link Setup or Radio Link Addition Procedure or with a RL previously listed in this RADIO LINK ADDITION RESPONSE message, the Node B shall indicate with the Diversity Indication in the *RL Information Response* IE in the RADIO LINK ADDITION RESPONSE message that the RL is combined. In this case, the *RL ID* IE indicates (one of) the previously established RL(s) or a RL previously listed in this RADIO LINK ADDITION RESPONSE message with which the new RL is combined.

In the case of a set of co-ordinated DCHs, the *Binding ID* IE and the *Transport Layer Address* IE shall be included for only one of the DCHs in a set of coordinated DCHs.

[TDD – The Node B shall include in the RADIO LINK ADDITION RESPONSE message both the *Transport Layer Address* IE and the *Binding ID* IE for the transport bearer to be established for each DSCH and USCH.]

**[FDD – Transmit Diversity]:**

[FDD – If the *Transmit Diversity Indicator* IE is included in the RADIO LINK ADDITION REQUEST message, the Node B shall activate/deactivate the Transmit Diversity for each new Radio Link in accordance with the *Transmit Diversity Indicator* IE and the already known diversity mode.]

#### **DL Power Control:**

[FDD – If the RADIO LINK ADDITION REQUEST message includes the *Initial DL Transmission Power* IE, the Node B shall apply the given power to the transmission on each DL DPCH [or on the F-DPCH](#) of the RL when starting transmission until either UL synchronisation on the Uu interface is achieved for the RLS or Power Balancing is activated. If no *Initial DL Transmission Power* IE is included, the Node B shall use any transmission power level currently used on already existing RLs for this Node B Communication Context. No inner loop power control or balancing shall be performed during this period. The DL power shall then vary according to the inner loop power control (see ref.[10], subclause 5.2.1.2) with DPC MODE currently configured for the relevant Node B Communication Context and the downlink power control procedure (see subclause 8.3.7).]

[3.84 Mcps TDD – If the RADIO LINK ADDITION REQUEST message includes the *Initial DL Transmission Power* IE, the Node B shall determine the initial CCTrCH DL power for each DCH type CCTrCH by the following rule: If the *CCTrCH Initial DL Transmission Power* IE is included for that CCTrCH, then the Node B shall use that power for the initial CCTrCH DL power, otherwise the initial CCTrCH DL power is the *Initial DL Transmission Power* IE included in the *RL Information* IE. The Node B shall apply the given power to the transmission on each DL DPCH and on each Time Slot of the CCTrCH when starting transmission until the UL synchronisation on the Uu interface is achieved for the CCTrCH. If no *Initial DL Transmission Power* IE is included (even if *CCTrCH Initial DL Transmission Power* IEs are included), the Node B shall use any transmission power level currently used on already existing CCTrCHs for this Node B Communication Context. No inner loop power control shall be performed during this period. The DL power shall then vary according to the inner loop power control (see ref.[21], subclause 4.2.3.4).]

[1.28 Mcps TDD - If the RADIO LINK ADDITION REQUEST message includes the *Initial DL Transmission Power* IE, the Node B shall determine the initial DL power for each timeslot within a DCH type CCTrCH by the following rule: If the *Initial DL Transmission Power* IE is included in the *DL Timeslot Information LCR* IE, then the Node B shall use that power for the initial DL power and ignore the *DL Time Slot ISCP info LCR*, otherwise the initial DL power is the *Initial DL Transmission Power* IE included in the *RL Information* IE and if *DL Time Slot ISCP info LCR* IE is present, the Node B shall use the indicated value when deciding the initial DL TX Power for each timeslot as specified in [21], it shall reduce the DL TX power in those downlink timeslots of the radio link where the interference is low, and increase the DL TX power in those timeslots where the interference is high, while keeping the total downlink power in the radio link unchanged. The Node B shall apply the given power to the transmission on each DL DPCH and on each Time Slot of the CCTrCH when starting transmission until the UL synchronisation on the Uu interface is achieved for the CCTrCH. If no *Initial DL Transmission Power* IE is included, the Node B shall use any transmission power level currently used on already existing RL/timeslots for this Node B Communication Context. No inner loop power control shall be performed during this period. The DL power shall then vary according to the inner loop power control (see ref.[21], subclause 5.1.2.4).]

[FDD - If the RADIO LINK ADDITION REQUEST message includes the *Maximum DL Power* IE, the Node B shall store this value and not transmit with a higher power on any DL DPCH [or on the F-DPCH](#) of the RL. If no *Maximum DL Power* IE is included, any Maximum DL power stored for already existing RLs for this Node B Communication Context shall be applied. [If the Node B Communication Context is configured to use DPCH in the downlink](#), during compressed mode, the  $\delta P_{curr}$ , as described in ref.[10] subclause 5.2.1.3, shall be added to the maximum DL power for the associated compressed frame.]

[FDD - If the RADIO LINK ADDITION REQUEST message includes the *Minimum DL Power* IE, the Node B shall store this value and never transmit with a lower power on any DL DPCH [or on the F-DPCH](#) of the RL. If no *Minimum DL Power* IE is included, any Minimum DL power stored for already existing RLs for this Node B Communication Context shall be applied.]

[3.84 Mcps TDD - If the RADIO LINK ADDITION REQUEST message includes the *Maximum DL Power* IE, the Node B shall determine the maximum CCTrCH DL power for each DCH type CCTrCH by the following rule: If the *CCTrCH Maximum DL Transmission Power* IE is included for that CCTrCH, then the Node B shall use that power for the maximum CCTrCH DL power, otherwise the maximum CCTrCH DL power is the *Maximum DL Power* IE included in the *RL Information* IE. If no *Maximum DL Power* IE is included (even if *CCTrCH Maximum DL Transmission Power* IEs are included), any maximum DL power stored for already existing DCH type CCTrCHs for this Node B Communication Context shall be applied.]

[3.84 Mcps TDD - If the RADIO LINK ADDITION REQUEST message includes the *Minimum DL Power IE*, the Node B shall determine the minimum CCTrCH DL power for each DCH type CCTrCH by the following rule: If the *CCTrCH Minimum DL Transmission Power IE* is included for that CCTrCH, then the Node B shall use that power for the minimum CCTrCH DL power, otherwise the minimum CCTrCH DL power is the *Minimum DL Power IE* included in the *RL Information IE*. If no *Minimum DL Power IE* is included (even if *CCTrCH Minimum DL Transmission Power IEs* are included), any minimum DL power stored for already existing DCH type CCTrCHs for this Node B Communication Context shall be applied.]

[1.28 Mcps TDD - If the RADIO LINK ADDITION REQUEST message includes the *Maximum DL Power IE*, the Node B shall determine the maximum DL power for each timeslot within a DCH type CCTrCH by the following rule: If the *Maximum DL Power IE* is included in the *DL Timeslot Information LCR IE* for that timeslot, then the Node B shall use that power for the maximum DL power, otherwise the maximum DL power is the *Maximum DL Power IE* included in the *RL Information IE*. The Node B shall store this value and not transmit with a higher power on any applicable DL DPCH. If no *Maximum DL Power IE* is included, any maximum DL power stored for already existing RL/timeslots for this Node B Communication Context shall be applied.]

[1.28 Mcps TDD - If the RADIO LINK ADDITION REQUEST message includes the *Minimum DL Power IE*, the Node B shall determine the minimum DL power for each timeslot within a DCH type CCTrCH by the following rule: If the *Minimum DL Power IE* is included in the *DL Timeslot Information LCR IE* for that timeslot, then the Node B shall use that power for the minimum DL power, otherwise the minimum DL power is the *Minimum DL Power IE* included in the *RL Information IE*. The Node B shall store this value and not transmit with a lower power on any applicable DL DPCH. If no *Minimum DL Power IE* is included, any minimum DL power stored for already existing RL/timeslots for this Node B Communication Context shall be applied.]

[3.84Mcps TDD - The initial power, maximum power, and minimum power for DSCH type CCTrCH shall be determined as follows:

- If the DSCH type CCTrCH is paired with an uplink CCTrCH(s) for inner loop power control, the minimum, maximum and initial power for each PDSCH is determined in the same way as described above for DCH type CCTrCHs.
- If the DSCH type CCTrCH is not paired with an uplink CCTrCH(s) for inner loop power control, the PDSCH transmission power is DSCH Data Frame Protocol signalled [24], with the maximum value determined in the same way as described above for DCH type CCTrCHs. The minimum and initial powers, however, are subject to control by the CRNC via the frame protocol].

[1.28 Mcps TDD – If the RADIO LINK ADDITION REQUEST message includes the *Initial DL Transmission Power IE*, the Node B shall determine the initial DL power for each timeslot within a DSCH type CCTrCH by the following rule: If both the *CCTrCH Initial DL Transmission Power IE*, included in the *DL CCTrCH Information IE*, and the *DL Time Slot ISCP Info LCR IE*, included in the *RL Information IE*, are included then the Node B shall use that power for the PDSCH and ignore the *Initial DL Transmission Power IE* included in the *RL Information IE*, otherwise the initial DL Power is the *Initial DL Transmission Power IE* included in the *RL Information IE* and if *DL Time Slot ISCP info LCR IE* is present, the Node B shall use the indicated value when deciding the initial DL TX Power for each timeslot as specified in [21], it shall reduce the DL TX power in those downlink timeslots of the radio link where the interference is low, and increase the DL TX power in those timeslots where the interference is high, while keeping the total downlink power in the radio link unchanged. The Node B shall apply the given power to the transmission on each DL PDSCH and on each Time Slot of the CCTrCH when starting transmission until the UL synchronisation on the Uu interface is achieved for the CCTrCH. If no *Initial DL Transmission Power IE* is included, the Node B shall use any transmission power level currently used on already existing RL/timeslots for this Node B Communication Context. No inner loop power control shall be performed during this period. The DL power shall then vary according to the inner loop power control (see ref.[21], subclause 5.1.2.4).]

[1.28 Mcps TDD - If the RADIO LINK ADDITION REQUEST message includes the *Maximum DL Power IE*, the Node B shall determine the maximum DL power for each timeslot within a DSCH type CCTrCH by the following rule: If the *CCTrCH Maximum DL Transmission Power IE*, included in the *DL CCTrCH Information IE*, is included then the Node B shall use that power for the maximum DL power, otherwise the maximum DL power is the *Maximum DL Power IE* included in the *RL Information IE*. The Node B shall store this value and not transmit with a higher power on any applicable PDSCH. If no *Maximum DL Power IE* is included, any maximum DL power stored for already existing RL/timeslots for this Node B Communication Context shall be applied.]

[1.28 Mcps TDD - If the RADIO LINK ADDITION REQUEST message includes the *Minimum DL Power* IE, the Node B shall determine the minimum DL power for each timeslot within a DSCH type CCTrCH by the following rule: If the *CCTrCH Minimum DL Transmission Power* IE, included in the *DL CCTrCH Information* IE, is included then the Node B shall use that power for the minimum DL power, otherwise the minimum DL power is the *Minimum DL Power* IE included in the *RL Information* IE. The Node B shall store this value and not transmit with a lower power on any applicable PDSCH. If no *Minimum DL Power* IE is included, any minimum DL power stored for already existing RL/timeslots for this Node B Communication Context shall be applied.]

[3.84 Mcps TDD – If the RADIO LINK ADDITION REQUEST message includes the *DL Time Slot ISCP Info* IE, the Node B shall use the indicated value when deciding the DL TX Power for each timeslot as specified in ref. [21], i.e. it shall reduce the DL TX power in those downlink timeslots of the radio link where the interference is low, and increase the DL TX power in those timeslots where the interference is high, while keeping the total downlink power in the radio link unchanged].

[FDD – If the power balancing is active with the Power Balancing Adjustment Type of the Node B Communication Context set to "Individual" in the existing RL(s) and the RADIO LINK ADDITION REQUEST message includes the *DL Reference Power* IE, the Node B shall activate the power balancing and use the *DL Reference Power* IE for the power balancing procedure in the new RL(s), if activation of power balancing by the RADIO LINK ADDITION REQUEST message is supported, according to subclause 8.3.7. In this case, the Node B shall include the *DL Power Balancing Activation Indicator* IE in the *RL Information Response* IE in the RADIO LINK ADDITION RESPONSE message. If the Node B starts the DL transmission and the activation of the power balancing at the same CFN, the initial power of the power balancing, i.e.  $P_{init}$  shall be set to the power level indicated by the *Initial DL Transmission Power* IE (if received) or the decided DL TX power level on each DL channelisation code of a RL based on power level of existing RLs.]

**[1.28 Mcps TDD – Uplink Synchronisation Parameters LCR]:**

[1.28 Mcps TDD - If the RADIO LINK ADDITION REQUEST message contains the *Uplink Synchronisation Parameters LCR* IE, the Node B shall use the indicated values of *Uplink Synchronisation Stepsize* IE and *Uplink Synchronisation Frequency* IE when evaluating the timing of the UL synchronisation.]

**General:**

If the RADIO LINK ADDITION REQUEST message includes the *RL Specific DCH Information* IE, the Node B may use the transport layer address and the binding identifier received from the CRNC when establishing a transport bearer for the DCH or the set of co-ordinated DCHs.

[FDD – If the RADIO LINK ADDITION REQUEST message contains an *SSDT Cell Identity* IE, the Node B shall activate SSDT, if supported, for the concerned new RL, with the indicated SSDT cell identity used for that RL.]

[FDD – If the RADIO LINK ADDITION REQUEST message includes the *Qth Parameter* IE in addition to the *SSDT Cell Identity* IE, the Node B shall use the *Qth Parameter* IE, if Qth signalling is supported, when SSDT is activated in the concerned new RL.]

The Node B shall start reception on the new RL(s) after the RLs are successfully established.

**[FDD – Radio Link Set Handling]:**

[FDD – For each RL not having a common generation of the TPC commands in the DL with another RL, the Node B shall assign the *RL Set ID* IE included in the RADIO LINK ADDITION RESPONSE message a value that uniquely identifies the RL Set within the Node B Communication Context.]

[FDD – For all RLs having a common generation of the TPC commands in the DL with another new or existing RL, the Node B shall assign the *RL Set ID* IE included in the RADIO LINK ADDITION RESPONSE message the same value. This value shall uniquely identify the RL Set within the Node B Communication Context.]

[FDD – After addition of the new RL(s), the UL out-of-sync algorithm defined in [10] shall, for each of the previously existing and newly established RL Set(s), use the maximum value of the parameters N\_OUTSYNC\_IND and T\_RLFAILURE that are configured in the cells supporting the radio links of the RL Set. The UL in-sync algorithm

defined in [10] shall, for each of the established RL Set(s), use the minimum value of the parameters N\_INSYNC\_IND, that are configured in the cells supporting the radio links of the RL Set.]

**[FDD - E-DCH]:**

[FDD – If the RADIO LINK ADDITION REQUEST message contains the *E-DCH RL Indication* IE in the *RL Information* IE, then for every such RL:]

- [FDD – The Node B shall setup the E-DCH resources as configured in the Node B Communication Context.]
- [FDD – The Node B shall include the E-AGCH And E-RGCH/E-HICH FDD Scrambling Code IE, the E-RGCH/E-HICH Channelisation Code IE and the corresponding SequenceNumber IEs in the E-DCH FDD DL Control Channel Information IE in the RADIO LINK ADDITION RESPONSE message.]

**Response Message:**

If all requested RLs are successfully added, the Node B shall respond with a RADIO LINK ADDITION RESPONSE message.

After sending the RADIO LINK ADDITION RESPONSE message, the Node B shall continuously attempt to obtain UL synchronisation on the Uu interface.

For each RL for which the *Delayed Activation* IE is not included in the RADIO LINK ADDITION REQUEST message, the Node B shall:

- [FDD - start transmission on the DL DPDCH(s) of the new RL as specified in [16].]
- [TDD - start transmission on the new RL immediately as specified in [16].]

For each RL for which the *Delayed Activation* IE is included in the RADIO LINK ADDITION REQUEST message, the Node B shall:

- if the *Delayed Activation* IE indicates "Separate Indication":
  - not start any DL transmission for the concerned RL on the Uu interface;
- if the *Delayed Activation* IE indicates "CFN":
  - [FDD – start transmission on the DL DPDCH(s) of the new RL as specified in [16], however never before the CFN indicated in the *Activation CFN* IE.]
  - [TDD – start transmission on the new RL at the CFN indicated in the *Activation CFN* IE as specified in [16].]

### 8.3.1.3 Unsuccessful Operation

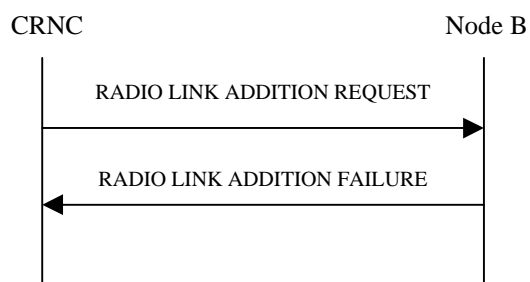

**Figure 29: Radio Link Addition procedure: Unsuccessful Operation**

If the establishment of at least one radio link is unsuccessful, the Node B shall respond with a RADIO LINK ADDITION FAILURE message. The message contains the failure cause in the *Cause* IE.

[FDD - If some RL(s) were established successfully, the Node B shall indicate this in the RADIO LINK ADDITION FAILURE message in the same way as in the RADIO LINK ADDITION RESPONSE message.]

[FDD – If the RADIO LINK ADDITION REQUEST contains a *C-ID* IE indicating that a Radio Link must be established on a Cell where DPC Mode change is not supported and DPC Mode can be changed for the relevant Node B

Communication Context, the Node B shall consider the procedure as failed for the concerned Radio Link and shall respond with a RADIO LINK ADDITION FAILURE with the appropriate cause value ("DPC Mode change not supported").]

Typical cause values are as follows:

#### Radio Network Layer Cause

- Combining not supported
- Combining Resources not available
- Requested Tx Diversity Mode not supported
- UL SF not supported
- DL SF not supported
- Reconfiguration CFN not elapsed
- CM not supported
- [FDD – DPC Mode change not supported]
- Delayed Activation not supported

#### Transport Layer Cause

- Transport Resources Unavailable

#### Miscellaneous Cause

- O&M Intervention
- Control processing overload
- HW failure

### 8.3.1.4 Abnormal conditions

[FDD – If the RADIO LINK ADDITION REQUEST message contains the *Compressed Mode Deactivation Flag* IE with the value "Deactivate" when compressed mode is active for the existing RL(s), and at least one of the new RL is added in a cell that has the same UARFCN (both UL and DL) of at least one cell with an already existing RL, the Node B shall regard the Radio Link Addition procedure as failed and shall respond with a RADIO LINK ADDITION FAILURE message with the cause value "Invalid CM settings".]

[FDD – If the power balancing is active with the Power Balancing Adjustment Type of the Node B Communication Context set to "Individual" in the existing RL(s) and if the *DL Reference Power* IEs are included in the *RL Information* IE but the *DL Reference Power* IE is not present for each RL in the *RL Information* IE, the Node B shall regard the Radio Link Addition procedure as failed and shall respond with a RADIO LINK ADDITION FAILURE message.]

[FDD – If the RADIO LINK ADDITION REQUEST message includes the *DL Reference Power* IEs in the *RL Information* IE but the power balancing is not active in the existing RL(s) or the power balancing is active with the Power Balancing Adjustment Type of the Node B Communication Context set to "Common" in the existing RL(s), the Node B shall regard the Radio Link Addition procedure as failed and shall respond with a RADIO LINK ADDITION FAILURE message with the cause value "Power Balancing status not compatible".]

If the RADIO LINK ADDITION REQUEST message includes the *Transport Layer Address* IE and the *Binding ID* IE in the *RL Specific DCH Information* IE included in the *RL Information* IE for a specific RL and the *Diversity Control Field* IE is set to "Must", the Node B shall regard the Radio Link Addition procedure as failed and respond with the RADIO LINK ADDITION FAILURE message.

If the RADIO LINK ADDITION REQUEST message contains the *Transport Layer Address* IE or the *Binding ID* IE, and not both are present for a transport bearer intended to be established, the Node B shall reject the procedure using the RADIO LINK ADDITION FAILURE message.

[FDD - If the concerned Node B Communication Context is configured to use F-DPCH in the downlink, if at least one Transmission Gap Pattern Sequence is configured with an SF/2 downlink compressed mode method in the Compressed Mode Configuration and if the RADIO LINK ADDITION REQUEST message includes the *Transmission Gap Pattern Sequence Code Information IE* for any DL Channelisation Code, then the Node B shall reject the procedure using the RADIO LINK ADDITION FAILURE message.]



## 8.3.2 Synchronised Radio Link Reconfiguration Preparation

### 8.3.2.1 General

The Synchronised Radio Link Reconfiguration Preparation procedure is used to prepare a new configuration of Radio Link(s) related to one Node B Communication Context.

The Synchronised Radio Link Reconfiguration Preparation procedure shall not be initiated if a Prepared Reconfiguration exists, as defined in subclause 3.1.

### 8.3.2.2 Successful Operation

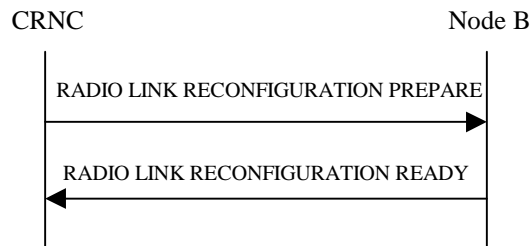

**Figure 30: Synchronised Radio Link Reconfiguration Preparation procedure, Successful Operation**

The Synchronised Radio Link Reconfiguration Preparation procedure is initiated by the CRNC by sending the RADIO LINK RECONFIGURATION PREPARE message to the Node B. The message shall use the Communication Control Port assigned for this Node B Communication Context.

Upon reception, the Node B shall reserve necessary resources for the new configuration of the Radio Link(s) according to the parameters given in the message. Unless specified below, the meaning of parameters is specified in other specifications.

The Node B shall prioritise resource allocation for the RL(s) to be modified according to Annex A.

#### **DCH Modification:**

If the RADIO LINK RECONFIGURATION PREPARE message includes any *DCHs To Modify* IE then the Node B shall treat them each as follows:

- If the *DCHs To Modify* IE includes the *Frame Handling Priority* IE, the Node B should store this information for this DCH in the new configuration. The received Frame Handling Priority should be used when prioritising between different frames in the downlink on the radio interface in congestion situations within the Node B once the new configuration has been activated.
- If the *DCHs To Modify* IE includes the *Transport Format Set* IE for the UL of a DCH, the Node B shall apply the new Transport Format Set in the Uplink of this DCH in the new configuration.
- If the *DCHs To Modify* IE includes the *TNL QoS* IE for a DCH or a set of co-ordinated DCHs to be modified and if ALCAP is not used, the Node B may store this information for this DCH in the new configuration. The *TNL QoS* IE may be used to determine the transport bearer characteristics to apply in the uplink for the related DCH or set of co-ordinated DCHs.
- If the *DCHs To Modify* IE includes the *Transport Format Set* IE for the DL of a DCH, the Node B shall apply the new Transport Format Set in the Downlink of this DCH in the new configuration.
- If the *DCHs To Modify* IE includes the *Allocation/Retention Priority* IE for a DCH, the Node B shall apply the new Allocation/Retention Priority to this DCH in the new configuration according to Annex A.
- If the *DCHs To Modify* IE includes multiple *DCH Specific Info* IEs, the Node B shall treat the DCHs in the *DCHs to Modify* IE as a set of co-ordinated DCHs. The Node B shall include these DCHs in the new configuration only if it can include all of them in the new configuration.

- If the *DCHs To Modify* IE includes the *UL FP Mode* IE for a DCH or a DCH which belongs to a set of co-ordinated DCHs, the Node B shall apply the new FP Mode in the Uplink of the user plane for the DCH or the set of co-ordinated DCHs in the new configuration.
- If the *DCHs To Modify* IE includes the *ToAWS* IE for a DCH or a DCH which belongs to a set of co-ordinated DCHs, the Node B shall apply the new ToAWS in the user plane for the DCH or the set of co-ordinated DCHs in the new configuration.
- If the *DCHs To Modify* IE includes the *ToAWE* IE for a DCH or a DCH which belongs to a set of co-ordinated DCHs, the Node B shall apply the new ToAWE in the user plane for the DCH or the set of co-ordinated DCHs in the new configuration.
- [TDD – If the *DCHs To Modify* IE includes the *CCTrCH ID* IE for the DL of a DCH to be modified, the Node B shall apply the new CCTrCH ID in the Downlink of this DCH in the new configuration.]
- [TDD – If the *DCHs To Modify* IE includes the *CCTrCH ID* IE for the UL of a DCH to be modified, the Node B shall apply the new CCTrCH ID in the Uplink of this DCH in the new configuration.]

#### DCH Addition:

If the RADIO LINK RECONFIGURATION PREPARE message includes any *DCHs To Add* IEs then the Node B shall treat them each as follows:

- If the *DCHs To Add* IE includes multiple *DCH Specific Info* IEs, the Node B shall treat the DCHs in the *DCHs To Add* IE as a set of co-ordinated DCHs. The Node B shall include these DCHs in the new configuration only if it can include all of them in the new configuration.
- If the *DCH Specific Info* IE includes the *Unidirectional DCH Indicator* IE set to "Uplink DCH only", the Node B shall ignore the *Transport Format Set* IE for the downlink for this DCH. As a consequence this DCH is not included as a part of the downlink CCTrCH.
- [TDD – If the *DCH Specific Info* IE includes the *Unidirectional DCH Indicator* IE set to "Downlink DCH only", the Node B shall ignore the *Transport Format Set* IE for the uplink for this DCH. As a consequence this DCH is not included as a part of the uplink CCTrCH.]
- [FDD – For DCHs which do not belong to a set of co-ordinated DCHs with the *QE-Selector* IE set to "selected", the Transport channel BER from that DCH shall be the base for the QE in the UL data frames. If no Transport channel BER is available for the selected DCH, the Physical channel BER shall be used for the QE, ref. [16]. If the *QE-Selector* IE is set to "non-selected", the Physical channel BER shall be used for the QE in the UL data frames, ref. [16].]
- For a set of co-ordinated DCHs, the Transport channel BER from the DCH with the *QE-Selector* IE set to "selected" shall be used for the QE in the UL data frames, ref. [16]. [FDD – If no Transport channel BER is available for the selected DCH, the Physical channel BER shall be used for the QE, ref. [16]. If all DCHs have the *QE-Selector* IE set to "non-selected", the Physical channel BER shall be used for the QE, ref. [16].]
- The Node B should store the *Frame Handling Priority* IE received for a DCH to be added in the new configuration. The received Frame Handling Priority should be used when prioritising between different frames in the downlink on the Uu interface in congestion situations within the Node B once the new configuration has been activated.
- If the *TNL QoS* IE is included for a DCH or a set of co-ordinated DCHs and if ALCAP is not used, the Node B may store this information for this DCH in the new configuration. The *TNL QoS* IE may be used to determine the transport bearer characteristics to apply for the uplink between the Node B and the CRNC for the related DCH or set of co-ordinated DCHs.
- The Node B shall use the included *UL FP Mode* IE for a DCH or a set of co-ordinated DCHs to be added as the new FP Mode in the Uplink of the user plane for the DCH or the set of co-ordinated DCHs in the new configuration.
- The Node B shall use the included *ToAWS* IE for a DCH or a set of co-ordinated DCHs to be added as the new Time of Arrival Window Startpoint in the user plane for the DCH or the set of co-ordinated DCHs in the new configuration.

- The Node B shall use the included *ToAWE* IE for a DCH or a set of co-ordinated DCHs to be added as the new Time of Arrival Window Endpoint in the user plane for the DCH or the set of co-ordinated DCHs in the new configuration.
- [TDD – The Node B shall apply the *CCTrCH ID* IE (for the DL) in the Downlink of this DCH in the new configuration.]
- [TDD – The Node B shall apply the *CCTrCH ID* IE (for the UL) in the Uplink of this DCH in the new configuration.]

#### **DCH Deletion:**

If the RADIO LINK RECONFIGURATION PREPARE message includes any *DCHs To Delete* IE, the Node B shall not include the referenced DCHs in the new configuration.

If all of the DCHs belonging to a set of co-ordinated DCHs are requested to be deleted, the Node B shall not include this set of co-ordinated DCHs in the new configuration.

#### **Physical Channel Modification:**

[FDD – If the RADIO LINK RECONFIGURATION PREPARE message includes an *UL DPCH Information* IE, then the Node B shall apply the parameters to the new configuration as follows:]

- [FDD - If the *UL DPCH Information* IE includes the *Uplink Scrambling Code* IE, the Node B shall apply this Uplink Scrambling Code to the new configuration.]
- [FDD - If the *UL DPCH Information* IE includes the *Min UL Channelisation Code Length* IE, the Node B shall apply the value in the new configuration. The Node B shall apply the contents of the *Max Number of UL DPDCHs* IE (if it is included) in the new configuration.]
- [FDD - If the *UL DPCH Information* IE includes the *UL SIR Target* IE, the Node B shall use the value for the UL inner loop power control when the new configuration is being used.]
- [FDD - If the *UL DPCH Information* IE includes the *Puncture Limit* IE, the Node B shall apply the value in the uplink of the new configuration.]
- [FDD - The Node B shall use the *TFCS* IE for the UL (if present) when reserving resources for the uplink of the new configuration. The Node B shall apply the new TFCS in the Uplink of the new configuration.]
- [FDD - If the *UL DPCH Information* IE includes the *UL DPCCH Slot Format* IE, the Node B shall set the new Uplink DPCCH Structure to the new configuration.]
- [FDD - If the *UL DPCH Information* IE includes the *Diversity Mode* IE, the Node B shall apply diversity according to the given value.]
- [FDD - If the *UL DPCH Information* IE includes an *SSDT Cell Identity Length* IE and/or an *S-Field Length* IE, the Node B shall apply the values in the new configuration.]

[FDD - If the RADIO LINK RECONFIGURATION PREPARE message includes the *DL DPCH Information* IE and the concerned Node B Communication Context is configured to use F-DPCH in the downlink in the old configuration, the Node B shall configure the concerned Node B Communication Context to use DPCH in the downlink in the new configuration.]

[FDD - If the RADIO LINK RECONFIGURATION PREPARE message includes the *DL DPCH Power Information* IE, the Node B shall use the information contained in it for the power settings of the DL DPCH. In particular, if the received *Inner Loop DL PC Status* IE is set to "Active", the Node B shall activate the inner loop DL power control for all RLs. If *Inner Loop DL PC Status* IE is set to "Inactive", the Node B shall deactivate the inner loop DL power control for all RLs according to ref. [10].]

[FDD - If the RADIO LINK RECONFIGURATION PREPARE message includes a *DL DPCH Information* IE, the Node B shall apply the parameters to the new configuration as follows:]

- [FDD - The Node B shall use the *TFCS* IE for the DL (if it is present) when reserving resources for the downlink of the new configuration. The Node B shall apply the new TFCS in the Downlink of the new configuration.]

- [FDD - If the *DL DPCH Information* IE includes the *TFCI Signalling Mode* IE or the *TFCI Presence* IE, the Node B shall use the information when building TFCIs in the new configuration.]
- [FDD - If the *DL DPCH Information* IE includes the *DL DPCH Slot Format* IE, the Node B shall set the new Downlink DPCH Structure to the new configuration.]
- [FDD - If the *DL DPCH Information* IE includes the *Multiplexing Position* IE, the Node B shall apply the indicated multiplexing type in the new configuration.]
- [FDD - If the *DL DPCH Information* IE includes the *Limited Power Increase* IE set to "Used", the Node B shall, if supported, use Limited Power Increase according to ref. [10] subclause 5.2.1 for the inner loop DL power control in the new configuration.]
- [FDD - If the *DL DPCH Information* IE includes the *Limited Power Increase* IE set to "Not Used", the Node B shall not use Limited Power Increase for the inner loop DL power control in the new configuration.]
- [FDD - If the *DL DPCH Information* IE includes the *PDSCH Code Mapping* IE, then the Node B shall apply the defined mapping between TFCI values and PDSCH channelisation codes.]
- [FDD - If the *DL DPCH Information* IE includes the *PDSCH RL ID* IE, then the Node B shall infer that the PDSCH for the specified user will be transmitted on the defined radio link.]

[FDD - If the RADIO LINK RECONFIGURATION PREPARE message includes the *F-DPCH Information* IE, the Node B shall configure the concerned Node B Communication Context to use F-DPCH in the downlink in the new configuration.]

[FDD – If the RADIO LINK RECONFIGURATION PREPARE message includes the *Transmission Gap Pattern Sequence Information* IE, the Node B shall store the new information about the Transmission Gap Pattern Sequences to be used in the new Compressed Mode Configuration. Any Transmission Gap Pattern Sequences already existing in the previous Compressed Mode Configuration are replaced by the new sequences once the new Compressed Mode Configuration has been activated. This new Compressed Mode Configuration shall be valid in the Node B until the next Compressed Mode Configuration is configured in the Node B or Node B Communication Context is deleted.]

#### **[FDD - E-DPCH Handling]:**

[FDD - If the *UL DPDCH Indicator For E-DCH Operation* IE is set to "UL DPDCH not present" the Min UL Channelisation Code Length IE, the Puncture Limit IE and the TFCS IE within the UL DPCH Information IE shall be ignored.]

[FDD - If the RADIO LINK RECONFIGURATION PREPARE message includes an *E-DPCH Information* IE, the Node B shall apply the parameters to the new configuration as follows:]

- [FDD - If the *E-DPCH Information* IE includes the *Min UL Channelisation Code Length For EDCH FDD* IE, the Node B shall apply the new Min UL Channelisation Code Length in the new configuration. The Node B shall apply the contents of the *Max Number Of E-DPDCHs* IE (if it is included) in the new configuration.]
- [FDD - If the *E-DPCH Information* IE includes the *Puncture Limit* IE, the Node B shall apply the value in the uplink of the new configuration]
- [FDD - If the *E-DPCH Information* IE includes the *E-TFCS* IE, the Node B shall use the *E-TFCS* IE for the E-DCH when reserving resources for the uplink of the new configuration. The Node B shall apply the new TFCS in the uplink of the new configuration.]
- [FDD - If the *E-DPCH Information* IE includes the *E-TTI* IE, the Node B shall use the value when the new configuration is being used.]

#### **[TDD – UL/DL CCTrCH Modification]**

[TDD – If the RADIO LINK RECONFIGURATION PREPARE message includes any *UL CCTrCH to Modify* or *DL CCTrCH to Modify* IE, then the Node B shall treat them each as follows:]

- [TDD – If the IE includes any of the *TFCS* IE, *TFCI coding* IE or *Puncture Limit* IE, the Node B shall apply these as the new values, otherwise the old values specified for this CCTrCH are still applicable.]
- [TDD – If the IE includes any *UL DPCH To Add* IE, *UL DPCH To Add LCR* IE, *DL DPCH To Add LCR* IE, or *DL DPCH To Add* IE, the Node B shall include this DPCH in the new configuration.]

- [TDD – If the IE includes any *UL DPCH To Delete* IE or *DL DPCH To Delete* IE, the Node B shall remove this DPCH in the new configuration.]
- [TDD – If the IE includes any *UL DPCH To Modify* IE or *DL DPCH To Modify* IE and includes any of the *Repetition Period* IE, *Repetition Length* IE or *TDD DPCH Offset* IE, or the message includes UL/DL Timeslot Information and includes any of the [3.84Mcps TDD - *Midamble Shift And Burst Type* IE], [1.28Mcps TDD - *Midamble Shift LCR* IE], or *TFCI Presence* IE or the message includes UL/DL Code information and includes [3.84Mcps TDD - *TDD Channelisation Code* IE], [1.28Mcps TDD - *TDD Channelisation Code LCR* IE] , [1.28Mcps TDD - *TDD UL DPCH Time Slot Format LCR* IE or *TDD DL DPCH Time Slot Format LCR* IE], the Node B shall apply these specified information elements as the new values, otherwise the old values specified for this DPCH configuration are still applicable.]
- [1.28Mcps TDD – If the *UL CCTrCH To Modify* IE includes the *UL SIR Target* IE, the Node B shall use the value for the UL inner loop power control according [19] and [21] when the new configuration is being used.]
- [1.28Mcps TDD - If the *UL CCTrCH to Modify* IE includes the *TDD TPC UL Step Size* IE, the Node B shall apply this value to the uplink TPC step size in the new configuration.]
- [TDD - If the *DL CCTrCH to Modify* IE includes the *TDD TPC DL Step Size* IE, the Node B shall apply this value to the downlink TPC step size in the new configuration.]

#### [TDD – UL/DL CCTrCH Addition]

[TDD – If the RADIO LINK RECONFIGURATION PREPARE message includes any *UL CCTrCH To Add* IE or *DL CCTrCH To Add* IE, the Node B shall include this CCTrCH in the new configuration.]

[TDD – If the *UL/DL CCTrCH To Add* IE includes any [3.84Mcps TDD - *UL/DL DPCH Information* IE] [1.28Mcps TDD - *UL/DL DPCH Information LCR* IE], the Node B shall reserve necessary resources for the new configuration of the UL/DL DPCH(s) according to the parameters given in the message.]

[TDD – If the RADIO LINK RECONFIGURATION PREPARE message includes *TDD TPC DL Step Size* IE within a *DL CCTrCH To Add* IE, the Node B shall set the downlink TPC step size of that CCTrCH to that value, otherwise the Node B shall set the TPC step size of that CCTrCH to the same value as the lowest numbered DL CCTrCH in the current configuration.]

[1.28Mcps TDD - If the *UL CCTrCH To Add* IE includes the *TDD TPC UL Step Size* IE, the Node B shall apply the uplink TPC step size in the new configuration.]

[1.28Mcps TDD –The Node B shall use the *UL SIR Target* IE in the *UL CCTrCH To Add* IE as the UL SIR value for the inner loop power control for this CCTrCH according [19] and [21] in the new configuration.]

#### [TDD – UL/DL CCTrCH Deletion]

[TDD – If the RADIO LINK RECONFIGURATION PREPARE message includes any UL or DL CCTrCH to be deleted , the Node B shall remove this CCTrCH in the new configuration.]

#### DL Power Control:

- [FDD - If the *RL Information* IE includes the *DL Reference Power* IEs and the power balancing is active, the Node B shall update the reference power of the power balancing in the indicated RL(s), if updating of power balancing parameters by the RADIO LINK RECONFIGURATION PREPARE message is supported, at the CFN in the RADIO LINK RECONFIGURATION COMMIT message, according to subclause 8.3.7, using the *DL Reference Power* IE. If the CFN modulo the value of the *Adjustment Period* IE is not equal to 0, the power balancing continues with the old reference power until the end of the current adjustment period, and the updated reference power shall be used from the next adjustment period.]

[FDD - If updating of power balancing parameters by the RADIO LINK RECONFIGURATION PREPARE message is supported by the Node B, the Node B shall include the *DL Power Balancing Updated Indicator* IE in the *RL Information Response* IE for each affected RL in the RADIO LINK RECONFIGURATION READY message.]

#### DSCH Addition/Modification/Deletion:

If the RADIO LINK RECONFIGURATION PREPARE message includes any *DSCH To Add*, *DSCH To Modify* or *DSCH To Delete* IE, then the Node B shall use this information to add/modify/delete the indicated DSCH channels to/from the radio link, in the same way as the DCH info is used to add/modify/release DCHs.

The Node B shall include in the RADIO LINK RECONFIGURATION READY message both the *Transport Layer Address IE* and the *Binding ID IE* for the transport bearer to be established for each DSCH.

[FDD – If the RADIO LINK RECONFIGURATION PREPARE message includes the *TFCI2 Bearer Information IE*, then the Node B shall support the establishment of a transport bearer on which the DSCH TFCI Signaling control frames shall be received if one does not already exist or shall apply the new values if such a bearer does already exist for this Node B Communication Context. The *Binding ID IE* and *Transport Layer Address IE* of any new bearer to be set up for this purpose shall be returned in the RADIO LINK RECONFIGURATION READY message. If the RADIO LINK RECONFIGURATION PREPARE message includes the *Transport Layer Address IE* and *Binding ID IE* in the *TFCI2 Bearer Information IE* the Node B may use the transport layer address and the binding identifier received from the CRNC when establishing a TFCI2 transport bearer. If the RADIO LINK RECONFIGURATION PREPARE message specifies that the TFCI2 transport bearer is to be deleted, then the Node B shall release the resources associated with that bearer in the new configuration.]

[FDD – If the RADIO LINK RECONFIGURATION PREPARE message includes the *TFCI2 Bearer Request Indicator IE* in the *TFCI2 Bearer Information IE* with the value "New Bearer Requested", the Node B shall establish a new transport bearer replacing the existing transport bearer on which the DSCH TFCI Signaling control frames shall be received. The *Binding ID IE* and *Transport Layer Address IE* of a new bearer to be set up for this purpose shall be returned in the RADIO LINK RECONFIGURATION READY message.]

[FDD – If the *TFCI Signalling Mode IE* within the RADIO LINK RECONFIGURATION PREPARE message indicates that there shall be a hard split on the TFCI field but a TFCI2 transport bearer has not already been set up and *TFCI2 Bearer Information IE* is not included in the message, then the Node B shall transmit the TFCI2 field with zero power in the new configuration.]

[FDD – If the *TFCI Signalling Mode IE* within the RADIO LINK RECONFIGURATION PREPARE message indicates that there shall be a hard split on the TFCI and the *TFCI2 Bearer Information IE* is included in the message, then the Node B shall transmit the TFCI2 field with zero power until Synchronisation is achieved on the TFCI2 transport bearer and the first valid DSCH TFCI Signalling control frame is received on this bearer in the new configuration (see ref. [24]).]

[FDD – If the RADIO LINK RECONFIGURATION PREPARE message includes the *Length Of TFCI2 IE*, then the Node B shall apply the length of TFCI (field 2) indicated in the message in the new configuration.]

[FDD – If the RADIO LINK RECONFIGURATION PREPARE message does not include the *Length Of TFCI2 IE* and the *Split Type IE* is present with the value "Hard", then the Node B shall assume the length of the TFCI (field 2) is 5 bits in the new configuration.]

[FDD - If the RADIO LINK RECONFIGURATION PREPARE message includes the *DSCH Common Information IE*, the Node B shall treat it as follows:]

- [FDD - If the *Enhanced DSCH PC Indicator IE* is included and set to "Enhanced DSCH PC Active in the UE ", the Node B shall activate enhanced DSCH power control in accordance with ref. [10] subclause 5.2.2, if supported, using either:]
  - [FDD - the *SSDT Cell Identity for EDSCHPC IE* in the *RL Information IE*, if the *SSDT Cell Identity IE* is not included in the *RL Information IE* or]
  - [FDD - the *SSDT Cell Identity IE* in the *RL Information IE*, if both the *SSDT Cell Identity IE* and the *SSDT Cell Identity for EDSCHPC IE* are included in the *RL Information IE*.]

[FDD - together with the *SSDT Cell Identity Length IE* in *UL DPCH Information IE*, and *Enhanced DSCH PC IE*, in the new configuration.]

[FDD - If the enhanced DSCH power control is activated and the TFCI power control in DSCH hard split mode is supported, the primary/secondary status determination in the enhanced DSCH power control is also applied to the TFCI power control in DSCH hard split mode.]

[FDD - If the RADIO LINK RECONFIGURATION PREPARE message includes the *Enhanced DSCH PC Indicator IE* set to "Enhanced DSCH PC not Active in the UE", the Node B shall deactivate enhanced DSCH power control in the new configuration.]

**[TDD – USCH Addition/Modification/Deletion]:**

- [TDD – If the RADIO LINK RECONFIGURATION PREPARE message includes USCH information for the USCHs to be added/modified/deleted then the Node B shall use this information to add/modify/delete the indicated USCH channels to/from the radio link, in the same way as the DCH info is used to add/modify/release DCHs.]
- [TDD – If the RADIO LINK RECONFIGURATION PREPARE message includes USCH information for the USCHs to be added/modified, if the *TNL QoS* IE is included and if ALCAP is not used, the Node B may use the *TNL QoS* IE to determine the transport bearer characteristics to apply between the Node B and the CRNC for the related USCHs.]
- [TDD – The Node B shall include in the RADIO LINK RECONFIGURATION READY message both the *Transport Layer Address* IE and the *Binding ID* IE for the transport bearer to be established for each USCH.]

#### RL Information:

If the RADIO LINK RECONFIGURATION PREPARE message includes the *RL Information* IE, the Node B shall treat it as follows:

- [FDD – When more than one DL DPDCH are assigned per RL, the segmented physical channel shall be mapped on to DL DPDCHs according to [8]. When *p* number of DL DPDCHs are assigned to each RL, the first pair of DL Scrambling Code and FDD DL Channelisation Code Number corresponds to "*PhCH number 1*", the second to "*PhCH number 2*", and so on until the *p*th to "*PhCH number p*".]
- [FDD – If the *RL Information* IE includes the *SSDT Indication* IE set to "SSDT Active in the UE", the Node B may activate SSDT using the *SSDT Cell Identity* IE in the new configuration.]
- [FDD – If the *RL Information* IE includes the *Qth Parameter* IE and the *SSDT Indication* IE set to "SSDT Active in the UE", the Node B shall use the *Qth Parameter* IE, if *Q*th signalling is supported, when SSDT is activated in the new configuration.]
- [FDD – If the *RL Information* IE includes the *SSDT Indication* IE set to "SSDT not Active in the UE", the Node B shall deactivate SSDT in the new configuration.]
- [FDD – If the *RL Information* IE includes a *DL Code Information* IE, the Node B shall apply the values in the new configuration.]
- [FDD – If the *RL Information* IE contains the *Transmission Gap Pattern Sequence Code Information* IE in the *DL Code Information* IE for any of the allocated DL Channelisation Codes, the Node B shall apply the alternate scrambling code as indicated whenever the downlink compressed mode method SF/2 is active in the new configuration.]
- [FDD - If the *RL Information* IE includes the *Maximum DL Power* and/or the *Minimum DL Power* IEs, the Node B shall apply the values in the new configuration. During compressed mode, the  $\delta P_{curr}$ , as described in ref.[10] subclause 5.2.1.3, shall be added to the maximum DL power for the associated compressed frame.]
- [3.84 Mcps TDD - If the *DL CCH To Add* IE is included, the Node B shall determine the maximum CCH DL power for the DCH type CCH by the following rule: If the *CCH Maximum DL Transmission Power* IE is included for that CCH, then the Node B shall use that power for the maximum CCH DL power, otherwise the maximum CCH DL power is the *Maximum Downlink Power* IE included in the *RL Information* IE. If no *Maximum Downlink Power* IE is included (even if *CCH Maximum DL Transmission Power* IEs are included), any maximum DL power stored for already existing DCH type CCHs for this Node B Communication Context shall be applied.]
- [3.84 Mcps TDD - If the *DL CCH To Add* IE is included, the Node B shall determine the minimum CCH DL power for the DCH type CCH by the following rule: If the *CCH Minimum DL Transmission Power* IE is included for that CCH, then the Node B shall use that power for the minimum CCH DL power, otherwise the minimum CCH DL power is the *Minimum Downlink Power* IE included in the *RL Information* IE. If no *Minimum Downlink Power* IE is included (even if *CCH Minimum DL Transmission Power* IEs are included), any minimum DL power stored for already existing DCH type CCHs for this Node B Communication Context shall be applied.]
- [3.84 Mcps TDD - If the *DL CCH To Modify* IE is included and *Maximum CCH DL Power to Modify* IE and/or *Minimum CCH DL Power to Modify* IE are included, the Node B shall apply the values in the new configuration for this DCH type CCH. If the *RL Information* IE includes *Maximum Downlink Power* and/or

the *Minimum Downlink Power* IEs, the Node B shall apply the values for all other DCH type CCTrCHs of the radio link.]

- [1.28 Mcps TDD - If the *DL CCTrCH To Add* IE is included, the Node B shall determine the maximum DL power for each timeslot within a DCH type CCTrCH by the following rule: If the *Maximum DL Power* IE is included in the *DL Timeslot Information LCR* IE for that timeslot, then the Node B shall use that power for the maximum DL power, otherwise the maximum DL power is the *Maximum Downlink Power* IE included in the *RL Information* IE. The Node B shall store this value and not transmit with a higher power on any applicable DL DPCH. If no *Maximum Downlink Power* IE is included, any maximum DL power stored for already existing timeslots for this Node B Communication Context shall be applied.]
- [1.28 Mcps TDD - If the *DL CCTrCH To Add* IE is included, the Node B shall determine the minimum DL power for each timeslot within a DCH type CCTrCH by the following rule: If the *Minimum DL Power* IE is included in the *DL Timeslot Information LCR* IE for that timeslot, then the Node B shall use that power for the minimum DL power, otherwise the minimum DL power is the *Minimum Downlink Power* IE included in the *RL Information* IE. The Node B shall store this value and not transmit with a lower power on any applicable DL DPCH. If no *Minimum Downlink Power* IE is included, any minimum DL power stored for already existing timeslots for this Node B Communication Context shall be applied.]
- [1.28 Mcps TDD - If the *DL CCTrCH To Modify* IE is included and *Maximum DL Power to Modify LCR* IE and/or *Minimum DL Power to Modify LCR* IE are included, the Node B shall apply the values in the new configuration for this timeslot, if the *RL Information* IE includes *Maximum Downlink Power* and/or the *Minimum Downlink Power* IEs, the Node B shall apply the values in the new configuration for all other timeslots.]
- [3.84Mcps TDD – If the *RL Information* IE includes the *Initial DL Transmission Power* IE, the Node B shall determine the initial CCTrCH DL power for each DCH type CCTrCH by the following rule: If the *CCTrCH Initial DL Transmission Power* IE is included for that CCTrCH, then the Node B shall use that power for the initial CCTrCH DL power, otherwise the initial CCTrCH DL power is the *Initial DL Transmission Power* IE included in the *RL Information* IE. The Node B shall apply the determined initial CCTrCH DL power to the transmission on each DPCH of the CCTrCH when starting transmission on a new CCTrCH until the UL synchronisation on the Uu interface is achieved for the CCTrCH. If no *Initial DL Transmission Power* IE is included with a new CCTrCH (even if *CCTrCH Initial DL Transmission Power* IEs are included), the Node B shall use any transmission power level currently used on already existing CCTrCHs when starting transmission for a new CCTrCH. No inner loop power control shall be performed during this period. The DL power shall then vary according to the inner loop power control (see ref.[21], subclause 4.2.3.4).]
- [3.84Mcps TDD - The initial power, maximum power, and minimum power for a DSCH type CCTrCH to be added or modified, shall be determined as follows:
  - If the DSCH type CCTrCH is paired with an uplink CCTrCH(s) for inner loop power control, the minimum, maximum and initial power for each PDSCH is determined in the same way as described above for DCH type CCTrCHs.
  - If the DSCH type CCTrCH is not paired with an uplink CCTrCH(s) for inner loop power control, the PDSCH transmission power is DSCH Data Frame Protocol signalled [24], with the maximum value determined in the same way as described above for DCH type CCTrCHs. The minimum and initial powers, however, are subject to control by the CRNC via the frame protocol].
- [1.28 Mcps TDD – If the *RL Information* IE includes the *Initial DL Transmission Power* IE, the Node B shall determine the initial DL power for each timeslot in a DCH type CCTrCH by the following rule: If the *Initial DL Transmission Power* IE is included in the *DL Timeslot Information LCR* IE, then the Node B shall use that power for the initial DL power, otherwise the initial DL power is the *Initial DL Transmission Power* IE included in the *RL Information* IE. The Node B shall apply the given power to the transmission on each DL DPCH and on each Time Slot of the CCTrCH when starting transmission until the UL synchronisation on the Uu interface is achieved for the CCTrCH. If no *Initial DL Transmission Power* IE is included, the Node B shall use any transmission power level currently used on already existing timeslots for this Node B Communication Context. No inner loop power control shall be performed during this period. The DL power shall then vary according to the inner loop power control (see ref.[21], subclause 5.1.2.4).]
- [1.28Mcps TDD - If the *RL Information* IE includes the *Initial DL Transmission Power* IE, the Node B shall determine the initial DL power for each timeslot within the DSCH type CCTrCH by the following rule: If both the *CCTrCH Initial DL Transmission Power* IE and the *DL Time Slot ISCP Info LCR* IE are included then the



Node B shall use that power for the PDSCH power, otherwise the PDSCH power is the *Initial DL Transmission Power* IE included in the *RL Information* IE. If *DL Time Slot ISCP info LCR* IE is present, the Node B shall use the indicated value when deciding the initial DL TX Power for each timeslot as specified in [21], it shall reduce the DL TX power in those downlink timeslots of the radio link where the interference is low, and increase the DL TX power in those timeslots where the interference is high, while keeping the total downlink power in the radio link unchanged. The Node B shall apply the given power to the transmission on each PDSCH and on each timeslot of the CCTrCH when starting transmission on a new CCTrCH until the UL synchronisation on the Uu interface is achieved for the CCTrCH. If no *Initial DL Transmission Power* IE is included with a new CCTrCH (even if *CCTrCH Initial DL Transmission Power* IEs are included), the Node B shall use any transmission power level currently used on already existing RL/timeslots when starting transmission for a new CCTrCH. No inner loop power control shall be performed during this period. The DL power shall then vary according to the inner loop power control (see ref.[21], subclause 5.1.2.4.)

- [1.28 Mcps TDD - If the *DL CCTrCH To Add* IE is included, the Node B shall determine the maximum DL power for each timeslot within a DSCH type CCTrCH by the following rule: If the *CCTrCH Maximum DL Transmission Power* IE is included then the Node B shall use that power for the maximum DL power, otherwise the maximum DL power is the *Maximum Downlink Power* IE included in the *RL Information* IE. The Node B shall store this value and not transmit with a higher power on any applicable DL PDSCH. If no *Maximum Downlink Power* IE is included, any maximum DL power stored for already existing timeslots for this Node B Communication Context shall be applied.]
- [1.28 Mcps TDD - If the *DL CCTrCH To Add* IE is included, the Node B shall determine the minimum DL power for each timeslot within a DSCH type CCTrCH by the following rule: If the *CCTrCH Minimum DL Transmission Power* IE is included then the Node B shall use that power for the minimum DL power, otherwise the minimum DL power is the *Minimum Downlink Power* IE included in the *RL Information* IE. The Node B shall store this value and not transmit with a lower power on any applicable DL PDSCH. If no *Minimum Downlink Power* IE is included, any minimum DL power stored for already existing timeslots for this Node B Communication Context shall be applied.]
- [1.28 Mcps TDD - If the *DL CCTrCH To Modify* IE is included and the *Maximum CCTrCH DL Power to Modify* IE and/or the *Minimum CCTrCH DL Power to Modify* IE are included, the Node B shall apply the values in the new configuration for this DSCH type CCTrCH, if the *RL Information* IE includes *Maximum Downlink Power* and/or the *Minimum Downlink Power* IEs, the Node B shall apply the values in the new configuration for all other timeslots.]
- [FDD- If the *RL Information* IE includes the *DL DPCH Timing Adjustment* IE, the Node B shall adjust the timing of the radio link accordingly in the new configuration.]
- [1.28Mcps TDD – If the *RL Information* IE message contains the *Uplink Synchronisation Parameters LCR* IE, the Node B shall use the indicated values of *Uplink Synchronisation Stepsize* IE and *Uplink Synchronisation Frequency* IE when evaluating the timing of the UL synchronisation.]

#### [TDD - PDSCH RL ID]:

- [TDD – If the RADIO LINK RECONFIGURATION PREPARE message includes the *PDSCH RL ID* IE then in the new configuration the Node B shall use the PDSCH and/or PUSCH in this radio link.]

#### Signalling bearer rearrangement:

If the RADIO LINK RECONFIGURATION PREPARE message includes the *Signalling Bearer Request Indicator* IE the Node B shall allocate a new Communication Control Port for the control of the Node B Communication Context and include the *Target Communication Control Port ID* IE in the RADIO LINK RECONFIGURATION READY message.

#### HS-DSCH Setup:

If the *HS-DSCH Information* IE is present in the RADIO LINK RECONFIGURATION PREPARE message, then:

- The Node B shall setup the requested HS-PDSCH resources on the Serving HS-DSCH Radio Link indicated by the *HS-PDSCH RL ID* IE.
- The Node B shall include the *HARQ Memory Partitioning* IE in the [FDD – *HS-DSCH FDD Information Response* IE] [TDD – *HS-DSCH TDD Information Response* IE] in the RADIO LINK RECONFIGURATION READY message.

- If the RADIO LINK RECONFIGURATION PREPARE message includes the *MAC-hs Guaranteed Bit Rate IE* for a Priority Queue in the *HS-DSCH MAC-d Flows Information IE* in the *HS-DSCH Information IE*, then the Node B shall use this information to optimise MAC-hs scheduling decisions for the related HSDPA Priority Queue.
- If the RADIO LINK RECONFIGURATION PREPARE message includes the *Discard Timer IE* for a Priority Queue in the *HS-DSCH MAC-d Flows Information IE* in the *HS-DSCH Information IE*, then the Node B shall use this information to discard out-of-date MAC-hs SDUs from the related HSDPA Priority Queue.
- The Node B shall include the *HS-DSCH Initial Capacity Allocation IE* in the [FDD – *HS-DSCH FDD Information Response IE*] [TDD – *HS-DSCH TDD Information Response IE*] in the RADIO LINK RECONFIGURATION READY message for every HS-DSCH MAC-d flow being established, if the Node B allows the CRNC to start transmission of MAC-d PDUs before the Node B has allocated capacity on user plane as described in [24].
- [FDD – If the RADIO LINK RECONFIGURATION PREPARE message includes the *HS-SCCH Power Offset IE* in the *HS-DSCH Information IE*, then the Node B may use this value to determine the HS-SCCH power. The HS-SCCH Power Offset should be applied for any HS-SCCH transmission to this UE.]
- [FDD – If the RADIO LINK RECONFIGURATION PREPARE message includes the *Measurement Power Offset IE* in the *HS-DSCH Information IE*, then the Node B shall use the measurement power offset as described in ref [10], subclause 6A.2.]
- [FDD – The Node B shall allocate HS-SCCH codes corresponding to the HS-DSCH and include the *HS-SCCH Specific Information Response IE* in the *HS-DSCH FDD Information Response IE* in the RADIO LINK RECONFIGURATION READY message.]
- [TDD – The Node B shall allocate HS-SCCH parameters corresponding to the HS-DSCH and include the [3.84Mcps TDD – *HS-SCCH Specific Information Response IE*] [1.28Mcps TDD – *HS-SCCH Specific Information Response LCR IE*] in the *HS-DSCH TDD Information Response IE* in the RADIO LINK RECONFIGURATION READY message.]
- [FDD – If the RADIO LINK RECONFIGURATION PREPARE message includes the *HARQ Preamble Mode IE* in the *HS-DSCH Information IE*, then the Node B shall use the indicated HARQ Preamble Mode as described in [10].]

#### **Intra-Node B Serving HS-DSCH Radio Link Change:**

If the RADIO LINK RECONFIGURATION PREPARE message includes the *HS-PDSCH RL ID IE*, this indicates the new Serving HS-DSCH Radio Link:

- In the new configuration the Node B shall de-allocate the HS-PDSCH resources of the old Serving HS-PDSCH Radio Link and allocate the HS-PDSCH resources for the new Serving HS-PDSCH Radio Link.
- The Node B may include the *HARQ Memory Partitioning IE* in the [FDD – *HS-DSCH FDD Information Response IE*] [TDD – *HS-DSCH TDD Information Response IE*] in the RADIO LINK RECONFIGURATION READY message.
- [FDD – The Node B shall allocate HS-SCCH codes corresponding to the HS-DSCH and include the *HS-SCCH Specific Information Response IE* in the *HS-DSCH FDD Information Response IE* in the RADIO LINK RECONFIGURATION READY message.]
- [TDD – The Node B shall allocate HS-SCCH parameters corresponding to the HS-DSCH and include the [3.84Mcps TDD – *HS-SCCH Specific Information Response IE*] [1.28Mcps TDD – *HS-SCCH Specific Information Response LCR IE*] in the *HS-DSCH TDD Information Response IE* in the RADIO LINK RECONFIGURATION READY message.]

#### **HS-DSCH Modification:**

If the RADIO LINK RECONFIGURATION PREPARE message includes the *HS-DSCH Information To Modify IE*, then:

- The Node B shall include the *HS-DSCH Initial Capacity Allocation IE* for every HS-DSCH MAC-d flow being modified for which a new transport bearer was requested with the *Transport Bearer Request Indicator IE*, if the

Node B allows the CRNC to start transmission of MAC-d PDUs before the Node B has allocated capacity on user plane as described in [24].

- If the RADIO LINK RECONFIGURATION PREPARE message includes the *MAC-hs Guaranteed Bit Rate IE* in the *HS-DSCH Information To Modify IE*, the Node B shall use this information to optimise MAC-hs scheduling decisions for the related HSDPA Priority Queue.
- If the RADIO LINK RECONFIGURATION PREPARE message includes the *Discard Timer IE* in the *HS-DSCH Information IE*, then the Node B shall use this information to discard out-of-date MAC-hs SDUs from the related HSDPA Priority Queue.
- If the RADIO LINK RECONFIGURATION PREPARE message includes the *MAC-hs Window Size IE* or *TI IE* in the *HS-DSCH Information To Modify IE*, then the Node B shall use the indicated values in the new configuration for the related HSDPA Priority Queue.
- If the RADIO LINK RECONFIGURATION PREPARE message includes the *MAC-d PDU Size Index IE* in the *Modify Priority Queue* choice, the Node B shall delete the previous list of MAC-d PDU Size Index values for the related HSDPA Priority Queue and use the MAC-d PDU Size Index values indicated in the *MAC-d PDU Size Index IE* in the new configuration.
- [FDD - If the RADIO LINK RECONFIGURATION PREPARE message includes the *CQI Feedback Cycle k IE*, the *CQI Repetition Factor IE*, the *ACK-NACK Repetition Factor IE*, the *ACK Power Offset IE*, the *NACK Power Offset IE* or the *CQI Power Offset IE* in the *HS-DSCH Information To Modify IE*, then the Node B shall use the indicated CQI Feedback Cycle k value, the CQI Repetition Factor or the ACK-NACK Repetition Factor, ACK Power Offset, the NACK Power Offset or the CQI Power Offset in the new configuration.]
- [FDD - If the *HS-SCCH Power Offset IE* is included in the *HS-DSCH Information To Modify IE*, the Node B may use this value to determine the HS-SCCH power. The HS-SCCH Power Offset should be applied for any HS-SCCH transmission to this UE.]
- [FDD - If the RADIO LINK RECONFIGURATION PREPARE message includes *Measurement Power Offset IE* in the *HS-DSCH Information IE* or the *HS-DSCH Information To Modify IE*, then the Node B shall use the measurement power offset as described in [10] subclause 6A.2.]
- [TDD – If the RADIO LINK RECONFIGURATION PREPARE message includes the *TDD ACK NACK Power Offset IE* in the *HS-DSCH Information To Modify IE*, the Node B shall use the indicated power offset in the new configuration.]
- [FDD - If the *HS-DSCH Information To Modify IE* includes the *HS-SCCH Code Change Grant IE*, then the Node B may modify the HS-SCCH codes corresponding to the HS-DSCH. The Node B shall then report the codes which are used in the new configuration specified in the *HS-SCCH Specific Information Response IE* in the RADIO LINK RECONFIGURATION READY message.]
- [TDD - If the *HS-DSCH Information To Modify IE* includes the *HS-SCCH Code Change Grant IE*, then the Node B may modify the HS-SCCH parameters corresponding to the HS-DSCH. The Node B shall then report the values for the parameters which are used in the new configuration specified in the [3.84Mcps TDD - *HS-SCCH Specific Information Response*] [1.28Mcps TDD - *HS-SCCH Specific Information Response LCR*] IEs in the RADIO LINK RECONFIGURATION READY message.]
- [FDD – If the RADIO LINK RECONFIGURATION PREPARE message includes the *HARQ Preamble Mode IE* in the *HS-DSCH Information To Modify IE*, then the Node B shall use the indicated HARQ Preamble Mode in the new configuration as described in [10].]

#### **HS-DSCH MAC-d Flow Addition/Deletion:**

If the RADIO LINK RECONFIGURATION PREPARE message includes any *HS-DSCH MAC-d Flows To Add* or *HS-DSCH MAC-d Flows To Delete* IEs, then the Node B shall use this information to add/delete the indicated HS-DSCH MAC-d flows. When an HS-DSCH MAC-d flow is deleted, all its associated Priority Queues shall also be removed.

If the RADIO LINK RECONFIGURATION PREPARE message includes an *HS-DSCH MAC-d Flows To Delete IE* requesting the deletion of all remaining HS-DSCH MAC-d flows for the Node B Communication Context, then the Node B shall delete the HS-DSCH configuration from the Node B Communication Context and release the HS-PDSCH resources.

If the RADIO LINK RECONFIGURATION PREPARE message includes the *HS-DSCH MAC-d Flows To Add* IE, then:

- The Node B shall include the *HS-DSCH Initial Capacity Allocation* IE in the RADIO LINK RECONFIGURATION READY message for every HS-DSCH MAC-d flow being added, if the Node B allows the CRNC to start transmission of MAC-d PDUs before the Node B has allocated capacity on user plane as described in [24].
- If the RADIO LINK RECONFIGURATION PREPARE message includes the *MAC-hs Guaranteed Bit Rate* IE in the *HS-DSCH MAC-d Flows To Add* IE, the Node B shall use this information to optimise MAC-hs scheduling decisions for the related HSDPA Priority Queue.
- If the RADIO LINK RECONFIGURATION PREPARE message includes the *Discard Timer* IE in the *HS-DSCH Information* IE, then the Node B shall use this information to discard out-of-date MAC-hs SDUs from the related HSDPA Priority Queue.
- The Node B may include the *HARQ Memory Partitioning* IE in the RADIO LINK RECONFIGURATION READY message.

#### **E-DCH Setup:**

If the *E-DCH FDD Information* IE is present in the RADIO LINK RECONFIGURATION PREPARE message:

- The Node B shall setup the requested E-DCH resources on the Radio Links indicated by the *E-DCH RL Indication* IE in the *RL Information* IE.
- If the RADIO LINK RECONFIGURATION PREPARE message includes the *MAC-es Guaranteed Bit Rate* IE in the *Data Description Indicator* IE in the *E-DCH FDD Information* IE, then the Node B shall use this information to optimise MAC-e scheduling decisions.
- If the RADIO LINK RECONFIGURATION PREPARE message includes the the *Maximum Number Of Transmissions For E-DCH* IE in the *E-DCH FDD Information* IE, then the Node B shall use this information to report if the maximum number of transmissions has elapsed.
- If the *TNL QoS* IE is included for a E-DCH MAC-d flow and if ALCAP is not used, the *TNL QoS* IE may be used by the Node B to determine the transport bearer characteristics to apply in the uplink for the related MAC-d flow.
- The Node B shall include the E-AGCH And E-RGCH/E-HICH FDD Scrambling Code IE, the E-RGCH/E-HICH Channelisation Code IE and the corresponding Sequence Number IEs in the *E-DCH FDD DL Control Channel Information* IE in the RADIO LINK RECONFIGURATION READY message for every RL indicated by the *E-DCH RL Indication* IE in the *RL Information* IE.
- If the RADIO LINK RECONFIGURATION PREPARE message includes the *Serving E-DCH RL* IE indicating that the Serving E-DCH RL is in this Node B, then the Node B shall allocate an E-RNTI identifier for the corresponding RL and include this E-RNTI identifier and the channelisation code of the corresponding E-AGCH in the *E-DCH FDD DL Control Channel Information* IE in the RADIO LINK RECONFIGURATION READY message.

#### **Serving E-DCH Radio Link Change:**

If the RADIO LINK RECONFIGURATION PREPARE message includes the *Serving E-DCH RL* IE, this indicates the new Serving E-DCH Radio Link:

- If the old Serving E-DCH RL is in this Node B, the Node B shall de-allocate the E-AGCH resources of the old Serving E-DCH Radio Link.
- If the new Serving E-DCH RL is in this Node B, the Node B shall allocate an E-RNTI identifier for the new Serving E-DCH Radio Link and include this identifier along with the channelisation code of the corresponding E-AGCH in the *E-DCH FDD DL Control Channel Information* IE in the RADIO LINK RECONFIGURATION READY message.

#### **E-DCH Modification:**

If the RADIO LINK RECONFIGURATION PREPARE message includes the *E-DCH FDD Information To Modify* IE, then:

- If the RADIO LINK RECONFIGURATION PREPARE message includes the *Data Description Indicator IE*, the Node B shall delete the previous list of Data Description Indicator values for this Node B Communication Context and use the DDI values indicated in the *Data Description Indicator IE* in the new configuration.

#### **E-DCH MAC-d Flow Addition/Deletion:**

If the RADIO LINK RECONFIGURATION PREPARE message includes any *E-DCH MAC-d Flows To Add* or *E-DCH MAC-d Flows To Delete* IEs, then the Node B shall use this information to add/delete the indicated E-DCH MAC-d flows. When an E-DCH MAC-d flow is deleted, all its associated configuration data shall also be removed.

If the RADIO LINK RECONFIGURATION PREPARE message includes an *E-DCH MAC-d Flows To Delete IE* requesting the deletion of all remaining E-DCH MAC-d flows for the UE Context, then the Node B shall delete the E-DCH configuration from the Node B Communication Context and release the E-DCH resources.

If the RADIO LINK RECONFIGURATION PREPARE message includes the *E-DCH MAC-d Flows To Add IE*, then:

- If the RADIO LINK RECONFIGURATION PREPARE message includes the *MAC-es Guaranteed Bit Rate IE* in the *E-DCH MAC-d Flows To Add IE*, the Node B shall use this information to optimise MAC-e scheduling decisions.
- If the RADIO LINK RECONFIGURATION PREPARE message includes the *Maximum Number of Transmissions for E-DCH IE* in the *E-DCH MAC-d Flows To Add IE*, then the Node B shall use this information to report if the maximum number of transmissions has elapsed.

#### **[FDD - Phase Reference Handling]:**

[FDD – If the RADIO LINK RECONFIGURATION PREPARE message includes the *Primary CPICH Usage For Channel Estimation IE*, the Node B shall assume that Primary CPICH usage for channel estimation has been reconfigured.]

[FDD – If the RADIO LINK RECONFIGURATION PREPARE message includes the *Secondary CPICH Information Change IE*, the Node B shall assume that Secondary CPICH usage for channel estimation has been reconfigured.]

#### **General**

If the RADIO LINK RECONFIGURATION PREPARE message includes the *Transport Layer Address IE* and *Binding ID IEs* in the *DSCHs To Modify*, *DSCHs To Add*, [TDD - *USCHs To Modify*, *USCHs To Add*], *HS-DSCH Information*, *HS-DSCH Information To Modify*, *HS-DSCH MAC-d Flows To Add*, *E-DCH Information*, *E-DCH Information To Modify*, *E-DCH MAC-d Flows To Add* or in the *RL Specific DCH Information IEs*, the Node B may use the transport layer address and the binding identifier received from the CRNC when establishing a transport bearer for any Transport Channel or MAC-d flow being added, or any Transport Channel or MAC-d flow being modified for which a new transport bearer was requested with the *Transport Bearer Request Indicator IE*.

If the requested modifications are allowed by the Node B and the Node B has successfully reserved the required resources for the new configuration of the Radio Link(s), it shall respond to the CRNC with the RADIO LINK RECONFIGURATION READY message. When this procedure has been completed successfully there exists a Prepared Reconfiguration, as defined in subclause 3.1.

The Node B shall include in the RADIO LINK RECONFIGURATION READY message the *Transport Layer Address IE* and the *Binding ID IE* for any Transport Channel or MAC-d flow being added or any Transport Channel or MAC-d flow being modified for which a new transport bearer was requested with the *Transport Bearer Request Indicator IE*.

In the case of a set of co-ordinated DCHs requiring a new transport bearer on the Iub interface, the *Transport Layer Address IE* and the *Binding ID IE* in the *DCH Information Response IE* shall be included only for one of the DCH in the set of co-ordinated DCHs.

In the case of a Radio Link being combined with another Radio Link within the Node B, the *Transport Layer Address IE* and the *Binding ID IE* in the *DCH Information Response IE* shall be included only for one of the combined Radio Links.

### 8.3.2.3 Unsuccessful Operation

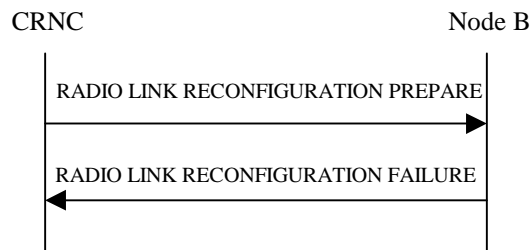

**Figure 31: Synchronised Radio Link Reconfiguration Preparation procedure, Unsuccessful Operation**

If the Node B cannot reserve the necessary resources for all the new DCHs of one set of co-ordinated DCHs requested to be added, it shall regard the Synchronised Radio Link Reconfiguration Preparation procedure as having failed.

If the requested Synchronised Radio Link Reconfiguration Preparation procedure fails for one or more RLS, the Node B shall send the RADIO LINK RECONFIGURATION FAILURE message to the CRNC, indicating the reason for failure.

Typical cause values are as follows:

#### Radio Network Layer Cause

- UL SF not supported
- DL SF not supported
- Downlink Shared Channel Type not supported
- Uplink Shared Channel Type not supported
- CM not supported
- Number of DL codes not supported
- Number of UL codes not supported
- RL Timing Adjustment not supported
- HARQ Preamble Mode not supported
- [F-DPCH not supported.](#)

#### Transport Layer Cause

- Transport Resources Unavailable

#### Miscellaneous Cause

- O&M Intervention
- Control processing overload
- HW failure

### 8.3.2.4 Abnormal Conditions

If only a subset of all the DCHs belonging to a set of co-ordinated DCHs is requested to be deleted, the Node B shall regard the Synchronised Radio Link Reconfiguration Preparation procedure as having failed and shall send the RADIO LINK RECONFIGURATION FAILURE message to the CRNC.

If more than one DCH of a set of co-ordinated DCHs has the *QE-Selector* IE set to "selected" [TDD – or no DCH of a set of co-ordinated DCHs has the *QE-Selector* IE set to "selected"], the Node B shall regard the Synchronised Radio Link Reconfiguration Preparation procedure as failed and shall respond with a RADIO LINK RECONFIGURATION FAILURE message.

[FDD - If the *RL Information* IE includes the *SSDT Indication* IE set to "SSDT Active in the UE" and SSDT is not active in the current configuration, the Node B shall regard the Synchronised Radio Link Reconfiguration Preparation procedure as failed if the *UL DPCH Information* IE does not include the *SSDT Cell Identity Length* IE. In this case, it shall respond with a RADIO LINK RECONFIGURATION FAILURE message.]

If the RADIO LINK RECONFIGURATION PREPARE message includes a *DCHs To Modify* IE or *DCHs To Add* IE with multiple *DCH Specific Info* IEs, and if the DCHs in the *DCHs To Modify* IE or *DCHs To Add* IE do not have the same *Transmission Time Interval* IE in the *Semi-Static Transport Format Information* IE, then the Node B shall reject the procedure using the RADIO LINK RECONFIGURATION FAILURE message.

[FDD - If the *RL Information* IE includes the *DL Reference Power* IE, but the power balancing is not active in the indicated RL(s), the Node B shall regard the Synchronised Radio Link Reconfiguration Preparation procedure as having failed and the Node B shall respond with the RADIO LINK RECONFIGURATION FAILURE message with the cause value "Power Balancing status not compatible".]

[FDD - If the power balancing is active with the Power Balancing Adjustment Type of the Node B Communication Context set to "Common" in the existing RL(s) but the RADIO LINK RECONFIGURATION PREPARE message IE includes more than one *DL Reference Power* IE, the Node B shall regard the Synchronised Radio Link Reconfiguration Preparation procedure as having failed and the Node B shall respond with the RADIO LINK RECONFIGURATION FAILURE message with the cause value "Power Balancing status not compatible".]

[FDD – If the RADIO LINK RECONFIGURATION PREPARE message includes the *Length Of TFCI2* IE but the *TFCI Signalling Option* IE is set to "Normal", then the Node B shall reject the procedure using the RADIO LINK RECONFIGURATION FAILURE message.]

[FDD – If the RADIO LINK RECONFIGURATION PREPARE message does not include the *Length Of TFCI2* IE but the *Split Type* IE is set to "Logical", then the Node B shall reject the procedure using the RADIO LINK RECONFIGURATION FAILURE message.]

[FDD – If the RADIO LINK RECONFIGURATION PREPARE message includes the *Split Type* IE set to the value "Hard" and the *Length Of TFCI2* IE set to the value "1", "2", "5", "8", "9" or "10", then the Node B shall reject the procedure using the RADIO LINK RECONFIGURATION FAILURE message.]

If the RADIO LINK RECONFIGURATION PREPARE message contains the *Transport Layer Address* IE or the *Binding ID* IE when establishing a transport bearer for any Transport Channel or HS-DSCH MAC-d flow being added, or any Transport Channel or HS-DSCH MAC-d flow being modified for which a new transport bearer was requested with the *Transport Bearer Request Indicator* IE, and not both are present for a transport bearer intended to be established, the Node B shall reject the procedure using the RADIO LINK RECONFIGURATION FAILURE message.

[FDD – If the RADIO LINK RECONFIGURATION PREPARE message is to modify UE channel estimation information for an existing RL and the modification is not allowed according to [10] subclause 4.3.2.1, the Node B shall reject the procedure using the RADIO LINK RECONFIGURATION FAILURE message.]

If the RADIO LINK RECONFIGURATION PREPARE message contains any of the *HS-DSCH Information To Modify* IE, *HS-DSCH MAC-d Flows To Add* IE or *HS-DSCH MAC-d Flows To Delete* IE in addition to the *HS-DSCH Information* IE, the Node B shall reject the procedure using the RADIO LINK RECONFIGURATION FAILURE message.

If the RADIO LINK RECONFIGURATION PREPARE message contains any of the *HS-DSCH Information To Modify* IE, *HS-DSCH MAC-d Flows To Add* IE, *HS-DSCH MAC-d Flows To Delete* IE or *HS-PDSCH RL ID* IE and the Serving HS-DSCH Radio Link is not in the Node B, the Node B shall reject the procedure using the RADIO LINK RECONFIGURATION FAILURE message.

If the RADIO LINK RECONFIGURATION PREPARE message includes the *HS-DSCH Information* IE and does not include the *HS-PDSCH RL-ID* IE, the Node B shall reject the procedure using the RADIO LINK RECONFIGURATION FAILURE message.

If the RADIO LINK RECONFIGURATION PREPARE message includes the *HS-DSCH Information To Modify* IE deleting the last remaining Priority Queue of an HS-DSCH MAC-d Flow, the Node B shall reject the procedure using the RADIO LINK RECONFIGURATION FAILURE message.

If the RADIO LINK RECONFIGURATION PREPARE message includes the *HS-PDSCH RL-ID* IE indicating a Radio Link not existing in the Node B Communication Context, the Node B shall reject the procedure using the RADIO LINK RECONFIGURATION FAILURE message.

[TDD - If multiple radio links exist within the Node B Communication Context and the RADIO LINK RECONFIGURATION PREPARE message does not include a *RL ID IE* within each *UL DPCH To Add Per RL IE*, *DL DPCH To Add Per RL IE*, *UL DPCH To Modify Per RL IE*, and *DL DPCH To Modify Per RL IE* that is present in the message, the Node B shall reject the procedure using the RADIO LINK RECONFIGURATION FAILURE message.]

If the RADIO LINK RECONFIGURATION PREPARE message contains any of the *HS-DSCH Information IE*, *HS-DSCH Information To Modify IE*, or *HS-DSCH MAC-d Flows To Add IE* and if in the new configuration the Priority Queues associated with the same *HS-DSCH MAC-d Flow ID IE* have the same *Scheduling Priority Indicator IE* value, the Node B shall reject the procedure using the RADIO LINK RECONFIGURATION FAILURE message.

[FDD - If the RADIO LINK RECONFIGURATION PREPARE message contains the *F-DPCH Information IE* and the *DL DPCH Information IE*, then the Node B shall reject the procedure using the RADIO LINK RECONFIGURATION FAILURE message.]

[FDD - If the concerned the Node B Communication Context is configured to use DPCH in the downlink in the old configuration and the RADIO LINK RECONFIGURATION PREPARE message includes the *DL DPCH Power Information IE*, then the Node B shall reject the procedure using the RADIO LINK RECONFIGURATION FAILURE message.]

[FDD - If the concerned Node B Communication Context is configured to use F-DPCH in the downlink in the old configuration and the RADIO LINK RECONFIGURATION PREPARE message includes at least one but not all of the *TFCs IE*, *DL DPCH Slot Format IE*, *TFCI Signalling Mode IE*, *Multiplexing Position IE*, *Limited Power Increase IE* and *DL DPCH Power Information IE* in the *DL DPCH Information IE*, then the Node B shall reject the procedure using the RADIO LINK RECONFIGURATION FAILURE message.]

[FDD - If the concerned Node B Communication Context is configured to use F-DPCH in the downlink in the old configuration, if the RADIO LINK RECONFIGURATION PREPARE message includes the *DL DPCH Information IE*, if at least one Transmission Gap Pattern Sequence is configured with an SF/2 downlink compressed mode method in the new Compressed Mode Configuration and if the RADIO LINK RECONFIGURATION PREPARE message does not include the *Transmission Gap Pattern Sequence Code Information IE* for each DL Channelisation Code, then the Node B shall reject the procedure using the RADIO LINK RECONFIGURATION FAILURE message.]



### 8.3.3 Synchronised Radio Link Reconfiguration Commit

#### 8.3.3.1 General

This procedure is used to order the Node B to switch to the new configuration for the Radio Link(s) within the Node B, previously prepared by the Synchronised Radio Link Reconfiguration Preparation procedure.

The message shall use the Communication Control Port assigned for this Node B Communication Context.

#### 8.3.3.2 Successful Operation

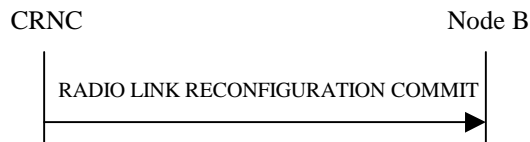

**Figure 32: Synchronised Radio Link Reconfiguration Commit procedure, Successful Operation**

The Node B shall switch to the new configuration previously prepared by the Synchronised Radio Link Reconfiguration Preparation procedure at the next coming CFN with a value equal to the value requested by the CRNC in the *CFN* IE (see ref.[17] subclause 9.4) when receiving the RADIO LINK RECONFIGURATION COMMIT message from the CRNC.

[FDD – If the *Active Pattern Sequence Information* IE is included in the RADIO LINK RECONFIGURATION COMMIT message, the *CM Configuration Change CFN* IE in the *Active Pattern Sequence Information* IE shall be ignored by the Node B.]

When this procedure has been completed the Prepared Reconfiguration does not exist any more, see subclause 3.1.

In the case of a transport channel modification for which a new transport bearer was requested and established, the switch to the new transport bearer shall also take place at the indicated CFN. The detailed frame protocol handling during transport bearer replacement is described in [16], subclause 5.10.1 and in [24], subclause 5.8.2.

In the case of a signalling bearer re-arrangement, the new Communication Control Port shall be used once the Node B has received the RADIO LINK RECONFIGURATION COMMIT message via the old Communication Control Port.

[FDD – If the RADIO LINK RECONFIGURATION COMMIT includes the *Active Pattern Sequence Information* IE, the Node B shall deactivate all the ongoing Transmission Gap Pattern Sequences at the *CFN* IE. From that moment on, all Transmission Gap Pattern Sequences included in *Transmission Gap Pattern Sequence Status* IE repetitions shall be started when the indicated *TGCFN* IE elapses. The *CFN* IE and *TGCFN* IE for each sequence refer to the next coming CFN with that value. If the values of the *CFN* IE and the *TGCFN* IE are equal, the concerned Transmission Gap Pattern Sequence shall be started immediately at the CFN with a value equal to the value received in the *CFN* IE.]

[FDD - If the RADIO LINK RECONFIGURATION COMMIT message includes the *Active Pattern Sequence Information* IE and the concerned Node B Communication Context is configured to use F-DPCH in the downlink, the Node B shall ignore, when activating the Transmission Gap Pattern Sequence(s), the downlink compressed mode method information, if existing, for the concerned Transmission Gap Pattern Sequence(s) in the Compressed Mode Configuration.]

#### 8.3.3.3 Abnormal Conditions

If a new transport bearer is required for the new reconfiguration and it is not available at the requested CFN, the Node B shall initiate the Radio Link Failure procedure.

## 8.3.5 Unsynchronised Radio Link Reconfiguration

### 8.3.5.1 General

The Unsynchronised Radio Link Reconfiguration procedure is used to reconfigure Radio Link(s) related to one UE-UTRAN connection within a Node B.

The Unsynchronised Radio Link Reconfiguration procedure is used when there is no need to synchronise the time of the switching from the old to the new configuration in one Node B used for a UE-UTRAN connection with any other Node B also used for the UE-UTRAN connection.

The Unsynchronised Radio Link Reconfiguration procedure shall not be initiated if a Prepared Reconfiguration exists, as defined in subclause 3.1.

### 8.3.5.2 Successful Operation

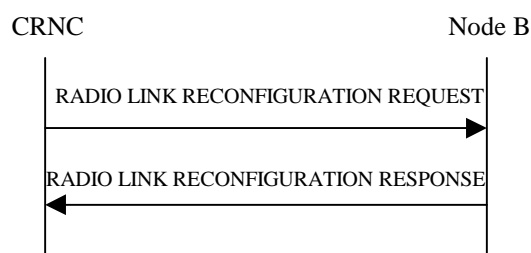

**Figure 34: Unsynchronised Radio Link Reconfiguration Procedure, Successful Operation**

The Unsynchronised Radio Link Reconfiguration procedure is initiated by the CRNC by sending the RADIO LINK RECONFIGURATION REQUEST message to the Node B. The message shall use the Communication Control Port assigned for this Node B Communication Context.

Upon reception, the Node B shall modify the configuration of the Radio Link(s) according to the parameters given in the message. Unless specified below, the meaning of parameters is specified in other specifications.

The Node B shall prioritise resource allocation for the RL(s) to be modified according to Annex A.

#### **DCH Modification:**

If the RADIO LINK RECONFIGURATION REQUEST message includes any *DCHs To Modify* IE then the Node B shall treat them each as follows:

- If the *DCHs To Modify* IE includes the *Frame Handling Priority* IE, the Node B should store this information for this DCH in the new configuration. The received Frame Handling Priority should be used when prioritising between different frames in the downlink on the Uu interface in congestion situations within the Node B once the new configuration has been activated.
- If the *DCHs To Modify* IE includes the *TNL QoS* IE for a DCH or a set of co-ordinated DCHs to be modified and if ALCAP is not used, the Node B may store this information for this DCH in the new configuration. The *TNL QoS* IE may be used to determine the transport bearer characteristics to apply for the uplink between the Node B and the CRNC for the related DCH or set of co-ordinated DCHs.
- If the *DCHs To Modify* IE includes the *Transport Format Set* IE for the UL, the Node B shall apply the new Transport Format Set in the Uplink of this DCH in the new configuration.
- If the *DCHs To Modify* IE includes the *Transport Format Set* IE for the DL, the Node B shall apply the new Transport Format Set in the Downlink of this DCH in the new configuration.
- If the *DCHs To Modify* IE includes the *Allocation/Retention Priority* IE for a DCH, the Node B shall apply the new Allocation/Retention Priority to this DCH in the new configuration according to Annex A.
- If the *DCHs To Modify* IE includes multiple *DCH Specific Info* IEs, then the Node B shall treat the DCHs in the *DCHs To Modify* IE as a set of co-ordinated DCHs. The Node B shall include these DCHs in the new configuration only if it can include all of them in the new configuration.

- If the *DCHs To Modify* IE includes the *UL FP Mode* IE for a DCH or a set of co-ordinated DCHs, the Node B shall apply the new FP Mode in the Uplink of the user plane for the DCH or the set of co-ordinated DCHs in the new configuration.
- If the *DCHs To Modify* IE includes the *ToAWS* IE for a DCH or a set of co-ordinated DCHs, the Node B shall apply the new ToAWS in the user plane for the DCH or the set of co-ordinated DCHs in the new configuration.
- If the *DCHs To Modify* IE includes the *ToAWE* IE for a DCH or a set of co-ordinated DCHs, the Node B shall apply the new ToAWE in the user plane for the DCH or the set of co-ordinated DCHs in the new configuration.
- [TDD – If the RADIO LINK RECONFIGURATION REQUEST message includes the *CCTrCH ID* IE for the DL of a DCH to be modified, the Node B shall apply the new CCTrCH ID in the Downlink of this DCH in the new configuration.]
- [TDD – If the RADIO LINK RECONFIGURATION REQUEST message includes the *CCTrCH ID* IE for the UL of a DCH to be modified, the Node B shall apply the new CCTrCH ID in the Uplink of this DCH in the new configuration.]

#### DCH Addition:

If the RADIO LINK RECONFIGURATION REQUEST message includes any *DCH To Add* IE, the Node B shall reserve necessary resources for the new configuration of the Radio Link(s) according to the parameters given in the message and include these DCHs in the new configuration. In particular:

- If a *DCHs To Add* IE includes multiple *DCH Specific Info* IEs for a DCH to be added, the Node B shall treat the DCHs in the *DCHs To Add* IE as a set of co-ordinated DCHs. The Node B shall include these DCHs in the new configuration only if it can include all of them in the new configuration.
- If the *DCH Specific Info* IE includes the *Unidirectional DCH Indicator* IE set to "Uplink DCH only", the Node B shall ignore the *Transport Format Set* IE for the downlink for this DCH. As a consequence this DCH is not included as a part of the downlink CCTrCH.
- [TDD – If the *DCH Specific Info* IE includes the *Unidirectional DCH Indicator* IE set to "Downlink DCH only", the Node B shall ignore the *Transport Format Set* IE for the uplink for this DCH. As a consequence this DCH is not included as a part of the uplink CCTrCH.]
- [FDD - For DCHs which do not belong to a set of co-ordinated DCHs with the *QE-Selector* IE set to "selected", the Node B shall use the Transport channel BER from that DCH as the base for the QE in the UL data frames. If no Transport channel BER is available for the selected DCH, the Physical channel BER shall be used for the QE [16]. If the *QE-Selector* IE is set to "non-selected", the Physical channel BER shall be used for the QE in the UL data frames, ref. [16].]
- For a set of co-ordinated DCHs, the Node B shall use the Transport channel BER from the DCH with the *QE-Selector* IE set to "selected" as the QE in the UL data frames [16]. [FDD – If no Transport channel BER is available for the selected DCH, the Physical channel BER shall be used for the QE [16]. If all DCHs have the *QE-Selector* IE set to "non-selected", the Physical channel BER shall be used for the QE [16].]
- The Node B should store the *Frame Handling Priority* IE received for a DCH to be added in the new configuration. The received Frame Handling Priority should be used when prioritising between different frames in the downlink on the Uu interface in congestion situations within the Node B once the new configuration has been activated.
- If the *TNL QoS* IE is included for a DCH or a set of co-ordinated DCHs and if ALCAP is not used, the Node B may store this information for this DCH in the new configuration. The *TNL QoS* IE may be used to determine the transport bearer characteristics to apply for the uplink between the Node B and the CRNC for the related DCH or set of co-ordinated DCHs.
- The Node B shall use the included *UL FP Mode* IE for a DCH or a set of co-ordinated DCHs to be added as the new FP Mode in the Uplink of the user plane for the DCH or the set of co-ordinated DCHs in the new configuration.
- The Node B shall use the included *ToAWS* IE for a DCH or a set of co-ordinated DCHs to be added as the new Time of Arrival Window Startpoint in the user plane for the DCH or the set of co-ordinated DCHs in the new configuration.

- The Node B shall use the included *ToAWE* IE for a DCH or a set of co-ordinated DCHs to be added as the new Time of Arrival Window Endpoint in the user plane for the DCH or the set of co-ordinated DCHs in the new configuration.
- [TDD – If the RADIO LINK RECONFIGURATION REQUEST message includes the *CCTrCH ID* IE for the DL of a DCH to be added, the Node B shall apply the new CCTrCH ID in the downlink of this DCH in the new configuration.]
- [TDD – If the RADIO LINK RECONFIGURATION REQUEST message includes the *CCTrCH ID* IE for the UL of a DCH to be added, the Node B shall apply the new CCTrCH ID in the Uplink of this DCH in the new configuration.]

#### **DCH Deletion:**

If the RADIO LINK RECONFIGURATION REQUEST message includes any DCH to be deleted from the Radio Link(s), the Node B shall not include this DCH in the new configuration.

If all of the DCHs belonging to a set of co-ordinated DCHs are requested to be deleted, the Node B shall not include this set of co-ordinated DCHs in the new configuration.

#### **[FDD - Physical Channel Modification]:**

[FDD - If the RADIO LINK RECONFIGURATION REQUEST message includes an *UL DPCH Information* IE, then the Node B shall apply the parameters to the new configuration as follows:]

- [FDD - If the *UL DPCH Information* IE includes the *TFCS* IE for the UL, the Node B shall apply the new TFCS in the Uplink of the new configuration.]

[FDD – If the RADIO LINK RECONFIGURATION REQUEST message includes a *DL DPCH Information* IE, then the Node B shall apply the parameters to the new configuration as follows:]

- [FDD – If the *DL DPCH Information* IE includes on the *TFCS* IE for the DL, the Node B shall apply the new TFCS in the Downlink of the new configuration.]
- [FDD – If the *DL DPCH Information* IE includes the *TFCI Signalling Mode* IE, the Node B shall use the information when building TFCIs in the new configuration.
  - [FDD – If the *Length Of TFCI2* IE is included, then the Node B shall apply the length of TFCI (field 2) indicated in the message in the new configuration.]
  - [FDD – If the *Length Of TFCI2* IE is not included and the *Split Type* IE is present with the value "Hard", then the Node B shall assume the value of the TFCI (field 2) is 5 bits in the new configuration.]
- [FDD – If the *DL DPCH Information* IE includes the *Limited Power Increase* IE set to "Used", the Node B shall, if supported, use Limited Power Increase according to ref. [10] subclause 5.2.1 for the inner loop DL power control in the new configuration.]
- [FDD – If the *DL DPCH Information* IE includes the *Limited Power Increase* IE set to "Not Used", the Node B shall not use Limited Power Increase for the inner loop DL power control in the new configuration.]

[FDD – If the RADIO LINK RECONFIGURATION REQUEST message includes the *Transmission Gap Pattern Sequence Information* IE, the Node B shall store the new information about the Transmission Gap Pattern Sequences to be used in the new Compressed Mode Configuration. Any Transmission Gap Pattern Sequences already existing in the previous Compressed Mode Configuration are replaced by the new sequences once the new Compressed Mode Configuration has been activated. This new Compressed Mode Configuration shall be valid in the Node B until the next Compressed Mode Configuration is configured in the Node B or Node B Communication Context is deleted.]

#### **[FDD - E-DPCH Handling]:**

[FDD - If the *UL DPDCH Indicator F or E-DCH Operation* IE is set to "UL DPDCH not present" the *Min UL Channelisation Code Length* IE, the *Puncture Limit* IE and the *TFCS* IE within the *UL DPCH Information* IE shall be ignored.]

[FDD - If the RADIO LINK RECONFIGURATION REQUEST message includes an *E-DPCH Information* IE which contains the *E-TFCS* IE, the Node B shall use the *E-TFCS* IE for the E-DCH when reserving resources for the uplink of the new configuration. The Node B shall apply the new TFCS in the uplink of the new configuration.]

**[TDD – UL/DL CCTrCH Modification]**

[TDD – If the RADIO LINK RECONFIGURATION REQUEST message includes any *UL CCTrCH To Modify* IE or *DL CCTrCH To Modify* IE in the Radio Link(s), the Node B shall reserve necessary resources for the new configuration of the Radio Link(s) according to the parameters given in the message.]

[TDD – If the *UL CCTrCH To Modify* IE or *DL CCTrCH To Modify* IE includes *TFCS* IE and/or *Puncture Limit* IE, the Node B shall apply these as the new values, otherwise the old values specified for this CCTrCH are still applicable.]

[1.28Mcps TDD - If the *UL CCTrCH To Modify* IE includes *UL SIR Target* IE, the Node B shall apply this value as the new configuration and use it for the UL inner loop power control according [19] and [21].]

**[TDD – UL/DL CCTrCH Deletion]**

[TDD – If the RADIO LINK RECONFIGURATION REQUEST message includes any *UL CCTrCH To Delete* IE or *DL CCTrCH To Delete* IE, the Node B shall not include this CCTrCH in the new configuration.]

**DL Power Control:**

- [FDD – If the *Radio Link Information* IE includes the *DL Reference Power* IE and the power balancing is active, the Node B shall update the reference power of the power balancing in the indicated RL(s), if updating of power balancing parameters by the RADIO LINK RECONFIGURATION REQUEST message is supported, using the *DL Reference Power* IE in the RADIO LINK RECONFIGURATION REQUEST message. The updated reference power shall be used from the next adjustment period.]

[FDD – If updating of power balancing parameters by the RADIO LINK RECONFIGURATION REQUEST message is supported by the Node B, the Node B shall include the *DL Power Balancing Updated Indicator* IE in the *RL Information Response* IE for each affected RL in the RADIO LINK RECONFIGURATION RESPONSE message.]

**RL Information:**

If the RADIO LINK RECONFIGURATION REQUEST message includes the *RL Information* IE, the Node B shall treat it as follows:

- [FDD - If the *RL Information* IE includes the *Maximum DL Power* IE, the Node B shall apply this value to the new configuration and not transmit with a higher power on any Downlink DPCH [or on the F-DPCH](#) of the Radio Link once the new configuration is being used. During compressed mode, the  $\delta P_{curr}$  as described in ref.[10] subclause 5.2.1.3, shall be added to the maximum DL power for the associated compressed frame.]
- [FDD - If the *RL Information* IE includes the *Minimum DL Power* IE, the Node B shall apply this value to the new configuration and never transmit with a lower power on any Downlink Channelisation Code [or on the F-DPCH](#) of the Radio Link once the new configuration is being used.]
- [3.84 Mcps TDD - If the *CCTrCH Maximum DL Transmission Power* IE and/or the *CCTrCH Minimum DL Transmission Power* IE are included, the Node B shall apply the values in the new configuration for this DCH type CCTrCH, if the *RL Information* IE includes *Maximum Downlink Power* and/or the *Minimum Downlink Power* IEs, the Node B shall apply the values in the new configuration for all other DCH type CCTrCHs.]
- [3.84 Mcps TDD – The maximum power and minimum power for a DSCH type CCTrCH to be modified, shall be determined as follows:
  - If the DSCH type CCTrCH is paired with an uplink CCTrCH(s) for inner loop power control, the minimum and maximum power for each PDSCH is determined in the same way as described above for DCH type CCTrCHs.
  - If the DSCH type CCTrCH is not paired with an uplink CCTrCH(s) for inner loop power control, the PDSCH transmission power is DSCH Data Frame Protocol signalled [24], with the maximum value determined in the same way as described above for DCH type CCTrCHs. The minimum power, however, is subject to control by the CRNC via the frame protocol].
- [1.28 Mcps TDD - If *Maximum DL Power* IE and/or *Minimum DL Power* IE are included within *DL Timeslot Information LCR* IE, the the Node B shall apply the values in the new configuration for this timeslot within a DCH type CCTrCH, if the *RL Information* IE includes *Maximum Downlink Power* and/or the *Minimum Downlink Power* IEs, the Node B shall apply the values in the new configuration for all other timeslots.]

- [1.28 Mcps TDD - If the *CCTrCH Maximum DL Transmission Power* IE and/or the *CCTrCH Minimum DL Transmission Power* IE are included, the Node B shall apply the values in the new configuration for this DSCH type CCTrCH, if the *RL Information* IE includes the *Maximum Downlink Power* and/or the *Minimum Downlink Power* IEs, the Node B shall apply the values in the new configuration for other timeslots.]
- [FDD – If [the concerned Node B Communication Context is configured to use DPCH in the downlink and if](#) the *RL Information* IE contains the *Transmission Gap Pattern Sequence Code Information* IE in the *DL Code Information* IE for any of the allocated DL Channelisation Codes, the Node B shall apply the alternate scrambling code as indicated whenever the downlink compressed mode method SF/2 is active in the new configuration.]
- [1.28Mcps TDD – If the *RL Information* IE contains the *Uplink Synchronisation Parameters LCR* IE, the Node B shall use the indicated values of *Uplink Synchronisation Stepsize* IE and *Uplink Synchronisation Frequency* IE when evaluating the timing of the UL synchronisation.]

### Signalling Bearer Re-arrangement:

If the RADIO LINK RECONFIGURATION REQUEST message includes the *Signalling Bearer Request Indicator* IE, the Node B shall allocate a new Communication Control Port for the control of the Node B Communication Context and include the *Target Communication Control Port ID* IE in the RADIO LINK RECONFIGURATION RESPONSE message.

### HS-DSCH Setup:

If the *HS-DSCH Information* IE is present in the RADIO LINK RECONFIGURATION REQUEST message, then:

- The Node B shall setup the requested HS-PDSCH resources on the Serving HS-DSCH Radio Link indicated by the *HS-PDSCH RL ID* IE.
- The Node B shall include the *HARQ Memory Partitioning* IE in the [FDD – *HS-DSCH FDD Information Response* IE] [TDD – *HS-DSCH TDD Information Response* IE] in the RADIO LINK RECONFIGURATION RESPONSE message.
- If the RADIO LINK RECONFIGURATION REQUEST message includes the *MAC-hs Guaranteed Bit Rate* IE for a Priority Queue in the *HS-DSCH MAC-d Flows Information* IE in the *HS-DSCH Information* IE, then the Node B shall use this information to optimise MAC-hs scheduling decisions for the related HSDPA Priority Queue.
- If the RADIO LINK RECONFIGURATION REQUEST message includes the *Discard Timer* IE for a Priority Queue in the *HS-DSCH MAC-d Flows Information* IE in the *HS-DSCH Information* IE, then the Node B shall use this information to discard out-of-date MAC-hs SDUs from the related HSDPA Priority Queue.
- The Node B shall include the *HS-DSCH Initial Capacity Allocation* IE in the [FDD – *HS-DSCH FDD Information Response* IE] [TDD – *HS-DSCH TDD Information Response* IE] in the RADIO LINK RECONFIGURATION RESPONSE message for every HS-DSCH MAC-d flow being established, if the Node B allows the CRNC to start transmission of MAC-d PDUs before the Node B has allocated capacity on user plane as described in [24].
- [FDD - If the RADIO LINK RECONFIGURATION REQUEST message includes the *HS-SCCH Power Offset* IE in the *HS-DSCH Information* IE, then the Node B may use this value to determine the HS-SCCH power. The HS-SCCH Power Offset should be applied for any HS-SCCH transmission to this UE.]
- [FDD - If the RADIO LINK RECONFIGURATION REQUEST message includes the *Measurement Power Offset* IE in the *HS-DSCH Information* IE, then the Node B shall use the measurement power offset as described in ref [10], subclause 6A.2.]
- [FDD - The Node B shall allocate HS-SCCH codes corresponding to the HS-DSCH and include the *HS-SCCH Specific Information Response* IE in the *HS-DSCH FDD Information Response* IE in the RADIO LINK RECONFIGURATION RESPONSE message.]
- [TDD - The Node B shall allocate HS-SCCH parameters corresponding to the HS-DSCH and include the [3.84Mcps TDD - *HS-SCCH Specific Information Response* IE] [1.28Mcps TDD - *HS-SCCH Specific Information Response LCR* IE] in the *HS-DSCH TDD Information Response* IE in the RADIO LINK RECONFIGURATION RESPONSE message.]

- [FDD – If the RADIO LINK RECONFIGURATION REQUEST message includes the *HARQ Preamble Mode* IE in the *HS-DSCH Information* IE, then the Node B shall use the indicated HARQ Preamble Mode as described in [10].]

#### **Intra-Node B Serving HS-DSCH Radio Link Change:**

If the RADIO LINK RECONFIGURATION REQUEST message includes the *HS-PDSCH RL ID* IE, this indicates the new Serving HS-DSCH Radio Link:

- The Node B shall release the HS-PDSCH resources on the old Serving HS-DSCH Radio Link and setup the HS-PDSCH resources on the new Serving HS-DSCH Radio Link.
- The Node B may include the *HARQ Memory Partitioning* IE in the [FDD – *HS-DSCH FDD Information Response* IE] [TDD – *HS-DSCH TDD Information Response* IE] in the RADIO LINK RECONFIGURATION RESPONSE message.
- [FDD – The Node B shall allocate HS-SCCH codes corresponding to the HS-DSCH and include the *HS-SCCH Specific Information Response* IE in the *HS-DSCH FDD Information Response* IE in the RADIO LINK RECONFIGURATION RESPONSE message.]
- [TDD – The Node B shall allocate HS-SCCH parameters corresponding to the HS-DSCH and include the [3.84Mcps TDD – *HS-SCCH Specific Information Response* IE] [1.28Mcps TDD – *HS-SCCH Specific Information Response LCR* IE] in the *HS-DSCH TDD Information Response* IE in the RADIO LINK RECONFIGURATION RESPONSE message.]

#### **HS-DSCH Modification:**

If the RADIO LINK RECONFIGURATION REQUEST message includes the *HS-DSCH Information To ModifyUnsynchronised* IE and if the Serving HS-DSCH Radio Link is in the Node B, then:

- The Node B shall include the *HS-DSCH Initial Capacity Allocation* IE for every HS-DSCH MAC-d flow being modified for which a new transport bearer was requested with the *Transport Bearer Request Indicator* IE, if the Node B allows the CRNC to start transmission of MAC-d PDUs before the Node B has allocated capacity on user plane as described in [32].
- If the RADIO LINK RECONFIGURATION REQUEST message includes the *MAC-hs Guaranteed Bit Rate* IE in the *HS-DSCH Information To ModifyUnsynchronised* IE, the Node B shall use this information to optimise MAC-hs scheduling decisions for the related HSDPA Priority Queue.
- If the RADIO LINK RECONFIGURATION REQUEST message includes the *Discard Timer* IE in the *HS-DSCH Information* IE, then the Node B shall use this information to discard out-of-date MAC-hs SDUs from the related HSDPA Priority Queue.
- [FDD - If the RADIO LINK RECONFIGURATION REQUEST message includes the *ACK Power Offset* IE, the *NACK Power Offset* IE or the *CQI Power Offset* IE in the *HS-DSCH Information To ModifyUnsynchronised* IE, then the Node B shall use the indicated ACK Power Offset, the NACK Power Offset or the CQI Power Offset in the new configuration.]
- [FDD - If the *HS-SCCH Power Offset* IE is included in the *HS-DSCH Information To ModifyUnsynchronised* IE, the Node B may use this value to determine the HS-SCCH power. The HS-SCCH Power Offset should be applied for any HS-SCCH transmission to this UE.]
- [TDD – If the RADIO LINK RECONFIGURATION REQUEST message includes the *TDD ACK NACK Power Offset* IE in the *HS-DSCH Information To ModifyUnsynchronised* IE, the Node B shall use the indicated power offset in the new configuration.]
- [FDD – If the RADIO LINK RECONFIGURATION REQUEST message includes the *HARQ Preamble Mode* IE in the *HS-DSCH Information To ModifyUnsynchronised* IE, then the Node B shall use the indicated HARQ Preamble Mode in the new configuration as described in [10].]

#### **HS-DSCH MAC-d Flow Addition/Deletion:**

If the RADIO LINK RECONFIGURATION REQUEST message includes any *HS-DSCH MAC-d Flows To Add* or *HS-DSCH MAC-d Flows To Delete* IEs and if the Serving HS-DSCH Radio Link is in the Node B, then the Node B shall

use this information to add/delete the indicated HS-DSCH MAC-d flows on the Serving HS-DSCH Radio Link. When an HS-DSCH MAC-d flow is deleted, all its associated Priority Queues shall also be removed.

If the RADIO LINK RECONFIGURATION REQUEST message includes an *HS-DSCH MAC-d Flows To Delete* IE requesting the deletion of all remaining HS-DSCH MAC-d flows for the Node B Communication Context, then the Node B shall delete the HS-DSCH configuration from the Node B Communication Context and release any existing HS-PDSCH resources.

If the RADIO LINK RECONFIGURATION REQUEST message includes the *HS-DSCH MAC-d Flows To Add* IE and if the Serving HS-DSCH Radio Link is in the Node B, then:

- The Node B shall include the *HS-DSCH Initial Capacity Allocation* IE in the RADIO LINK RECONFIGURATION RESPONSE message for every HS-DSCH MAC-d flow being added, if the Node B allows the CRNC to start transmission of MAC-d PDUs before the Node B has allocated capacity on user plane as described in [24].
- If the RADIO LINK RECONFIGURATION REQUEST message includes the *MAC-hs Guaranteed Bit Rate* IE in the *HS-DSCH MAC-d Flows To Add* IE, the Node B shall use this information to optimise MAC-hs scheduling decisions for the related HSDPA Priority Queue.
- If the RADIO LINK RECONFIGURATION REQUEST message includes the *Discard Timer* IE in the *HS-DSCH Information* IE, then the Node B shall use this information to discard out-of-date MAC-hs SDUs from the related HSDPA Priority Queue.

#### **E-DCH Setup:**

If the *E-DCH FDD Information* IE is present in the RADIO LINK RECONFIGURATION REQUEST message:

- The Node B shall setup the requested E-DCH resources on the Radio Links indicated by the *E-DCH RL Indication* IE in the *RL Information* IE.
- If the RADIO LINK RECONFIGURATION REQUEST message includes the *MAC-es Guaranteed Bit Rate* IE in the *E-DCH MAC-d Flows Information* IE, then the Node B shall use this information to optimise MAC-e scheduling decisions.
- If the RADIO LINK RECONFIGURATION REQUEST message includes the *Maximum Number Of Transmissions For E-DCH* IE in the *E-DCH MAC-d Flows Information* IE, then the Node B shall use this information to report if the maximum number of transmissions has elapsed.
- If the *TNL QoS* IE is included for a E-DCH MAC-d flow and if ALCAP is not used, the *TNL QoS* IE may be used by the Node B to determine the transport bearer characteristics to apply in the uplink for the related MAC-d flow.
- The Node B shall include the E-AGCH And E-RGCH/E-HICH FDD Scrambling Code IE, the E-RGCH/E-HICH Channelisation Code IE and the corresponding Sequence Number IEs in the *E-DCH FDD DL Control Channel Information* IE in the RADIO LINK RECONFIGURATION RESPONSE message for every RL indicated by the *E-DCH RL Indication* IE in the *RL Information* IE.
- If the RADIO LINK RECONFIGURATION REQUEST message includes the *Serving E-DCH RL* IE, then the Node B shall allocate an E-RNTI identifier for the corresponding RL and include this E-RNTI identifier and the channelisation code of the corresponding E-AGCH in the *E-DCH FDD DL Control Channel Information* IE in the RADIO LINK RECONFIGURATION RESPONSE message.

#### **Serving E-DCH Radio Link Change:**

If the RADIO LINK RECONFIGURATION REQUEST message includes the *Serving E-DCH RL* IE, this indicates the new Serving E-DCH Radio Link:

- If the old Serving E-DCH RL is in this Node B, the Node B shall de-allocate the E-AGCH resources of the old Serving E-DCH Radio Link.
- If the New Serving E-DCH RL is in this Node B, the Node B shall allocate an E-RNTI identifier for the new Serving E-DCH Radio Link and include this identifier along with the channelisation code of the corresponding E-AGCH in the *E-DCH FDD DL Control Channel Information* IE in the RADIO LINK RECONFIGURATION RESPONSE message.



**E-DCH Modification:**

If the RADIO LINK RECONFIGURATION REQUEST message includes the *E-DCH FDD Information To Modify* IE, then:

- If the RADIO LINK RECONFIGURATION REQUEST message includes the *Data Description Indicator* IE, the Node B shall delete the previous list of DDI values for this Node B Communication Context and use the DDI values indicated in the *Data Description Indicator* IE in the new configuration.

**E-DCH MAC-d Flow Addition/Deletion:**

If the RADIO LINK RECONFIGURATION REQUEST message includes any *E-DCH MAC-d Flows To Add* or *E-DCH MAC-d Flows To Delete* IEs, then the Node B shall use this information to add/delete the indicated E-DCH MAC-d flows. When an E-DCH MAC-d flow is deleted, all its associated configuration data shall also be removed.

If the RADIO LINK RECONFIGURATION REQUEST message includes an *E-DCH MAC-d Flows To Delete* IE requesting the deletion of all remaining E-DCH MAC-d flows for the UE Context, then the Node B shall delete the E-DCH configuration from the Node B Communication Context and release the E-DCH resources.

If the RADIO LINK RECONFIGURATION REQUEST message includes the *E-DCH MAC-d Flows To Add* IE, then:

- If the RADIO LINK RECONFIGURATION REQUEST message includes the *MAC-es Guaranteed Bit Rate* IE in the *E-DCH MAC-d Flows To Add* IE, the Node B shall use this information to optimise MAC-e scheduling decisions.
- If the RADIO LINK RECONFIGURATION REQUEST message includes the *Maximum Number Of Transmissions For E-DCH* IE in the *E-DCH MAC-d Flows To Add* IE, then the Node B shall use this information to report if the maximum number of transmissions has elapsed.

**General**

If the RADIO LINK RECONFIGURATION REQUEST message includes the *Transport Layer Address* IE and *Binding ID* IEs in the *HS-DSCH Information* IE, *HS-DSCH Information To Modify Unsynchronised* IE, *HS-DSCH MAC-d Flows To Add* IE, *E-DCH Information* IE, *E-DCH Information To Modify* IE, *E-DCH MAC-d Flows To Add* IE or in the *RL Specific DCH Information* IE, the Node B may use the transport layer address and the binding identifier received from the CRNC when establishing a transport bearer for any Transport Channel or MAC-d flow being added or any Transport Channel or MAC-d flow being modified for which a new transport bearer was requested with the *Transport Bearer Request Indicator* IE.

If the requested modifications are allowed by the Node B, the Node B has successfully allocated the required resources, and changed to the new configuration, it shall respond to the CRNC with the RADIO LINK RECONFIGURATION RESPONSE message.

The Node B shall include in the RADIO LINK RECONFIGURATION RESPONSE message the *Transport Layer Address* IE and the *Binding ID* IE for any Transport Channel or MAC-d flow being added or any Transport Channel or MAC-d flow being modified for which a new transport bearer was requested with the *Transport Bearer Request Indicator* IE. The detailed frame protocol handling during transport bearer replacement is described in [16], subclause 5.10.1.

In the case of a set of co-ordinated DCHs requiring a new transport bearer on the Iub interface, the *Transport Layer Address* IE and the *Binding ID* IE in the *DCH Information Response* IE shall be included only for one of the DCH in the set of coordinated DCHs.

In the case of a Radio Link being combined with another Radio Link within the Node B, the *Transport Layer Address* IE and the *Binding ID* IE in the *DCH Information Response* IE shall be included only for one of the combined Radio Links.

In the case of a signalling bearer re-arrangement, the new Communication Control Port shall be used once the Node B has sent the RADIO LINK RECONFIGURATION RESPONSE message via the old Communication Control Port.

### 8.3.5.3 Unsuccessful Operation

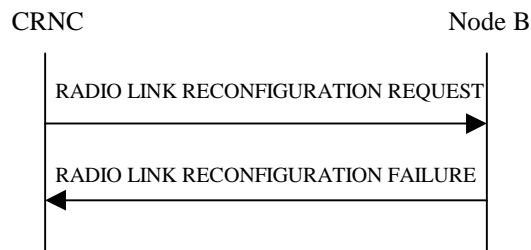

**Figure 35: Unsynchronised Radio Link Reconfiguration procedure, Unsuccessful Operation**

If the Node B cannot allocate the necessary resources for all the new DCHs of one set of co-ordinated DCHs requested to be set-up, it shall regard the Unsynchronised Radio Link Reconfiguration procedure as having failed.

If the requested Unsynchronised Radio Link Reconfiguration procedure fails for one or more Radio Link(s), the Node B shall send the RADIO LINK RECONFIGURATION FAILURE message to the CRNC, indicating the reason for failure.

Typical cause values are as follows:

#### Radio Network Layer Cause

- CM not supported
- HARQ Preamble Mode not supported

#### Transport Layer Cause

- Transport Resources Unavailable

#### Miscellaneous Cause

- O&M Intervention
- Control processing overload
- HW failure

### 8.3.5.4 Abnormal Conditions

If only a subset of all the DCHs belonging to a set of co-ordinated DCHs is requested to be deleted, the Node B shall regard the Unsynchronised Radio Link Reconfiguration procedure as having failed and shall send the RADIO LINK RECONFIGURATION FAILURE message to the CRNC.

[FDD – If [the concerned Node B Communication Context is configured to use DPCH in the downlink and if](#) the *RL Information* IE contains the *DL Code Information* IE and this IE includes *DL Scrambling Code* and *FDD DL Channelisation Code Number* IEs not matching the DL Channelisation code(s) already allocated to the Radio Link identified by *RL ID* IE, then the Node B shall consider the Unsynchronised Radio Link Reconfiguration procedure as having failed and it shall send the RADIO LINK RECONFIGURATION FAILURE message to the CRNC.]

If more than one DCH of a set of co-ordinated DCHs has the *QE-Selector* IE set to "selected" [TDD – or no DCH of a set of co-ordinated DCHs has the *QE-Selector* IE set to "selected"], the Node B shall regard the Unsynchronised Radio Link Reconfiguration Preparation procedure as failed and shall respond with a RADIO LINK RECONFIGURATION FAILURE message.

If the RADIO LINK RECONFIGURATION REQUEST message includes a *DCHs To Modify* IE or *DCHs To Add* IE with multiple *DCH Specific Info* IEs, and if the DCHs in the *DCHs To Modify* IE or *DCHs To Add* IE do not have the same *Transmission Time Interval* IE in the *Semi-Static Transport Format Information* IE, then the Node B shall reject the procedure using the RADIO LINK RECONFIGURATION FAILURE message.

[FDD - If the *RL Information* IE includes the *DL Reference Power* IEs, but the power balancing is not active in the indicated RL(s), the Node B shall regard the Unsynchronised Radio Link Reconfiguration procedure as having failed

and the Node B shall respond the RADIO LINK RECONFIGURATION FAILURE message with the cause value "Power Balancing status not compatible".]

[FDD - If the power balancing is active with the Power Balancing Adjustment Type of the Node B Communication Context set to "Common" in the existing RL(s) but the *RL Information* IE includes more than one *DL Reference Power* IEs, the Node B shall regard the Unsynchronised Radio Link Reconfiguration procedure as having failed and the Node B shall respond the RADIO LINK RECONFIGURATION FAILURE message with the cause value "Power Balancing status not compatible".]

[FDD – If the RADIO LINK RECONFIGURATION REQUEST message includes the *Length Of TFCI2* IE but the *TFCI Signalling Option* IE is set to "Normal", then the Node B shall reject the procedure using the RADIO LINK RECONFIGURATION FAILURE message.]

[FDD – If the RADIO LINK RECONFIGURATION REQUEST message does not include the *Length Of TFCI2* IE but the *Split Type* IE is set to "Logical", then the Node B shall reject the procedure using the RADIO LINK RECONFIGURATION FAILURE message.]

[FDD – If the RADIO LINK RECONFIGURATION REQUEST message includes the *Split Type* IE set to the value "Hard" and the *Length Of TFCI2* IE set to the value "1", "2", "5", "8", "9" or "10", then the Node B shall reject the procedure using the RADIO LINK RECONFIGURATION FAILURE message.]

If the RADIO LINK RECONFIGURATION REQUEST message contains the *Transport Layer Address* IE or the *Binding ID* IE when establishing a transport bearer for any Transport Channel or HS-DSCH MAC-d flow being added or any Transport Channel or HS-DSCH MAC-d flow being modified for which a new transport bearer was requested with the *Transport Bearer Request Indicator* IE, and not both are present for a transport bearer intended to be established, the Node B shall reject the procedure using the RADIO LINK RECONFIGURATION FAILURE message.

If the RADIO LINK RECONFIGURATION REQUEST message contains any of the *HS-DSCH Information To Modify* IE, *HS-DSCH MAC-d Flows To Add* IE or *HS-DSCH MAC-d Flows To Delete* IE in addition to the *HS-DSCH Information* IE, the Node B shall reject the procedure using the RADIO LINK RECONFIGURATION FAILURE message.

If the RADIO LINK RECONFIGURATION REQUEST message contains any of the *HS-DSCH Information To Modify* IE, *HS-DSCH MAC-d Flows To Add* IE, *HS-DSCH MAC-d Flows To Delete* IE or *HS-PDSCH RL ID* IE and the Serving HS-DSCH Radio Link is not in the Node B, the Node B shall reject the procedure using the RADIO LINK RECONFIGURATION FAILURE message.

If the RADIO LINK RECONFIGURATION REQUEST message includes the *HS-DSCH Information* IE and does not include the *HS-PDSCH RL-ID* IE, the Node B shall reject the procedure using the RADIO LINK RECONFIGURATION FAILURE message.

If the RADIO LINK RECONFIGURATION REQUEST message includes the *HS-PDSCH RL-ID* IE indicating a Radio Link not existing in the Node B Communication Context, the Node B shall reject the procedure using the RADIO LINK RECONFIGURATION FAILURE message.

If the RADIO LINK RECONFIGURATION REQUEST message contains any of the *HS-DSCH Information* IE, *HS-DSCH Information To Modify* IE, or *HS-DSCH MAC-d Flows To Add* IE and if in the new configuration the Priority Queues associated with the same *HS-DSCH MAC-d Flow ID* IE have the same *Scheduling Priority Indicator* IE value, the Node B shall reject the procedure using the RADIO LINK RECONFIGURATION FAILURE message.

[FDD – If the concerned Node B Communication Context is configured to use F-DPCH in the downlink and if the *RL Information* IE contains the *DL Code Information* IE, then the Node B shall consider the Unsynchronised Radio Link Reconfiguration procedure as having failed and it shall send the RADIO LINK RECONFIGURATION FAILURE message to the CRNC.]

## 8.3.14 Compressed Mode Command [FDD]

### 8.3.14.1 General

The Compressed Mode Command procedure is used to activate or deactivate the compressed mode in the Node B for one Node B Communication Context.

The Compressed Mode Command procedure shall not be initiated if a Prepared Reconfiguration exists, as defined in subclause 3.1.

### 8.3.14.2 Successful Operation



**Figure 47: Compressed Mode Command procedure, Successful Operation**

The procedure is initiated by the CRNC sending a COMPRESSED MODE COMMAND message to the Node B using the Communication Control Port assigned to the concerned Node B Communication Context.

The Node B shall deactivate all the ongoing Transmission Gap Pattern Sequences at the *CM Configuration Change CFN* IE requested by the CRNC when receiving the COMPRESSED MODE COMMAND message from the CRNC. From that moment on, all Transmission Gap Pattern Sequences included in *Transmission Gap Pattern Sequence Status* IE repetitions (if present) shall be started when the indicated *TGCFN* IE elapses. The *CM Configuration Change CFN* IE in the *Active Pattern Sequence Information* IE and *TGCFN* IE for each sequence refer to the next coming CFN with that value.

If the values of the *CM Configuration Change CFN* IE and the *TGCFN* IE are equal, the concerned Transmission Gap Pattern Sequence shall be started immediately at the CFN with a value equal to the value received in the *CM Configuration Change CFN* IE.

If the concerned Node B Communication Context is configured to use F-DPCH in the downlink, the Node B shall ignore, when activating the Transmission Gap Pattern Sequence(s), the downlink compressed mode method information, if existing, for the concerned Transmission Gap Pattern Sequence(s) in the Compressed Mode Configuration.

### 8.3.14.3 Abnormal Conditions

-

## 8.3.18 Radio Link Activation

### 8.3.18.1 General

This procedure is used to activate or de-activate the DL transmission on the Uu interface regarding selected RLs.

### 8.3.18.2 Successful Operation



**Figure 47D: Radio Link Activation procedure**

This procedure is initiated by sending the RADIO LINK ACTIVATION COMMAND message from the CRNC to the Node B. The message shall use the Communication Control Port assigned for this Node B Communication Context. Upon reception, the Node B shall for each concerned RL:

- if the *Delayed Activation Update* IE indicates "Activate":
  - if the *Activation Type* IE equals "Unsynchronised":
    - [FDD - start transmission on the new RL after synchronisation is achieved in the DL user plane as specified in [16].]
    - [TDD - start transmission on the new RL immediately as specified in [16].]
  - if the *Activation Type* IE equals "Synchronised":
    - [FDD - start transmission on the new RL after synchronisation is achieved in the DL user plane as specified in [16], however never before the CFN indicated in the *Activation CFN* IE.]
    - [TDD - start transmission on the new RL at the CFN indicated in the *Activation CFN* IE as specified in [16].]
- [FDD - the Node B shall apply the power level indicated in the *Initial DL Tx Power* IE to the transmission on each DL DPCH [or on the F-DPCH](#) of the RL when starting transmission until either UL synchronisation on the Uu interface is achieved for the RLS or power balancing is activated. During this period no inner loop power control shall be performed and, unless activated by the DL POWER CONTROL REQUEST message, no power balancing shall be performed. The DL power shall then vary according to the inner loop power control (see ref.[10], subclause 5.2.1.2) and downlink power balancing adjustments (see subclause 8.3.7).]
- [TDD - the Node B shall apply the power level indicated in the *Initial DL Tx Power* IE to the transmission on each DL DPCH and on each Time Slot of the RL when starting transmission until the UL synchronisation on the Uu interface is achieved for the RL. No inner loop power control shall be performed during this period. The DL power shall then vary according to the inner loop power control (see ref.[22], subclause 4.2.3.3).]
- [FDD - if the *Propagation Delay* IE is included, the Node B may use this information to speed up the detection of UL synchronisation on the Uu interface.]
- [FDD - if the *First RLS Indicator* IE is included, it indicates if the concerned RL shall be considered part of the first RLS established towards this UE. The *First RLS Indicator* IE shall be used by the Node B together with the value of the *DL TPC Pattern 01 Count* IE which the Node B has received in the Cell Setup procedure, to determine the initial TPC pattern in the DL of the concerned RL and all RLs which are part of the same RLS, as described in [10], section 5.1.2.2.1.2.]
- if the *Delayed Activation Update* IE indicates "Deactivate":

- stop DL transmission immediately, if the *Deactivation Type* IE equals "Unsynchronised", or at the CFN indicated by the *Deactivation CFN* IE, if the *Deactivation Type* IE equals "Synchronised".

### 8.3.18.3 Abnormal Conditions

[FDD- If the *Delayed Activation Update* IE is included in the RADIO LINK ACTIVATION COMMAND message, it indicates "Activate" and the *First RLS Indicator* IE is not included, the Node B shall initiate the Error Indication procedure.]

## 9.1.36 RADIO LINK SETUP REQUEST

## 9.1.36.1 FDD message

IE/Group Name	Presence	Range	IE Type and Reference	Semantics Description	Criticality	Assigned Criticality
Message Discriminator	M		9.2.1.45		–	
Message Type	M		9.2.1.46		YES	reject
Transaction ID	M		9.2.1.62		–	
CRNC Communication Context ID	M		9.2.1.18	The reserved value "All CRNCCC" shall not be used.	YES	reject
<b>UL DPCH Information</b>		1			YES	reject
>UL Scrambling Code	M		9.2.2.59		–	
>Min UL Channelisation Code Length	M		9.2.2.22		–	
>Max Number of UL DPDCHs	C-CodeLen		9.2.2.21		–	
>Puncture Limit	M		9.2.1.50	For UL	–	
>TFCS	M		9.2.1.58	For UL	–	
>UL DPCCH Slot Format	M		9.2.2.57		–	
>UL SIR Target	M		UL SIR 9.2.1.67A		–	
>Diversity Mode	M		9.2.2.9		–	
>SSDT Cell ID Length	O		9.2.2.45		–	
>S Field Length	O		9.2.2.40		–	
>DPC Mode	O		9.2.2.13C		YES	reject
>UL DPDCH Indicator For E-DCH Operation	C-ifEDPCHInfo		ENUMERATED (UL-DPDCH present, UL-DPDCH not present)		YES	reject
<b>E-DPCH Information</b>		0..1			YES	reject
>Min UL Channelisation Code Length For E-DCH FDD	M		9.2.2.22a		–	
>Max Number Of UL E-DPDCHs	C-CodeLenE DCH		9.2.2.20B	more than one E-DPDCHs possible in case of SF=[2 or 4]	–	
>Puncture Limit	M		9.2.1.50		–	
>E-TFCS	M		9.2.1.29ag		–	
>E-TTI	M		ENUMERATED (2ms, 10ms)		–	
<b>DL DPCH Information</b>		0..1			YES	reject
>TFCS	M		9.2.1.58	For DL	–	
>DL DPCH Slot Format	M		9.2.2.10		–	
>TFCI Signalling Mode	M		9.2.2.50		–	
>TFCI Presence	C-SlotFormat		9.2.1.57		–	
>Multiplexing Position	M		9.2.2.23		–	
>PDSCH RL ID	C-DSCH		RL ID 9.2.1.53		–	
>PDSCH Code Mapping	C-DSCH		9.2.2.25		–	
<b>&gt;Power Offset Information</b>		1			–	

>>PO1	M		Power Offset 9.2.2.29	Power offset for the TFCI bits	–	
>>PO2	M		Power Offset 9.2.2.29	Power offset for the TPC bits	–	
>>PO3	M		Power Offset 9.2.2.29	Power offset for the pilot bits	–	
>FDD TPC DL Step Size	M		9.2.2.16		–	
>Limited Power Increase	M		9.2.2.18A		–	
>Inner Loop DL PC Status	M		9.2.2.18B		–	
DCH Information	M		DCH FDD Information 9.2.2.4D		YES	reject
DSCH Information	O		DSCH FDD Information 9.2.2.13B		YES	reject
<b>TFCI2 Bearer Information</b>		<i>0..1</i>			YES	ignore
>ToAWS	M		9.2.1.61		–	
>ToAWE	M		9.2.1.60		–	
>Binding ID	O		9.2.1.4	Shall be ignored if bearer establishment with ALCAP.	YES	ignore
>Transport Layer Address	O		9.2.1.63	Shall be ignored if bearer establishment with ALCAP.	YES	ignore
<b>RL Information</b>		<i>1..&lt;maxno ofRLs&gt;</i>			EACH	notify
>RL ID	M		9.2.1.53		–	
>C-ID	M		9.2.1.9		–	
>First RLS Indicator	M		9.2.2.16A		–	
>Frame Offset	M		9.2.1.31		–	
>Chip Offset	M		9.2.2.2		–	
>Propagation Delay	O		9.2.2.35		–	
>Diversity Control Field	C-NotFirstRL		9.2.1.25		–	
>DL Code Information	M		FDD DL Code Information 9.2.2.14A		–	
>Initial DL Transmission Power	M		DL Power 9.2.1.21	Initial power on DPCH <a href="#">or on F-DPCH</a>	–	
>Maximum DL Power	M		DL Power 9.2.1.21	Maximum allowed power on DPCH <a href="#">or on F-DPCH</a>	–	
>Minimum DL Power	M		DL Power 9.2.1.21	Minimum allowed power on DPCH <a href="#">or on F-DPCH</a>	–	
>SSDT Cell Identity	O		9.2.2.44		–	
>Transmit Diversity Indicator	C-Diversity mode		9.2.2.53		–	
>SSDT Cell Identity For EDSCHPC	C-EDSCHPC		9.2.2.44A		YES	ignore
>RL Specific DCH Information	O		9.2.1.53G		YES	ignore
>Delayed Activation	O		9.2.1.24C		YES	reject



>Qth Parameter	O		9.2.2.36A		YES	ignore
>Primary CPICH Usage For Channel Estimation	O		9.2.2.33A		YES	ignore
>Secondary CPICH Information	O		Common Physical Channel ID 9.2.1.13		YES	ignore
>E-DCH RL Indication	O		9.2.2.13De		YES	reject
Transmission Gap Pattern Sequence Information	O		9.2.2.53A		YES	reject
Active Pattern Sequence Information	O		9.2.2.A		YES	reject
DSCH Common Information	O		DSCH FDD Common Information 9.2.2.13D		YES	ignore
DL Power Balancing Information	O		9.2.2.12B		YES	ignore
HS-DSCH Information	O		HS-DSCH FDD Information 9.2.2.18D		YES	reject
HS-DSCH-RNTI	C-InfoHSDSCH		9.2.1.31J		YES	reject
HS-PDSCH RL ID	C-InfoHSDSCH		RL ID 9.2.1.53		YES	reject
E-DCH FDD Information	C-EDPCHInfo		9.2.2.13Da		YES	reject
Serving E-DCH RL	C-EDPCHInfo		9.2.1.53Ha		YES	reject
<b>F-DPCH Information</b>		<u>0..1</u>			<u>YES</u>	<u>reject</u>
<b>&gt;Power Offset Information</b>		<u>1</u>			<u>=</u>	
<b>&gt;&gt;PO2</b>	<u>M</u>		<u>Power Offset 9.2.2.29</u>	<u>Power offset for the TPC bits</u>	<u>-</u>	
<b>&gt;FDD TPC DL Step Size</b>	<u>M</u>		<u>9.2.2.16</u>		<u>=</u>	
<b>&gt;Limited Power Increase</b>	<u>M</u>		<u>9.2.2.18A</u>		<u>=</u>	
<b>&gt;Inner Loop DL PC Status</b>	<u>M</u>		<u>9.2.2.18B</u>		<u>=</u>	

Condition	Explanation
CodeLen	The IE shall be present if <i>Min UL Channelisation Code Length</i> IE equals to 4.
NotFirstRL	The IE shall be present if the RL is not the first one in the <i>RL Information</i> IE.
DSCH	The IE shall be present if the <i>DSCH Information</i> IE is present.
SlotFormat	The IE shall be present if the <i>DL DPCH Slot Format</i> IE is equal to any of the values from 12 to 16.
Diversity mode	The IE shall be present if <i>Diversity Mode</i> IE in <i>UL DPCH Information</i> IE is not set to "none".
EDSCHPC	The IE shall be present if <i>Enhanced DSCH PC</i> IE is present in the <i>DSCH Common Information</i> IE.
InfoHSDSCH	The IE shall be present if <i>HS-DSCH Information</i> IE is present.
EDPCHInfo	This IE shall be present if <i>E-DPCH Information</i> IE is present.
CodeLenEDCH	The IE shall be present if <i>Min UL Channelisation Code Length For E-DCH FDD</i> IE equals [2 or 4]

Range Bound	Explanation
<i>maxnoofRLs</i>	Maximum number of RLs for one UE

## 9.1.39 RADIO LINK ADDITION REQUEST

## 9.1.39.1 FDD Message

IE/Group Name	Presence	Range	IE Type and Reference	Semantics Description	Criticality	Assigned Criticality
Message Discriminator	M		9.2.1.45		–	
Message Type	M		9.2.1.46		YES	reject
Transaction ID	M		9.2.1.62		–	
Node B Communication Context ID	M		9.2.1.48	The reserved value "All NBCC" shall not be used.	YES	reject
Compressed Mode Deactivation Flag	O		9.2.2.3A		YES	reject
<b>RL Information</b>		<i>1..&lt;maxno ofRLs-1&gt;</i>			EACH	notify
>RL ID	M		9.2.1.53		–	
>C-ID	M		9.2.1.9		–	
>Frame Offset	M		9.2.1.31		–	
>Chip Offset	M		9.2.2.2		–	
>Diversity Control Field	M		9.2.1.25		–	
>DL Code Information	M		FDD DL Code Information 9.2.2.14A		–	
>Initial DL Transmission Power	O		DL Power 9.2.1.21	Initial power on DPCH <a href="#">or on F-DPCH</a>	–	
>Maximum DL Power	O		DL Power 9.2.1.21	Maximum allowed power on DPCH <a href="#">or on F-DPCH</a>	–	
>Minimum DL Power	O		DL Power 9.2.1.21	Minimum allowed power on DPCH <a href="#">or on F-DPCH</a>	–	
>SSDT Cell Identity	O		9.2.2.44		–	
>Transmit Diversity Indicator	O		9.2.2.53		–	
>DL Reference Power	O		DL power 9.2.1.21	Power on DPCH <a href="#">or on F-DPCH</a>	YES	ignore
>RL Specific DCH Information	O		9.2.1.53G		YES	ignore
>E-DCH RL Indication	O		9.2.2.13De		YES	reject
>Delayed Activation	O		9.2.1.24C		YES	reject
>Qth Parameter	O		9.2.2.36A		YES	ignore
>Primary CPICH Usage For Channel Estimation	O		9.2.2.33A		YES	ignore

Range Bound	Explanation
<i>maxnoofRLs</i>	Maximum number of RLs for one UE

## 9.1.42 RADIO LINK RECONFIGURATION PREPARE

## 9.1.42.1 FDD Message

IE/Group Name	Presence	Range	IE Type and Reference	Semantics Description	Criticality	Assigned Criticality
Message Discriminator	M		9.2.1.45		–	
Message Type	M		9.2.1.46		YES	reject
Transaction ID	M		9.2.1.62		–	
Node B Communication Context ID	M		9.2.1.48	The reserved value "All NBCC" shall not be used.	YES	reject
<b>UL DPCH Information</b>		<i>0..1</i>			YES	reject
>UL Scrambling Code	O		9.2.2.59		–	
>UL SIR Target	O		UL SIR 9.2.1.67A		–	
>Min UL Channelisation Code Length	O		9.2.2.22		–	
>Max Number of UL DPDCHs	C-CodeLen		9.2.2.21		–	
>Puncture Limit	O		9.2.1.50	For UL	–	
>TFCS	O		9.2.1.58		–	
>UL DPCCH Slot Format	O		9.2.2.57		–	
>Diversity Mode	O		9.2.2.9		–	
>SSDT Cell Identity Length	O		9.2.2.45		–	
>S-Field Length	O		9.2.2.40		–	
>UL DPDCH Indicator For E-DCH Operation	C-ifEDPCHInfo		ENUMERATED (UL-DPDCH present, UL-DPDCH not present)		YES	reject
<b>DL DPCH Information</b>		<i>0..1</i>			YES	reject
>TFCS	O		9.2.1.58		–	
>DL DPCH Slot Format	O		9.2.2.10		–	
>TFCI Signalling Mode	O		9.2.2.50		–	
>TFCI Presence	C-SlotFormat		9.2.1.57		–	
>Multiplexing Position	O		9.2.2.23		–	
>PDSCH Code Mapping	O		9.2.2.25		–	
>PDSCH RL ID	O		RL ID 9.2.1.53		–	
>Limited Power Increase	O		9.2.2.18A		–	
<b>&gt;DL DPCH Power Information</b>		<i>0..1</i>			<u>YES</u>	<u>reject</u>
<b>&gt;&gt;Power Offset Information</b>		<i>1</i>			=	
>>>PO1	<u>M</u>		<u>Power Offset</u> <u>9.2.2.29</u>	<u>Power offset for the TFCI bits</u>	=	
>>>PO2	<u>M</u>		<u>Power Offset</u> <u>9.2.2.29</u>	<u>Power offset for the TPC bits</u>	=	
>>>PO3	<u>M</u>		<u>Power Offset</u> <u>9.2.2.29</u>	<u>Power offset for the pilot bits</u>	–	
>>FDD TPC DL Step Size	<u>M</u>		<u>9.2.2.16</u>		=	
>>Inner Loop DL PC Status	<u>M</u>		<u>9.2.2.18B</u>		=	

<b>E-DPCH Information</b>		0..1			YES	reject
>Min UL Channelisation Code Length For E-DCH FDD	O		9.2.2.22a		–	
>Max Number Of UL E-DPDCHs	C-CodeLenE DCH		9.2.2.20B	more than one E-DPDCHs possible in case of SF=[2 or 4]	–	
>Puncture Limit	O		9.2.1.50		–	
>E-TFCS	O		9.2.1.29ag		–	
>E-TTI	O		ENUMERATED (2ms, 10ms)		–	
DCHs To Modify	O		DCHs FDD To Modify 9.2.2.4E		YES	reject
DCHs To Add	O		DCH FDD Information 9.2.2.4D		YES	reject
<b>DCHs To Delete</b>		0..<maxno ofDCHs>			GLOBAL	reject
>DCH ID	M		9.2.1.20		–	
<b>DSCH To Modify</b>		0..<maxno ofDSCHs>			EACH	reject
>DSCH ID	M		9.2.1.27		–	
>Transport Format Set	O		9.2.1.59	For the DL.	–	
>Allocation/Retention Priority	O		9.2.1.1A		–	
>Frame Handling Priority	O		9.2.1.30		–	
>ToAWS	O		9.2.1.61		–	
>ToAWE	O		9.2.1.60		–	
>Transport Bearer Request Indicator	M		9.2.1.62A		–	
>Binding ID	O		9.2.1.4	Shall be ignored if bearer establishment with ALCAP.	YES	ignore
>Transport Layer Address	O		9.2.1.63	Shall be ignored if bearer establishment with ALCAP.	YES	ignore
DSCH To Add	O		DSCH FDD Information 9.2.2.13B		YES	reject
<b>DSCH To Delete</b>		0..<maxno ofDSCHs>			EACH	reject
>DSCH ID	M		9.2.1.27		–	
<b>TFCI2 Bearer Information</b>		0..1			YES	reject
>CHOICE TFCI2 Bearer Action	M				–	
>>Add or modify					–	
>>>ToAWS	M		9.2.1.61		–	
>>>ToAWE	M		9.2.1.60		–	
>>>TFCI2 Bearer Request Indicator	O		9.2.1.56C		YES	reject
>>>Binding ID	O		9.2.1.4	Shall be ignored if bearer establishment with ALCAP.	YES	ignore
>>>Transport Layer	O		9.2.1.63	Shall be	YES	ignore

Address				ignored if bearer establishment with ALCAP.		
>>Delete			NULL		-	
<b>RL Information</b>		<i>0..&lt;maxno ofRLs&gt;</i>			EACH	reject
>RL ID	M		9.2.1.53		-	
>DL Code Information	O		FDD DL Code Information 9.2.2.14A		-	
>Maximum DL Power	O		DL Power 9.2.1.21	Maximum allowed power on DPCH <a href="#">or on F-DPCH</a>	-	
>Minimum DL Power	O		DL Power 9.2.1.21	Minimum allowed power on DPCH <a href="#">or on F-DPCH</a>	-	
>SSDT Indication	O		9.2.2.47		-	
>SSDT Cell Identity	C-SSDTIndON		9.2.2.44		-	
>Transmit Diversity Indicator	C-Diversity mode		9.2.2.53		-	
>SSDT Cell Identity For EDSCHPC	C-EDSCHPC		9.2.2.44A		YES	ignore
>DL Reference Power	O		DL Power 9.2.1.21	Power on DPCH <a href="#">or on F-DPCH</a>	YES	ignore
>RL Specific DCH Information	O		9.2.1.53G		YES	ignore
>DL DPCH Timing Adjustment	O		9.2.2.10A	Required RL Timing Adjustment	YES	reject
>Qth Parameter	O		9.2.2.36A		YES	ignore
>Primary CPICH Usage For Channel Estimation	O		9.2.2.33A		YES	ignore
>Secondary CPICH Information Change	O		9.2.2.43A		YES	ignore
>E-DCH RL Indication	O		9.2.2.13De		YES	reject
Transmission Gap Pattern Sequence Information	O		9.2.2.53A		YES	reject
DSCH Common Information	O		DSCH FDD Common Information 9.2.2.13D		YES	ignore
Signalling Bearer Request Indicator	O		9.2.1.55A		YES	reject
HS-DSCH Information	O		HS-DSCH FDD Information 9.2.2.18D		YES	reject
HS-DSCH Information To Modify	O		9.2.1.31H		YES	reject
HS-DSCH MAC-d Flows To Add	O		HS-DSCH MAC-d Flows Information 9.2.1.31IA		YES	reject
HS-DSCH MAC-d Flows To	O		9.2.1.31IB		YES	reject

Delete						
HS-DSCH-RNTI	C-HSDSCH RadioLink		9.2.1.31J		YES	reject
HS-PDSCH RL ID	O		RL ID 9.2.1.53		YES	reject
E-DCH FDD Information	O		E-DCH FDD Information 9.2.2.13Da		YES	reject
E-DCH FDD Information To Modify	O		9.2.2.13Df		YES	reject
E-DCH MAC-d Flows To Add	O		E-DCH MAC-d Flows Information 9.2.2.29ab		YES	reject
E-DCH MAC-d Flows To Delete	O		9.2.1.29ac		YES	reject
Serving E-DCH RL	O		9.2.1.53Ha		YES	reject
<a href="#">F-DPCH Information</a>		<a href="#">0..1</a>			<a href="#">YES</a>	<a href="#">reject</a>
<a href="#">&gt;Power Offset Information</a>		<a href="#">1</a>			=	
<a href="#">&gt;&gt;PO2</a>	<a href="#">M</a>		<a href="#">Power Offset 9.2.2.29</a>	<a href="#">Power offset for the TPC bits</a>	-	
<a href="#">&gt;FDD TPC DL Step Size</a>	<a href="#">M</a>		<a href="#">9.2.2.16</a>		=	
<a href="#">&gt;Limited Power Increase</a>	<a href="#">M</a>		<a href="#">9.2.2.18A</a>		=	
<a href="#">&gt;Inner Loop DL PC Status</a>	<a href="#">M</a>		<a href="#">9.2.2.18B</a>		=	

Condition	Explanation
SSDTIndON	The IE shall be present if the <i>SSDT Indication</i> IE is set to "SSDT Active in the UE".
CodeLen	The IE shall be present if the <i>Min UL Channelisation Code Length</i> IE is equals to 4.
SlotFormat	The IE shall be present if the <i>DL DPCH Slot Format</i> IE is equal to any of the values from 12 to 16.
Diversity mode	The IE shall be present if the <i>Diversity Mode</i> IE is present in the <i>UL DPCH Information</i> IE and is not set to "none".
EDSCHPC	The IE shall be present if the <i>Enhanced DSCH PC</i> IE is present in the <i>DSCH Common Information</i> IE.
HSDSCHRadio Link	The IE shall be present if <i>HS-PDSCH RL ID</i> IE is present.
EDPCHInfo	This IE shall be present if <i>E-DPCH Information</i> IE is present.
CodeLenEDCH	The IE shall be present if <i>Min UL Channelisation Code Length For E-DCH FDD</i> IE equals [2 or 4]

Range Bound	Explanation
<i>maxnoofDCHs</i>	Maximum number of DCHs for a UE
<i>maxnoofDSCHs</i>	Maximum number of DSCHs for a UE
<i>maxnoofRLs</i>	Maximum number of RLs for a UE

## 9.1.47 RADIO LINK RECONFIGURATION REQUEST

## 9.1.47.1 FDD Message

IE/Group Name	Presence	Range	IE Type and Reference	Semantics Description	Criticality	Assigned Criticality
Message Discriminator	M		9.2.1.45		–	
Message Type	M		9.2.1.46		YES	reject
Transaction ID	M		9.2.1.62		–	
Node B Communication Context ID	M		9.2.1.48	The reserved value "All NBCC" shall not be used.	YES	reject
<b>UL DPCH Information</b>		<i>0..1</i>			YES	reject
>TFCS	O		9.2.1.58	For the UL.	–	
>UL DPDCH Indicator For E-DCH Operation	C-ifEDPCHInfo		ENUMERATED (UL-DPDCH present, UL-DPDCH not present)		YES	reject
<b>E-DPCH Information</b>		<i>0..1</i>			YES	reject
>E-TFCS	O		9.2.1.29ag		–	
<b>DL DPCH Information</b>		<i>0..1</i>			YES	reject
>TFCS	O		9.2.1.58	For the DL.	–	
>TFCI Signalling Mode	O		9.2.2.50		–	
>Limited Power Increase	O		9.2.2.18A		–	
DCHs To Modify	O		DCHs FDD To Modify 9.2.2.4E		YES	reject
DCHs To Add	O		DCH FDD Information 9.2.2.4D		YES	reject
<b>DCHs To Delete</b>		<i>0..&lt;maxno ofDCHs&gt;</i>			GLOBAL	reject
>DCH ID	M		9.2.1.20		–	
<b>Radio Link Information</b>		<i>0..&lt;maxno ofRLs&gt;</i>			EACH	reject
>RL ID	M		9.2.1.53		–	
>Maximum DL Power	O		DL Power 9.2.1.21	Maximum allowed power on DPCH <a href="#">or on F-DPCH</a>	–	
>Minimum DL Power	O		DL Power 9.2.1.21	Minimum allowed power on DPCH <a href="#">or on F-DPCH</a>	–	
>DL Code Information	C-SF/2		FDD DL Code Information 9.2.2.14A		–	
>DL Reference Power	O		DL Power 9.2.1.21	Power on DPCH <a href="#">or on F-DPCH</a>	YES	ignore
>RL Specific DCH Information	O		9.2.1.53G		YES	ignore
>E-DCH RL Indication	O		9.2.2.13De		YES	reject
Transmission Gap Pattern Sequence Information	O		9.2.2.53A		YES	reject
Signalling Bearer Request Indicator	O		9.2.1.55A		YES	reject



HS-DSCH Information	O		HS-DSCH FDD Information 9.2.2.18D		YES	reject
HS-DSCH Information To Modify Unsynchronised	O		9.2.1.31HA		YES	reject
HS-DSCH MAC-d Flows To Add	O		HS-DSCH MAC-d Flows Information 9.2.1.31IA		YES	reject
HS-DSCH MAC-d Flows To Delete	O		9.2.1.31IB		YES	reject
HS-DSCH-RNTI	C-HSDSCH RadioLink		9.2.1.31J		YES	reject
HS-PDSCH RL ID	O		RL ID 9.2.1.53		YES	reject
E-DCH FDD Information	O		E-DCH FDD Information 9.2.2.13Da		YES	reject
E-DCH FDD Information To Modify	O		9.2.2.13Df		YES	reject
E-DCH MAC-d Flows To Add	O		E-DCH FDD MAC-d Flows Information 9.2.2.29ab		YES	reject
E-DCH MAC-d Flows To Delete	O		9.2.1.29ac		YES	reject
Serving E-DCH RL	O		9.2.1.53Ha		YES	reject

Range Bound	Explanation
<i>maxnoofDCHs</i>	Maximum number of DCHs for a UE
<i>maxnoofRLs</i>	Maximum number of RLs for a UE
<i>maxnoofMACdFlows</i>	Maximum number of MAC-d Flows
EDPCHInfo	This IE shall be present if <i>E-DPCH Information</i> IE is present.

Condition	Explanation
SF/2	The IE shall be present if the <i>Transmission Gap Pattern Sequence Information</i> IE is included and the indicated Downlink Compressed Mode method for at least one of the included Transmission Gap Pattern Sequence is set to "SF/2".
HSDSCHRadio Link	The IE shall be present if <i>HS-PDSCH RL ID</i> IE is present.

## 9.1.51 DL POWER CONTROL REQUEST [FDD]

IE/Group Name	Presence	Range	IE Type and Reference	Semantics Description	Criticality	Assigned Criticality
Message Discriminator	M		9.2.1.45		–	
Message Type	M		9.2.1.46		YES	ignore
Transaction ID	M		9.2.1.62		–	
Node B Communication Context ID	M		9.2.1.48	The reserved value "All NBCC" shall not be used.	YES	ignore
Power Adjustment Type	M		9.2.2.27		YES	ignore
DL Reference Power	C-Common		DL power 9.2.1.21	Power on DPCH <a href="#">or on F-DPCH</a>	YES	ignore
Inner Loop DL PC Status	O		9.2.2.18B		YES	ignore
<b>DL Reference Power Information</b>	C-Individual	1..<maxno ofRLs>			EACH	ignore
>RL ID	M		9.2.1.53		–	
>DL Reference Power	M		DL power 9.2.1.21	Power on DPCH <a href="#">or on F-DPCH</a>	–	
Max Adjustment Step	C-CommonOrIndividual		9.2.2.20		YES	ignore
Adjustment Period	C-CommonOrIndividual		9.2.2.B		YES	ignore
Adjustment Ratio	C-CommonOrIndividual		9.2.2.C		YES	ignore

Condition	Explanation
Common	The IE shall be present if the <i>Adjustment Type</i> IE is equal to "Common".
Individual	The IE shall be present if the <i>Adjustment Type</i> IE is equal to "Individual".
CommonOrIndividual	The IE shall be present if the <i>Adjustment Type</i> IE is equal to "Common" or "Individual".

Range Bound	Explanation
<i>maxnoofRLs</i>	Maximum number of Radio Links for a UE

9.2.1.6 Cause

IE/Group Name	Presence	Range	IE Type and Reference	Semantics Description
CHOICE Cause Group	M			
>Radio Network Layer				
>>Radio Network Layer Cause	M		ENUMERATED ( unknown C-ID, Cell not available, Power level not supported, DL radio resources not available, UL radio resources not available, RL Already Activated/allocated, Node B Resources Unavailable, Measurement not supported for the object, Combining Resources not available, Requested configuration not supported, Synchronization failure, Priority transport channel established, SIB Origination in Node B not Supported, Requested Tx Diversity Mode not supported, Unspecified, BCCH scheduling error, Measurement Temporarily not Available, Invalid CM Setting, Reconfiguration CFN not elapsed, Number of DL codes not supported, S-CPICH not supported, Combining not supported, UL SF not supported, DL SF not supported, Common Transport Channel Type not supported, Dedicated Transport Channel Type not supported, Downlink Shared Channel Type not supported, Uplink Shared Channel Type not supported, CM not supported, Tx diversity no longer supported, Unknown Local Cell ID, ..., Number of UL codes not supported, Information temporarily not available, Information Provision not supported for the object, Cell Synchronisation not supported, Cell Synchronisation Adjustment not supported, DPC Mode Change not Supported,	

			IPDL already activated, IPDL not supported, IPDL parameters not available, Frequency Acquisition not supported, Power Balancing status not compatible, Requested type of Bearer Re-arrangement not supported, Signalling Bearer Re-arrangement not supported, Bearer Re-arrangement needed, Delayed Activation not Supported, RL Timing Adjustment not supported, MICH not supported, HARQ Preamble Mode not supported, <a href="#">F-DPCH Not Supported</a> )	
<i>&gt;Transport Layer</i>				
>>Transport Layer Cause	M		ENUMERATED ( Transport resource unavailable, Unspecified, ...)	
<i>&gt;Protocol</i>				
>>Protocol Cause	M		ENUMERATED ( Transfer syntax error, Abstract syntax error (reject), Abstract syntax error (ignore and notify), Message not compatible with receiver state, Semantic error, Unspecified, Abstract syntax error (falsely constructed message), ...)	
<i>&gt;Misc</i>				
>>Miscellaneous Cause	M		ENUMERATED ( Control processing overload Hardware failure, O&M intervention, Not enough user plane processing resources, Unspecified, ...)	

The meaning of the different cause values is described in the following table. In general, "not supported" cause values indicate that the concerned capability is missing. On the other hand, "not available" cause values indicate that the concerned capability is present, but insufficient resources were available to perform the requested action.

<b>Radio Network Layer cause</b>	<b>Meaning</b>
BCCH scheduling error	The Node B has detected an illegal BCCH schedule update (see subclause 8.2.16.3).
Bearer Re-arrangement needed	The Node B cannot perform the requested Radio Link Reconfiguration without bearer re-arrangement.

Cell not Available	The concerned cell or local cell is not available.
Cell Synchronisation not supported	The concerned cell(s) do not support Cell Synchronisation.
Combining not supported	The Node B does not support RL combining for the concerned cells.
Combining Resources Not Available	The value of the received <i>Diversity Control Field</i> IE was set to "Must", but the Node B cannot perform the requested combining.
CM not supported	The concerned cell(s) do not support Compressed Mode.
Common Transport Channel Type not supported	The concerned cell(s) do not support the RACH and/or FACH and/or CPCH Common Transport Channel Type.
Dedicated Transport Channel Type not supported	The concerned cell(s) do not support the Dedicated Transport Channel Type.
Delayed Activation not Supported	The concerned cell(s) do not support delayed activation of RLs.
DL Radio Resources not Available	The Node B does not have sufficient DL radio resources available.
DL SF not supported	The concerned cell(s) do not support the requested DL SF.
DL Shared Channel Type not supported	The concerned cell(s) do not support the Downlink Shared Channel Type.
DPC Mode Change not Supported	The concerned cells do not support DPC mode changes.
Frequency Acquisition not supported	The concerned cell(s) do not support Frequency Acquisition.
<u>F-DPCH Not Supported</u>	<u>The concerned cell(s) do not support the Fractional DPCH</u>
HARQ Preamble Mode not supported	The concerned cell does not support the HARQ Preamble Mode
Information Provision not supported for the object	The requested information provision is not supported for the concerned object types.
Information temporarily not available	The requested information can temporarily not be provided.
Invalid CM Settings	The concerned cell(s) consider the requested Compressed Mode settings invalid.
IPDL already activated	The concerned cell(s) have already active IPDL ongoing.
IPDL not supported	The concerned cell(s) do not support the IPDL.
IPDL parameters not available	The concerned cell(s) do not have IPDL parameters defining IPDL to be applied.
Measurement not Supported For The Object	At least one of the concerned cell(s) does not support the requested measurement on the concerned object type.
Measurement Temporarily not Available	The Node B can temporarily not provide the requested measurement value.
MICH not supported	The concerned cell does not support MICH.
Node B resources unavailable	The Node B does not have sufficient resources available.
Number of DL codes not supported	The concerned cell(s) do not support the requested number of DL codes.
Number of UL codes not supported	The concerned cell(s) do not support the requested number of UL codes.
Power Level not Supported	A DL power level was requested which the concerned cell(s) do not support.
Power Balancing status not compatible	The power balancing status in the SRNC is not compatible with that of the Node B.
Priority transport channel established	The CRNC cannot perform the requested blocking since a transport channel with a high priority is present.
RL Timing Adjustment not Supported	The concerned cell(s) do not support adjustments of the RL timing.
Reconfiguration CFN not elapsed	The requested action cannot be performed due to that a RADIO LINK RECONFIGURATION COMMIT message was received previously, but the concerned CFN has not yet elapsed.
Requested Configuration not Supported	The concerned cell(s) do not support the requested configuration i.e. power levels, Transport Formats, physical channel parameters.
Requested Type of Bearer Re-arrangement not supported	The Node B does not support the requested type of bearer re-arrangement.
Requested Tx Diversity mode not supported	The concerned cell(s) do not support the requested transmit diversity mode.
RL already Activated/ allocated	The Node B has already allocated an RL with the requested RL-id for this UE context.
S-CPICH not supported	The concerned cell(s) do not support S-CPICH.
SIB Origination in Node B not Supported	The Node B does not support the origination of the requested SIB for the concerned cell.
Signalling Bearer Re-arrangement not supported	The Node B does not support the Signalling bearer re-arrangement.
Synchronisation Failure	Loss of UL Uu synchronisation.

Cell Synchronisation Adjustment not supported	The concerned cell(s) do not support Cell Synchronisation Adjustment.
Tx diversity no longer supported	Tx diversity can no longer be supported in the concerned cell.
UL Radio Resources not Available	The Node B does not have sufficient UL radio resources available.
UL SF not supported	The concerned cell(s) do not support the requested minimum UL SF.
UL Shared Channel Type not supported	The concerned cell(s) do not support the Uplink Shared Channel Type.
Unknown C-ID	The Node B is not aware of a cell with the provided C-ID.
Unknown Local Cell ID	The Node B is not aware of a local cell with the provided Local Cell ID
Unspecified	Sent when none of the above cause values applies but still the cause is Radio Network layer related.

<b>Transport Network Layer cause</b>	<b>Meaning</b>
Transport resource unavailable	The required transport resources are not available.
Unspecified	Sent when none of the above cause values applies but still the cause is Transport Network layer related.

<b>Protocol cause</b>	<b>Meaning</b>
Abstract Syntax Error (Reject)	The received message included an abstract syntax error and the concerned criticality indicated "reject" (see subclause 10.3).
Abstract Syntax Error (Ignore and Notify)	The received message included an abstract syntax error and the concerned criticality indicated "ignore and notify" (see subclause 10.3).
Abstract syntax error (falsely constructed message)	The received message contained IEs in wrong order or with too many occurrences (see subclause 10.3).
Message not Compatible with Receiver State	The received message was not compatible with the receiver state (see subclause 10.4).
Semantic Error	The received message included a semantic error (see subclause 10.4).
Transfer Syntax Error	The received message included a transfer syntax error (see subclause 10.2).
Unspecified	Sent when none of the above cause values applies but still the cause is protocol related.

<b>Miscellaneous cause</b>	<b>Meaning</b>
Control Processing Overload	Node B control processing overload.
Hardware Failure	Node B hardware failure.
Not enough User Plane Processing Resources	Node B has insufficient user plane processing resources available.
O&M Intervention	Operation and Maintenance intervention related to Node B equipment.
Unspecified	Sent when none of the above cause values applies and the cause is not related to any of the categories Radio Network Layer, Transport Network Layer or Protocol.

UNCHANGED TEXT IS REMOVED

### 9.2.1.21 DL Power

The *DL Power* IE indicates a power level relative to the [FDD - primary CPICH power] [TDD - primary CCPCH power] configured in a cell. If Transmit Diversity is applied to a downlink physical channel, the *DL Power* IE indicates the power offset between the linear sum of the power for this downlink physical channel on all branches and the [FDD - primary CPICH power] [TDD - PCCPCH power] configured in a cell.

[FDD - If referred to a DPCH, it indicates the power of the transmitted DPDCH symbols.] [\[FDD - If referred to an F-DPCH, it indicates the Reference F-DPCH TX Power.\]](#) [FDD - If referred to a DL-DPCCH for CPCH, it indicates the power of the transmitted pilot symbols].

[TDD - If referred to a DPCH or PDSCH, it indicates the power of a spreading factor 16 code, the power for a spreading factor 1 code would be 12 dB higher. If referred to a SCCPCH, the *DL Power* IE specifies the maximum power of the SCCPCH.]

IE/Group Name	Presence	Range	IE Type and Reference	Semantics Description
DL Power			INTEGER (-350..150)	Value = DL Power /10 Unit: dB Range: -35.0 .. +15.0 dB Step: 0.1dB

UNCHANGED TEXT IS REMOVED

### 9.2.2.2 Chip Offset

The Chip Offset is defined as the radio timing offset inside a radio frame. The Chip offset is used as offset ~~for the DL DPCH~~ relative to the Primary CPICH timing [for the DL DPCH or for the F-DPCH](#).

IE/Group Name	Presence	Range	IE Type and Reference	Semantics Description
Chip Offset			INTEGER (0..38399)	Unit: chips

UNCHANGED TEXT IS REMOVED

## 9.2.2.12B DL Power Balancing Information

The *DL Power Balancing Information* IE provides information for power balancing to be activated in the relevant RL(s).

IE/Group Name	Presence	Range	IE Type and Reference	Semantics Description
Power Adjustment Type	M		9.2.2.27	
DL Reference Power	C-Common		DL Power 9.2.1.21	Power on DPCH <a href="#">or on F-DPCH</a>
<b>DL Reference Power Information</b>	C-Individual	1..<maxno ofRLs>		
>RL ID	M		9.2.1.53	
>DL Reference Power	M		DL Power 9.2.1.21	Power on DPCH <a href="#">or on F-DPCH</a>
Max Adjustment Step	C-Common Or Individual		9.2.2.20	
Adjustment Period	C-Common Or Individual		9.2.2.B	
Adjustment Ratio	C-Common Or Individual		9.2.2.C	

Condition	Explanation
Common	The IE shall be present if the <i>Power Adjustment Type</i> IE is set to "Common".
Individual	The IE shall be present if the <i>Power Adjustment Type</i> IE is set to "Individual".
CommonOrIndividual	The IE shall be present if the <i>Power Adjustment Type</i> IE is set to "Common" or "Individual".

Range Bound	Explanation
<i>maxnoofRLs</i>	Maximum number of Radio Links for a UE

UNCHANGED TEXT IS REMOVED

## 9.2.2.29 Power Offset

This IE defines a power offset relative to the Downlink transmission power of a DPDCH [in case the Node B Communication Context is configured to use DPCH in the downlink or relative to the Reference F-DPCH TX Power in case the Node B Communication Context is configured to use F-DPCH in the downlink](#) or [relative to](#) a Secondary CCPCH data field or [relative to](#) a DL-DPCCH for CPCH pilot field..

IE/Group Name	Presence	Range	IE Type and Reference	Semantics Description
Power Offset			INTEGER (0..24)	Unit: dB Range: 0..6 dB Step: 0.25 dB



### 9.3.3 PDU Definitions

```
-- *****
--
-- PDU definitions for NBAP.
--
-- *****

NBAP-PDU-Contents {
itu-t (0) identified-organization (4) etsi (0) mobileDomain (0)
umts-Access (20) modules (3) nbap (2) version1 (1) nbap-PDU-Contents (1) }

DEFINITIONS AUTOMATIC TAGS ::=

BEGIN

-- *****
--
-- IE parameter types from other modules.
--
-- *****

IMPORTS

UNCHANGED TEXT IS REMOVED

    id-Active-Pattern-Sequence-Information,
    id-Additional-S-CCPCH-Parameters-CTCH-ReconfRqstTDD,
    id-Additional-S-CCPCH-Parameters-CTCH-SetupRqstTDD,
    id-Additional-S-CCPCH-LCR-Parameters-CTCH-ReconfRqstTDD,
    id-Additional-S-CCPCH-LCR-Parameters-CTCH-SetupRqstTDD,
    id-AdjustmentRatio,
    id-AICH-Information,
    id-AICH-ParametersListIE-CTCH-ReconfRqstFDD,
    id-AP-AICH-Information,
    id-AP-AICH-ParametersListIE-CTCH-ReconfRqstFDD,
    id-BCH-Information,
    id-BCCH-ModificationTime,
    id-bindingID,
    id-BlockingPriorityIndicator,
    id-Cause,
    id-CauseLevel-PSCH-ReconfFailure,
    id-CauseLevel-RL-AdditionFailureFDD,
    id-CauseLevel-RL-AdditionFailureTDD,
    id-CauseLevel-RL-ReconfFailure,
    id-CauseLevel-RL-SetupFailureFDD,
    id-CauseLevel-RL-SetupFailureTDD,
    id-CauseLevel-SyncAdjustmntFailureTDD,
    id-CCP-InformationItem-AuditRsp,
    id-CCP-InformationList-AuditRsp,
    id-CCP-InformationItem-ResourceStatusInd,
```

id-CCTrCH-InformationItem-RL-FailureInd,  
id-CCTrCH-InformationItem-RL-RestoreInd,  
id-CCTrCH-Initial-DL-Power-RL-AdditionRqstTDD,  
id-CCTrCH-Initial-DL-Power-RL-ReconfPrepTDD,  
id-CCTrCH-Initial-DL-Power-RL-SetupRqstTDD,  
id-CDCA-ICH-Information,  
id-CDCA-ICH-ParametersListIE-CTCH-ReconfRqstFDD,  
id-CellAdjustmentInfo-SyncAdjustmntRqstTDD,  
id-CellAdjustmentInfoItem-SyncAdjustmentRqstTDD,  
id-Cell-InformationItem-AuditRsp,  
id-Cell-InformationItem-ResourceStatusInd,  
id-Cell-InformationList-AuditRsp,  
id-CellParameterID,  
id-CellPortion-InformationItem-Cell-SetupRqstFDD,  
id-CellPortion-InformationList-Cell-SetupRqstFDD,  
id-CellSyncBurstTransInit-CellSyncInitiationRqstTDD,  
id-CellSyncBurstMeasureInit-CellSyncInitiationRqstTDD,  
id-cellSyncBurstRepetitionPeriod,  
id-CellSyncBurstTransReconfiguration-CellSyncReconfRqstTDD,  
id-CellSyncBurstTransReconfInfo-CellSyncReconfRqstTDD,  
id-CellSyncBurstMeasReconfiguration-CellSyncReconfRqstTDD,  
id-CellSyncBurstMeasInfoList-CellSyncReconfRqstTDD,  
id-CellSyncBurstInfoList-CellSyncReconfRqstTDD,  
id-CellSyncInfo-CellSyncReprtTDD,  
id-CFN,  
id-CFNReportingIndicator,  
id-C-ID,  
id-Closed-Loop-Timing-Adjustment-Mode,  
id-CommonMeasurementAccuracy,  
id-CommonMeasurementObjectType-CM-Rprt,  
id-CommonMeasurementObjectType-CM-Rqst,  
id-CommonMeasurementObjectType-CM-Rsp,  
id-CommonMeasurementType,  
id-CommonPhysicalChannelID,  
id-CommonPhysicalChannelType-CTCH-ReconfRqstFDD,  
id-CommonPhysicalChannelType-CTCH-SetupRqstFDD,  
id-CommonPhysicalChannelType-CTCH-SetupRqstTDD,  
id-CommunicationContextInfoItem-Reset,  
id-CommunicationControlPortID,  
id-CommunicationControlPortInfoItem-Reset,  
id-Compressed-Mode-Deactivation-Flag,  
id-ConfigurationGenerationID,  
id-CPCH-Information,  
id-CPCH-Parameters-CTCH-SetupRsp,  
id-CPCH-ParametersListIE-CTCH-ReconfRqstFDD,  
id-CRNC-CommunicationContextID,  
id-CriticalityDiagnostics,  
id-CSBTransmissionID,  
id-CSBMeasurementID,  
id-DCHs-to-Add-FDD,  
id-DCHs-to-Add-TDD,  
id-DCH-AddList-RL-ReconfPrepTDD,  
id-DCH-DeleteList-RL-ReconfPrepFDD,

id-DCH-DeleteList-RL-ReconfPrepTDD,  
 id-DCH-DeleteList-RL-ReconfRqstFDD,  
 id-DCH-DeleteList-RL-ReconfRqstTDD,  
 id-DCH-FDD-Information,  
 id-DCH-TDD-Information,  
 id-DCH-InformationResponse,  
 id-DCH-RearrangeList-Bearer-RearrangeInd,  
 id-DSCH-RearrangeList-Bearer-RearrangeInd,  
 id-FDD-DCHs-to-Modify,  
 id-TDD-DCHs-to-Modify,  
 id-DedicatedMeasurementObjectType-DM-Rprrt,  
 id-DedicatedMeasurementObjectType-DM-Rqst,  
 id-DedicatedMeasurementObjectType-DM-Rsp,  
 id-DedicatedMeasurementType,  
 id-DelayedActivation,  
 id-DelayedActivationList-RL-ActivationCmdFDD,  
 id-DelayedActivationList-RL-ActivationCmdTDD,  
 id-DelayedActivationInformation-RL-ActivationCmdFDD,  
 id-DelayedActivationInformation-RL-ActivationCmdTDD,  
 id-DL-CCTrCH-InformationAddList-RL-ReconfPrepTDD,  
 id-DL-CCTrCH-InformationDeleteItem-RL-ReconfRqstTDD,  
 id-DL-CCTrCH-InformationDeleteList-RL-ReconfPrepTDD,  
 id-DL-CCTrCH-InformationDeleteList-RL-ReconfRqstTDD,  
 id-DL-CCTrCH-InformationItem-RL-SetupRqstTDD,  
 id-DL-CCTrCH-InformationList-RL-AdditionRqstTDD,  
 id-DL-CCTrCH-InformationList-RL-SetupRqstTDD,  
 id-DL-CCTrCH-InformationModifyItem-RL-ReconfRqstTDD,  
 id-DL-CCTrCH-InformationModifyList-RL-ReconfPrepTDD,  
 id-DL-CCTrCH-InformationModifyList-RL-ReconfRqstTDD,  
 id-DL-DPCH-InformationAddListIE-RL-ReconfPrepTDD,  
 id-DL-DPCH-InformationItem-RL-AdditionRqstTDD,  
 id-DL-DPCH-InformationList-RL-SetupRqstTDD,  
 id-DL-DPCH-InformationModify-AddListIE-RL-ReconfPrepTDD,  
 id-DL-DPCH-InformationModify-DeleteListIE-RL-ReconfPrepTDD,  
 id-DL-DPCH-InformationModify-ModifyListIE-RL-ReconfPrepTDD,  
 id-DL-DPCH-Information-RL-ReconfPrepFDD,  
 id-DL-DPCH-Information-RL-ReconfRqstFDD,  
 id-DL-DPCH-Information-RL-SetupRqstFDD,  
 id-DL-DPCH-TimingAdjustment,  
[id-DL-DPCH-Power-Information-RL-ReconfPrepFDD](#),  
 id-DL-PowerBalancing-Information,  
 id-DL-PowerBalancing-ActivationIndicator,  
 id-DL-ReferencePowerInformationItem-DL-PC-Rqst,  
 id-DL-PowerBalancing-UpdatedIndicator,  
 id-DLReferencePower,  
 id-DLReferencePowerList-DL-PC-Rqst,  
 id-DL-TPC-Pattern01Count,  
 id-DPC-Mode,  
 id-DPCHConstant,  
 id-DSCH-AddItem-RL-ReconfPrepFDD,  
 id-DSCHs-to-Add-FDD,  
 id-DSCH-DeleteItem-RL-ReconfPrepFDD,  
 id-DSCH-DeleteList-RL-ReconfPrepFDD,

id-DSCHs-to-Add-TDD,  
id-DSCH-Information-DeleteList-RL-ReconfPrepTDD,  
id-DSCH-Information-ModifyList-RL-ReconfPrepTDD,  
id-DSCH-InformationResponse,  
id-DSCH-FDD-Information,  
id-DSCH-FDD-Common-Information,  
id-DSCH-TDD-Information,  
id-DSCH-ModifyItem-RL-ReconfPrepFDD,  
id-DSCH-ModifyList-RL-ReconfPrepFDD,  
id-End-Of-Audit-Sequence-Indicator,  
id-EnhancedDSCHPC,  
id-EnhancedDSCHPCIndicator,  
id-FACH-Information,  
id-FACH-ParametersList-CTCH-ReconfRqstTDD,  
id-FACH-ParametersList-CTCH-SetupRsp,  
id-FACH-ParametersListIE-CTCH-ReconfRqstFDD,  
id-FACH-ParametersListIE-CTCH-SetupRqstFDD,  
id-FACH-ParametersListIE-CTCH-SetupRqstTDD,  
[id-F-DPCH-Information-RL-ReconfPrepFDD,](#)  
[id-F-DPCH-Information-RL-SetupRqstFDD,](#)  
id-IndicationType-ResourceStatusInd,  
id-InformationExchangeID,  
id-InformationExchangeObjectType-InfEx-Rqst,  
id-InformationExchangeObjectType-InfEx-Rsp,  
id-InformationExchangeObjectType-InfEx-Rprt,  
id-InformationReportCharacteristics,  
id-InformationType,  
id-InitDL-Power,  
id-InnerLoopDLPCStatus,  
id-IntStdPhCellSyncInfoItem-CellSyncReprtTDD,  
id-IPDLParameter-Information-Cell-ReconfRqstFDD,  
id-IPDLParameter-Information-Cell-SetupRqstFDD,  
id-IPDLParameter-Information-Cell-ReconfRqstTDD,  
id-IPDLParameter-Information-Cell-SetupRqstTDD,  
id-LateEntranceCellSyncInfoItem-CellSyncReprtTDD,  
id-Limited-power-increase-information-Cell-SetupRqstFDD,  
id-Local-Cell-ID,  
id-Local-Cell-Group-InformationItem-AuditRsp,  
id-Local-Cell-Group-InformationItem-ResourceStatusInd,  
id-Local-Cell-Group-InformationItem2-ResourceStatusInd,  
id-Local-Cell-Group-InformationList-AuditRsp,  
id-Local-Cell-InformationItem-AuditRsp,  
id-Local-Cell-InformationItem-ResourceStatusInd,  
id-Local-Cell-InformationItem2-ResourceStatusInd,  
id-Local-Cell-InformationList-AuditRsp,  
id-AdjustmentPeriod,  
id-MaxAdjustmentStep,  
id-MaximumTransmissionPower,  
id-MeasurementFilterCoefficient,  
id-MeasurementID,  
id-MeasurementRecoveryBehavior,  
id-MeasurementRecoveryReportingIndicator,  
id-MeasurementRecoverySupportIndicator,

id-MIB-SB-SIB-InformationList-SystemInfoUpdateRqst,  
id-MICH-CFN,  
id-MICH-Information-AuditRsp,  
id-MICH-Information-ResourceStatusInd,  
id-MICH-Parameters-CTCH-ReconfRqstFDD,  
id-MICH-Parameters-CTCH-ReconfRqstTDD,  
id-MICH-Parameters-CTCH-SetupRqstFDD,  
id-MICH-Parameters-CTCH-SetupRqstTDD,  
id-Modification-Period,  
id-multipleRL-dl-DPCH-InformationList,  
id-multipleRL-dl-DPCH-InformationModifyList,  
id-multiple-RL-Information-RL-ReconfPrepTDD,  
id-multiple-RL-Information-RL-ReconfRqstTDD,  
id-multipleRL-ul-DPCH-InformationList,  
id-multipleRL-ul-DPCH-InformationModifyList,  
id-NCyclesPerSFNperiod,  
id-NeighbouringCellMeasurementInformation,  
id-NI-Information-NotifUpdateCmd,  
id-NodeB-CommunicationContextID,  
id-NRepetitionsPerCyclePeriod,  
id-NumberOfReportedCellPortions,  
id-P-CCPCH-Information,  
id-P-CPICH-Information,  
id-P-SCH-Information,  
id-PCCPCH-Information-Cell-ReconfRqstTDD,  
id-PCCPCH-Information-Cell-SetupRqstTDD,  
id-PCH-Parameters-CTCH-ReconfRqstTDD,  
id-PCH-Parameters-CTCH-SetupRsp,  
id-PCH-ParametersItem-CTCH-ReconfRqstFDD,  
id-PCH-ParametersItem-CTCH-SetupRqstFDD,  
id-PCH-ParametersItem-CTCH-SetupRqstTDD,  
id-PCH-Information,  
id-PCPCH-Information,  
id-PICH-ParametersItem-CTCH-ReconfRqstFDD,  
id-PDSCH-Information-AddListIE-PSCH-ReconfRqst,  
id-PDSCH-Information-Cell-SetupRqstFDD,  
id-PDSCH-Information-Cell-ReconfRqstFDD,  
id-PDSCH-Information-ModifyListIE-PSCH-ReconfRqst,  
id-PDSCH-RL-ID,  
id-PDSCHSets-AddList-PSCH-ReconfRqst,  
id-PDSCHSets-DeleteList-PSCH-ReconfRqst,  
id-PDSCHSets-ModifyList-PSCH-ReconfRqst,  
id-PICH-Information,  
id-PICH-Parameters-CTCH-ReconfRqstTDD,  
id-PICH-ParametersItem-CTCH-SetupRqstTDD,  
id-PowerAdjustmentType,  
id-Power-Local-Cell-Group-InformationItem-AuditRsp,  
id-Power-Local-Cell-Group-InformationItem-ResourceStatusInd,  
id-Power-Local-Cell-Group-InformationItem2-ResourceStatusInd,  
id-Power-Local-Cell-Group-InformationList-AuditRsp,  
id-Power-Local-Cell-Group-InformationList-ResourceStatusInd,  
id-Power-Local-Cell-Group-InformationList2-ResourceStatusInd,  
id-Power-Local-Cell-Group-ID,

id-PRACH-Information,  
id-PRACHConstant,  
id-PRACH-ParametersItem-CTCH-SetupRqstTDD,  
id-PRACH-ParametersListIE-CTCH-ReconfRqstFDD,  
id-PrimaryCCPCH-Information-Cell-ReconfRqstFDD,  
id-PrimaryCCPCH-Information-Cell-SetupRqstFDD,  
id-PrimaryCPICH-Information-Cell-ReconfRqstFDD,  
id-PrimaryCPICH-Information-Cell-SetupRqstFDD,  
id-Primary-CPICH-Usage-for-Channel-Estimation,  
id-PrimarySCH-Information-Cell-ReconfRqstFDD,  
id-PrimarySCH-Information-Cell-SetupRqstFDD,  
id-PrimaryScramblingCode,  
id-SCH-Information-Cell-ReconfRqstTDD,  
id-SCH-Information-Cell-SetupRqstTDD,  
id-PUSCH-Information-AddListIE-PSCH-ReconfRqst,  
id-PUSCH-Information-ModifyListIE-PSCH-ReconfRqst,  
id-PUSCHConstant,  
id-PUSCHSets-AddList-PSCH-ReconfRqst,  
id-PUSCHSets-DeleteList-PSCH-ReconfRqst,  
id-PUSCHSets-ModifyList-PSCH-ReconfRqst,  
id-Qth-Parameter,  
id-RACH-Information,  
id-RACH-Parameters-CTCH-SetupRsp,  
id-RACH-ParametersItem-CTCH-SetupRqstFDD,  
id-RACH-ParameterItem-CTCH-SetupRqstTDD,  
id-ReferenceClockAvailability,  
id-ReferenceSFNOffset,  
id-ReportCharacteristics,  
id-Reporting-Object-RL-FailureInd,  
id-Reporting-Object-RL-RestoreInd,  
id-ResetIndicator,  
id-RL-ID,  
id-RL-InformationItem-DM-Rprt,  
id-RL-InformationItem-DM-Rqst,  
id-RL-InformationItem-DM-Rsp,  
id-RL-InformationItem-RL-AdditionRqstFDD,  
id-RL-informationItem-RL-DeletionRqst,  
id-RL-InformationItem-RL-FailureInd,  
id-RL-InformationItem-RL-PreemptRequiredInd,  
id-RL-InformationItem-RL-ReconfPrepFDD,  
id-RL-InformationItem-RL-ReconfRqstFDD,  
id-RL-InformationItem-RL-RestoreInd,  
id-RL-InformationItem-RL-SetupRqstFDD,  
id-RL-InformationList-RL-AdditionRqstFDD,  
id-RL-informationList-RL-DeletionRqst,  
id-RL-InformationList-RL-PreemptRequiredInd,  
id-RL-InformationList-RL-ReconfPrepFDD,  
id-RL-InformationList-RL-ReconfRqstFDD,  
id-RL-InformationList-RL-SetupRqstFDD,  
id-RL-InformationResponseItem-RL-AdditionRspFDD,  
id-RL-InformationResponseItem-RL-ReconfReady,  
id-RL-InformationResponseItem-RL-ReconfRsp,  
id-RL-InformationResponseItem-RL-SetupRspFDD,

id-RL-InformationResponseList-RL-AdditionRspFDD,  
id-RL-InformationResponseList-RL-ReconfReady,  
id-RL-InformationResponseList-RL-ReconfRsp,  
id-RL-InformationResponseList-RL-SetupRspFDD,  
id-RL-InformationResponse-RL-AdditionRspTDD,  
id-RL-InformationResponse-RL-SetupRspTDD,  
id-RL-Information-RL-AdditionRqstTDD,  
id-RL-Information-RL-ReconfRqstTDD,  
id-RL-Information-RL-ReconfPrepTDD,  
id-RL-Information-RL-SetupRqstTDD,  
id-RL-ReconfigurationFailureItem-RL-ReconfFailure,  
id-RL-Set-InformationItem-DM-Rprt,  
id-RL-Set-InformationItem-DM-Rsp,  
id-RL-Set-InformationItem-RL-FailureInd,  
id-RL-Set-InformationItem-RL-RestoreInd,  
id-RL-Specific-DCH-Info,  
id-S-CCPCH-Information,  
id-S-CCPCH-InformationListExt-AuditRsp,  
id-S-CCPCH-InformationListExt-ResourceStatusInd,  
id-S-CCPCH-LCR-InformationListExt-AuditRsp,  
id-S-CCPCH-LCR-InformationListExt-ResourceStatusInd,  
id-S-CPICH-Information,  
id-SCH-Information,  
id-S-SCH-Information,  
id-Secondary-CCPCHListIE-CTCH-ReconfRqstTDD,  
id-Secondary-CCPCH-parameterListIE-CTCH-SetupRqstTDD,  
id-Secondary-CCPCH-Parameters-CTCH-ReconfRqstTDD,  
id-Secondary-CPICH-Information,  
id-SecondaryCPICH-InformationItem-Cell-ReconfRqstFDD,  
id-SecondaryCPICH-InformationItem-Cell-SetupRqstFDD,  
id-SecondaryCPICH-InformationList-Cell-ReconfRqstFDD,  
id-SecondaryCPICH-InformationList-Cell-SetupRqstFDD,  
id-Secondary-CPICH-Information-Change,  
id-SecondarySCH-Information-Cell-ReconfRqstFDD,  
id-SecondarySCH-Information-Cell-SetupRqstFDD,  
id-SegmentInformationListIE-SystemInfoUpdate,  
id-SFN,  
id-SFNReportingIndicator,  
id-ShutdownTimer,  
id-SignallingBearerRequestIndicator,  
id-SSDT-CellIDforEDSCHPC,  
id-Start-Of-Audit-Sequence-Indicator,  
id-Successful-RL-InformationRespItem-RL-AdditionFailureFDD,  
id-Successful-RL-InformationRespItem-RL-SetupFailureFDD,  
id-Synchronisation-Configuration-Cell-ReconfRqst,  
id-Synchronisation-Configuration-Cell-SetupRqst,  
id-SyncCase,  
id-SyncCaseIndicatorItem-Cell-SetupRqstTDD-PSCH,  
id-SyncFrameNumber,  
id-SynchronisationReportType,  
id-SynchronisationReportCharacteristics,  
id-SyncReportType-CellSyncReprtTDD,  
id-T-Cell,

id-TargetCommunicationControlPortID,  
id-TFCI2-Bearer-Information-RL-SetupRqstFDD,  
id-TFCI2-BearerInformationResponse,  
id-TFCI2BearerRequestIndicator,  
id-TFCI2-BearerSpecificInformation-RL-ReconfPrepFDD,  
id-Transmission-Gap-Pattern-Sequence-Information,  
id-TimeSlotConfigurationList-Cell-ReconfRqstTDD,  
id-TimeSlotConfigurationList-Cell-SetupRqstTDD,  
id-timeslotInfo-CellSyncInitiationRqstTDD,  
id-TimeslotISCPInfo,  
id-TimingAdvanceApplied,  
id-TnlQos,  
id-TransmissionDiversityApplied,  
id-transportlayeraddress,  
id-Tstd-indicator,  
id-UARFCNforNt,  
id-UARFCNforNd,  
id-UARFCNforNu,  
id-UL-CCTrCH-InformationAddList-RL-ReconfPrepTDD,  
id-UL-CCTrCH-InformationDeleteItem-RL-ReconfRqstTDD,  
id-UL-CCTrCH-InformationDeleteList-RL-ReconfPrepTDD,  
id-UL-CCTrCH-InformationDeleteList-RL-ReconfRqstTDD,  
id-UL-CCTrCH-InformationItem-RL-SetupRqstTDD,  
id-UL-CCTrCH-InformationList-RL-AdditionRqstTDD,  
id-UL-CCTrCH-InformationList-RL-SetupRqstTDD,  
id-UL-CCTrCH-InformationModifyItem-RL-ReconfRqstTDD,  
id-UL-CCTrCH-InformationModifyList-RL-ReconfPrepTDD,  
id-UL-CCTrCH-InformationModifyList-RL-ReconfRqstTDD,  
id-UL-DPCH-InformationAddListIE-RL-ReconfPrepTDD,  
id-UL-DPCH-InformationItem-RL-AdditionRqstTDD,  
id-UL-DPCH-InformationList-RL-SetupRqstTDD,  
id-UL-DPCH-InformationModify-AddListIE-RL-ReconfPrepTDD,  
id-UL-DPCH-InformationModify-DeleteListIE-RL-ReconfPrepTDD,  
id-UL-DPCH-InformationModify-ModifyListIE-RL-ReconfPrepTDD,  
id-UL-DPCH-Information-RL-ReconfPrepFDD,  
id-UL-DPCH-Information-RL-ReconfRqstFDD,  
id-UL-DPCH-Information-RL-SetupRqstFDD,  
id-Unsuccessful-cell-InformationRespItem-SyncAdjustmntFailureTDD,  
id-Unsuccessful-PDSCHSetItem-PSCH-ReconfFailureTDD,  
id-Unsuccessful-PUSCHSetItem-PSCH-ReconfFailureTDD,  
id-Unsuccessful-RL-InformationRespItem-RL-AdditionFailureFDD,  
id-Unsuccessful-RL-InformationRespItem-RL-SetupFailureFDD,  
id-Unsuccessful-RL-InformationResp-RL-AdditionFailureTDD,  
id-Unsuccessful-RL-InformationResp-RL-SetupFailureTDD,  
id-USCH-Information-Add,  
id-USCH-Information-DeleteList-RL-ReconfPrepTDD,  
id-USCH-Information-ModifyList-RL-ReconfPrepTDD,  
id-USCH-InformationResponse,  
id-USCH-Information,  
id-USCH-RearrangeList-Bearer-RearrangeInd,  
id-DL-DPCH-LCR-Information-RL-SetupRqstTDD,  
id-DwPCH-LCR-Information ,  
id-DwPCH-LCR-InformationList-AuditRsp,



id-DwPCH-LCR-Information-Cell-SetupRqstTDD,  
id-DwPCH-LCR-Information-Cell-ReconfRqstTDD,  
id-DwPCH-LCR-Information-ResourceStatusInd,  
id-maxFACH-Power-LCR-CTCH-SetupRqstTDD,  
id-maxFACH-Power-LCR-CTCH-ReconfRqstTDD,  
id-FPACH-LCR-Information,  
id-FPACH-LCR-Information-AuditRsp,  
id-FPACH-LCR-InformationList-AuditRsp,  
id-FPACH-LCR-InformationList-ResourceStatusInd,  
id-FPACH-LCR-Parameters-CTCH-SetupRqstTDD,  
id-FPACH-LCR-Parameters-CTCH-ReconfRqstTDD,  
id-PCCPCH-LCR-Information-Cell-SetupRqstTDD,  
id-PCH-Power-LCR-CTCH-SetupRqstTDD,  
id-PCH-Power-LCR-CTCH-ReconfRqstTDD,  
id-PICH-LCR-Parameters-CTCH-SetupRqstTDD,  
id-PRACH-LCR-ParametersList-CTCH-SetupRqstTDD,  
id-RL-InformationResponse-LCR-RL-SetupRspTDD ,  
id-Secondary-CCPCH-LCR-parameterList-CTCH-SetupRqstTDD,  
id-TimeSlot,  
id-TimeSlotConfigurationList-LCR-Cell-ReconfRqstTDD,  
id-TimeSlotConfigurationList-LCR-Cell-SetupRqstTDD,  
id-TimeslotISCP-LCR-InfoList-RL-SetupRqstTDD,  
id-TimeSlotLCR-CM-Rqst ,  
id-UL-DPCH-LCR-Information-RL-SetupRqstTDD,  
id-DL-DPCH-InformationItem-LCR-RL-AdditionRqstTDD,  
id-UL-DPCH-InformationItem-LCR-RL-AdditionRqstTDD,  
id-TimeslotISCP-InformationList-LCR-RL-AdditionRqstTDD,  
id-DL-DPCH-LCR-InformationAddList-RL-ReconfPrepTDD,  
id-DL-DPCH-LCR-InformationModify-AddList-RL-ReconfPrepTDD,  
id-DL-Timeslot-LCR-InformationModify-ModifyList-RL-ReconfPrepTDD,  
id-TimeslotISCPInfoList-LCR-DL-PC-RqstTDD,  
id-UL-DPCH-LCR-InformationAddListIE-RL-ReconfPrepTDD,  
id-UL-DPCH-LCR-InformationModify-AddList,  
id-UL-TimeslotLCR-Information-RL-ReconfPrepTDD,  
id-UL-SIRTarget ,  
id-PDSCH-AddInformation-LCR-PSCH-ReconfRqst ,  
id-PDSCH-AddInformation-LCR-AddListIE-PSCH-ReconfRqst ,  
id-PDSCH-ModifyInformation-LCR-PSCH-ReconfRqst ,  
id-PDSCH-ModifyInformation-LCR-ModifyListIE-PSCH-ReconfRqst ,  
id-PUSCH-AddInformation-LCR-PSCH-ReconfRqst ,  
id-PUSCH-AddInformation-LCR-AddListIE-PSCH-ReconfRqst ,  
id-PUSCH-ModifyInformation-LCR-PSCH-ReconfRqst ,  
id-PUSCH-ModifyInformation-LCR-ModifyListIE-PSCH-ReconfRqst ,  
id-PUSCH-Info-DM-Rqst ,  
id-PUSCH-Info-DM-Rsp ,  
id-PUSCH-Info-DM-Rprt ,  
id-RL-InformationResponse-LCR-RL-AdditionRspTDD,  
id-IPDLParameter-Information-LCR-Cell-SetupRqstTDD,  
id-IPDLParameter-Information-LCR-Cell-ReconfRqstTDD,  
id-HS-PDSCH-HS-SCCH-MaxPower-PSCH-ReconfRqst ,  
id-HS-PDSCH-HS-SCCH-ScramblingCode-PSCH-ReconfRqst ,  
id-HS-PDSCH-FDD-Code-Information-PSCH-ReconfRqst ,  
id-HS-SCCH-FDD-Code-Information-PSCH-ReconfRqst ,

id-HS-PDSCH-TDD-Information-PSCH-ReconfRqst,  
id-Add-To-HS-SCCH-Resource-Pool-PSCH-ReconfRqst,  
id-Modify-HS-SCCH-Resource-Pool-PSCH-ReconfRqst,  
id-Delete-From-HS-SCCH-Resource-Pool-PSCH-ReconfRqst,  
id-SYNCDlCodeId-TransInitLCR-CellSyncInitiationRqstTDD,  
id-SYNCDlCodeId-MeasureInitLCR-CellSyncInitiationRqstTDD,  
id-SYNCDlCodeIdTransReconfInfoLCR-CellSyncReconfRqstTDD,  
id-SYNCDlCodeIdMeasReconfigurationLCR-CellSyncReconfRqstTDD,  
id-SYNCDlCodeIdMeasInfoList-CellSyncReconfRqstTDD,  
id-SyncDLCodeIdsMeasInfoList-CellSyncReprtTDD,  
id-NSubCyclesPerCyclePeriod-CellSyncReconfRqstTDD,  
id-DwPCH-Power,  
id-AccumulatedClockupdate-CellSyncReprtTDD,  
id-HSDPA-Capability,  
id-HSDSCH-FDD-Information,  
id-HSDSCH-FDD-Information-Response,  
id-HSDSCH-Information-to-Modify,  
id-HSDSCH-Information-to-Modify-Unsynchronised,  
id-HSDSCH-MACdFlows-to-Add,  
id-HSDSCH-MACdFlows-to-Delete,  
id-HSDSCH-RearrangeList-Bearer-RearrangeInd,  
id-HSDSCH-Resources-Information-AuditRsp,  
id-HSDSCH-Resources-Information-ResourceStatusInd,  
id-HSDSCH-RNTI,  
id-HSDSCH-TDD-Information,  
id-HSDSCH-TDD-Information-Response,  
id-HSPDSCH-RL-ID,  
id-HSSICH-Info-DM-Rprt,  
id-HSSICH-Info-DM-Rqst,  
id-HSSICH-Info-DM-Rsp,  
id-PrimCCPCH-RSCP-DL-PC-RqstTDD,  
id-HSDSCH-FDD-Update-Information,  
id-HSDSCH-TDD-Update-Information,  
id-UL-Synchronisation-Parameters-LCR,  
id-DL-DPCH-TimeSlotFormat-LCR-ModifyItem-RL-ReconfPrepTDD,  
id-UL-DPCH-TimeSlotFormat-LCR-ModifyItem-RL-ReconfPrepTDD,  
id-CCTrCH-Maximum-DL-Power-RL-SetupRqstTDD,  
id-CCTrCH-Minimum-DL-Power-RL-SetupRqstTDD,  
id-CCTrCH-Maximum-DL-Power-RL-AdditionRqstTDD,  
id-CCTrCH-Minimum-DL-Power-RL-AdditionRqstTDD,  
id-CCTrCH-Maximum-DL-Power-InformationAdd-RL-ReconfPrepTDD,  
id-CCTrCH-Minimum-DL-Power-InformationAdd-RL-ReconfPrepTDD,  
id-CCTrCH-Maximum-DL-Power-InformationModify-RL-ReconfPrepTDD,  
id-CCTrCH-Minimum-DL-Power-InformationModify-RL-ReconfPrepTDD,  
id-Maximum-DL-Power-Modify-LCR-InformationModify-RL-ReconfPrepTDD,  
id-Minimum-DL-Power-Modify-LCR-InformationModify-RL-ReconfPrepTDD,  
id-DL-DPCH-LCR-InformationModify-ModifyList-RL-ReconfRqstTDD,  
id-CCTrCH-Maximum-DL-Power-InformationModify-RL-ReconfRqstTDD,  
id-CCTrCH-Minimum-DL-Power-InformationModify-RL-ReconfRqstTDD,  
id-TDD-TPC-UplinkStepSize-LCR-RL-SetupRqstTDD,  
id-TDD-TPC-UplinkStepSize-LCR-RL-AdditionRqstTDD,  
id-TDD-TPC-DownlinkStepSize-RL-AdditionRqstTDD,  
id-TDD-TPC-UplinkStepSize-InformationAdd-LCR-RL-ReconfPrepTDD,

id-TDD-TPC-UplinkStepSize-InformationModify-LCR-RL-ReconfPrepTDD,  
id-TDD-TPC-DownlinkStepSize-InformationModify-RL-ReconfPrepTDD,  
id-TDD-TPC-DownlinkStepSize-InformationAdd-RL-ReconfPrepTDD,  
id-TimeslotISCP-LCR-InfoList-RL-ReconfPrepTDD,  
id-TimingAdjustmentValueLCR,  
id-PrimaryCCPCH-RSCP-Delta,

UNCHANGED TEXT IS REMOVED

```

-- *****
--
-- RADIO LINK SETUP REQUEST FDD
--
-- *****

RadioLinkSetupRequestFDD ::= SEQUENCE {
    protocolIEs          ProtocolIE-Container    {{RadioLinkSetupRequestFDD-IEs}},
    protocolExtensions   ProtocolExtensionContainer {{RadioLinkSetupRequestFDD-Extensions}}          OPTIONAL,
    ...
}

RadioLinkSetupRequestFDD-IEs NBAP-PROTOCOL-IES ::= {
    { ID id-CRNC-CommunicationContextID          CRITICALITY reject TYPE CRNC-CommunicationContextID          PRESENCE mandatory }|
    { ID id-UL-DPCH-Information-RL-SetupRqstFDD  CRITICALITY reject TYPE UL-DPCH-Information-RL-SetupRqstFDD  PRESENCE mandatory }|
    { ID id-DL-DPCH-Information-RL-SetupRqstFDD  CRITICALITY reject TYPE DL-DPCH-Information-RL-SetupRqstFDD  PRESENCE
| optional mandatory }|
    { ID id-DCH-FDD-Information                  CRITICALITY reject TYPE DCH-FDD-Information                  PRESENCE mandatory }|
    { ID id-DSCH-FDD-Information                 CRITICALITY reject TYPE DSCH-FDD-Information                 PRESENCE optional }|
    { ID id-TFCI2-Bearer-Information-RL-SetupRqstFDD CRITICALITY ignore TYPE TFCI2-Bearer-Information-RL-SetupRqstFDD PRESENCE optional }|
    { ID id-RL-InformationList-RL-SetupRqstFDD   CRITICALITY notify TYPE RL-InformationList-RL-SetupRqstFDD   PRESENCE mandatory }|
    { ID id-Transmission-Gap-Pattern-Sequence-Information CRITICALITY reject TYPE Transmission-Gap-Pattern-Sequence-Information PRESENCE optional }|
    { ID id-Active-Pattern-Sequence-Information  CRITICALITY reject TYPE Active-Pattern-Sequence-Information  PRESENCE optional },
    ...
}

RadioLinkSetupRequestFDD-Extensions NBAP-PROTOCOL-EXTENSION ::= {
    { ID id-DSCH-FDD-Common-Information          CRITICALITY ignore EXTENSION DSCH-FDD-Common-Information          PRESENCE optional }|
    { ID id-DL-PowerBalancing-Information       CRITICALITY ignore EXTENSION DL-PowerBalancing-Information       PRESENCE optional }|
    { ID id-HSDSCH-FDD-Information              CRITICALITY reject EXTENSION HSDSCH-FDD-Information              PRESENCE optional }|
    { ID id-HSDSCH-RNTI                        CRITICALITY reject EXTENSION HSDSCH-RNTI                        PRESENCE conditional }|
    -- The IE shall be present if HS-DSCH Information IE is present
    { ID id-HSPDSCH-RL-ID                      CRITICALITY reject EXTENSION RL-ID                      PRESENCE conditional }|7
    -- The IE shall be present if HS-DSCH Information IE is present
| { ID ID id-F-DPCH-Information-RL-SetupRqstFDD CRITICALITY reject EXTENSION F-DPCH-Information-RL-SetupRqstFDD PRESENCE optional },
    ...
}

UL-DPCH-Information-RL-SetupRqstFDD ::= SEQUENCE {
    ul-ScramblingCode          UL-ScramblingCode,
    minUL-ChannelisationCodeLength  MinUL-ChannelisationCodeLength,
    maxNrOfUL-DPDCHs           MaxNrOfUL-DPDCHs          OPTIONAL,
    -- This IE shall be present if Min UL Channelisation Code length IE is set to 4 --
    ul-PunctureLimit           PunctureLimit,
    tFCS                        TFCS,
    ul-DPCCH-SlotFormat         UL-DPCCH-SlotFormat,
    ul-SIR-Target               UL-SIR,
    diversityMode               DiversityMode,
    sSDT-CellID-Length          SSdT-CellID-Length      OPTIONAL,
    s-FieldLength               S-FieldLength          OPTIONAL,
    iE-Extensions               ProtocolExtensionContainer { { UL-DPCH-Information-RL-SetupRqstFDD-ExtIEs} } OPTIONAL,
    ...
}

```

```

}
UL-DPCH-Information-RL-SetupRqstFDD-ExtIEs NBAP-PROTOCOL-EXTENSION ::= {
  { ID id-DPC-Mode          CRITICALITY reject  EXTENSION  DPC-Mode    PRESENCE optional  },
  ...
}
DL-DPCH-Information-RL-SetupRqstFDD ::= SEQUENCE {
  tFCS                TFCS,
  dl-DPCH-SlotFormat DL-DPCH-SlotFormat,
  tFCI-SignallingMode TFCI-SignallingMode,
  tFCI-Presence       TFCI-Presence OPTIONAL,
  -- this IE shall be present if the DL DPCH slot format IE is set to any of the values from 12 to 16 --
  multiplexingPosition MultiplexingPosition,
  pDSCH-RL-ID         RL-ID OPTIONAL,
  -- This IE shall be present if the DSCH Information IE is present --
  pDSCH-CodeMapping  PDSCH-CodeMapping OPTIONAL,
  -- This IE shall be present if the DSCH Information IE is present --
  powerOffsetInformation PowerOffsetInformation-RL-SetupRqstFDD,
  fdd-TPC-DownlinkStepSize FDD-TPC-DownlinkStepSize,
  limitedPowerIncrease  LimitedPowerIncrease,
  innerLoopDLPCStatus   InnerLoopDLPCStatus,
  iE-Extensions         ProtocolExtensionContainer { { DL-DPCH-Information-RL-SetupRqstFDD-ExtIEs } } OPTIONAL,
  ...
}
DL-DPCH-Information-RL-SetupRqstFDD-ExtIEs NBAP-PROTOCOL-EXTENSION ::= {
  ...
}
PowerOffsetInformation-RL-SetupRqstFDD ::= SEQUENCE {
  p01-ForTFCI-Bits    PowerOffset,
  p02-ForTPC-Bits     PowerOffset,
  p03-ForPilotBits    PowerOffset,
  iE-Extensions       ProtocolExtensionContainer { { PowerOffsetInformation-RL-SetupRqstFDD-ExtIEs } } OPTIONAL,
  ...
}
PowerOffsetInformation-RL-SetupRqstFDD-ExtIEs NBAP-PROTOCOL-EXTENSION ::= {
  ...
}
TFCI2-Bearer-Information-RL-SetupRqstFDD ::= SEQUENCE {
  toAWS               ToAWS,
  toAWE               ToAWE,
  iE-Extensions       ProtocolExtensionContainer { { TFCI2-Bearer-Information-RL-SetupRqstFDD-ExtIEs } } OPTIONAL,
  ...
}
TFCI2-Bearer-Information-RL-SetupRqstFDD-ExtIEs NBAP-PROTOCOL-EXTENSION ::= {
  { ID id-bindingID          CRITICALITY ignore  EXTENSION  BindingID          PRESENCE  optional }|
  { ID id-transportlayeraddress CRITICALITY ignore  EXTENSION  TransportLayerAddress PRESENCE  optional },
  ...
}

```

```

}

RL-InformationList-RL-SetupRqstFDD ::= SEQUENCE (SIZE (1..maxNrOfRLs)) OF
  ProtocolIE-Single-Container{{ RL-InformationItemIE-RL-SetupRqstFDD }}

RL-InformationItemIE-RL-SetupRqstFDD NBAP-PROTOCOL-IES ::= {
  { ID      id-RL-InformationItem-RL-SetupRqstFDD      CRITICALITY    notify          TYPE          RL-InformationItem-RL-SetupRqstFDD
    PRESENCE    mandatory}
}

RL-InformationItem-RL-SetupRqstFDD ::= SEQUENCE {
  rL-ID                RL-ID,
  c-ID                 C-ID,
  firstRLS-indicator   FirstRLS-Indicator,
  frameOffset          FrameOffset,
  chipOffset           ChipOffset,
  propagationDelay     PropagationDelay          OPTIONAL,
  diversityControlField DiversityControlField    OPTIONAL,
  -- This IE shall be present if the RL is not the first one in the RL Information IE
  dl-CodeInformation   FDD-DL-CodeInformation,
  initialDL-transmissionPower DL-Power,
  maximumDL-power     DL-Power,
  minimumDL-power     DL-Power,
  sSDT-Cell-Identity  SSdT-Cell-Identity          OPTIONAL,
  transmitDiversityIndicator TransmitDiversityIndicator  OPTIONAL,
  -- This IE shall be present if Diversity Mode IE in UL DPCH Information group is not set to "none"
  iE-Extensions       ProtocolExtensionContainer { { RL-InformationItem-RL-SetupRqstFDD-ExtIEs } }  OPTIONAL,
  ...
}

RL-InformationItem-RL-SetupRqstFDD-ExtIEs NBAP-PROTOCOL-EXTENSION ::= {
  { ID id-SSDT-CellIDforEDSCHPC          CRITICALITY ignore  EXTENSION SSdT-Cell-Identity          PRESENCE conditional }|
  -- This IE shall be present if Enhanced DSCH PC IE is present in the DSCH Common Information IE.
  { ID id-RL-Specific-DCH-Info          CRITICALITY ignore  EXTENSION RL-Specific-DCH-Info        PRESENCE optional }|
  { ID id-DelayedActivation             CRITICALITY reject  EXTENSION DelayedActivation           PRESENCE optional }|
  { ID id-Qth-Parameter                 CRITICALITY ignore  EXTENSION Qth-Parameter               PRESENCE optional }|
  { ID id-Primary-CPICH-Usage-for-Channel-Estimation CRITICALITY ignore  EXTENSION Primary-CPICH-Usage-for-Channel-Estimation PRESENCE optional }|
  { ID id-Secondary-CPICH-Information    CRITICALITY ignore  EXTENSION CommonPhysicalChannelID     PRESENCE optional },
  ...
}

F-DPCH-Information-RL-SetupRqstFDD ::= SEQUENCE {
  powerOffsetInformation PowerOffsetInformation-F-DPCH-RL-SetupRqstFDD,
  fdd-TPC-DownlinkStepSize FDD-TPC-DownlinkStepSize,
  limitedPowerIncrease LimitedPowerIncrease,
  innerLoopDLPCStatus InnerLoopDLPCStatus,
  iE-Extensions ProtocolExtensionContainer { { F-DPCH-Information-RL-SetupRqstFDD-ExtIEs } }  OPTIONAL,
  ...
}

F-DPCH-Information-RL-SetupRqstFDD-ExtIEs NBAP-PROTOCOL-EXTENSION ::= {
  ...
}

```

```
}  
PowerOffsetInformation-F-DPCH-RL-SetupRqstFDD ::= SEQUENCE {  
  pO2-ForTPC-Bits          PowerOffset,  
  iE-Extensions           ProtocolExtensionContainer { { PowerOffsetInformation-F-DPCH-RL-SetupRqstFDD-ExtIEs } } OPTIONAL,  
  ...  
}  
PowerOffsetInformation-F-DPCH-RL-SetupRqstFDD-ExtIEs NBAP-PROTOCOL-EXTENSION ::= {  
  ...  
}
```

UNCHANGED TEXT IS REMOVED

```

-- *****
--
-- RADIO LINK RECONFIGURATION PREPARE FDD
--
-- *****

RadioLinkReconfigurationPrepareFDD ::= SEQUENCE {
    protocolIEs          ProtocolIE-Container    {{RadioLinkReconfigurationPrepareFDD-IEs}},
    protocolExtensions   ProtocolExtensionContainer {{RadioLinkReconfigurationPrepareFDD-Extensions}}          OPTIONAL,
    ...
}

RadioLinkReconfigurationPrepareFDD-IEs NBAP-PROTOCOL-IES ::= {
    { ID id-NodeB-CommunicationContextID          CRITICALITY reject TYPE NodeB-CommunicationContextID          PRESENCE mandatory } |
    { ID id-UL-DPCH-Information-RL-ReconfPrepFDD  CRITICALITY reject TYPE UL-DPCH-Information-RL-ReconfPrepFDD PRESENCE optional } |
    { ID id-DL-DPCH-Information-RL-ReconfPrepFDD  CRITICALITY reject TYPE DL-DPCH-Information-RL-ReconfPrepFDD PRESENCE optional } |
    { ID id-FDD-DCHs-to-Modify                    CRITICALITY reject TYPE FDD-DCHs-to-Modify                    PRESENCE optional } |
    { ID id-DCHs-to-Add-FDD                       CRITICALITY reject TYPE DCH-FDD-Information                    PRESENCE optional } |
    { ID id-DCH-DeleteList-RL-ReconfPrepFDD      CRITICALITY reject TYPE DCH-DeleteList-RL-ReconfPrepFDD PRESENCE optional } |
    { ID id-DSCH-ModifyList-RL-ReconfPrepFDD     CRITICALITY reject TYPE DSCH-ModifyList-RL-ReconfPrepFDD PRESENCE optional } |
    { ID id-DSCHs-to-Add-FDD                     CRITICALITY reject TYPE DSCH-FDD-Information                    PRESENCE optional } |
    { ID id-DSCH-DeleteList-RL-ReconfPrepFDD     CRITICALITY reject TYPE DSCH-DeleteList-RL-ReconfPrepFDD PRESENCE optional } |
    { ID id-TFCI2-BearerSpecificInformation-RL-ReconfPrepFDD CRITICALITY reject TYPE TFCI2-BearerSpecificInformation-RL-ReconfPrepFDD PRESENCE optional } |
    { ID id-RL-InformationList-RL-ReconfPrepFDD  CRITICALITY reject TYPE RL-InformationList-RL-ReconfPrepFDD PRESENCE optional } |
    { ID id-Transmission-Gap-Pattern-Sequence-Information CRITICALITY reject TYPE Transmission-Gap-Pattern-Sequence-Information PRESENCE optional },
    ...
}

RadioLinkReconfigurationPrepareFDD-Extensions NBAP-PROTOCOL-EXTENSION ::= {
    { ID id-DSCH-FDD-Common-Information          CRITICALITY ignore EXTENSION DSCH-FDD-Common-Information          PRESENCE optional } |
    { ID id-SignallingBearerRequestIndicator     CRITICALITY reject EXTENSION SignallingBearerRequestIndicator     PRESENCE optional } |
    { ID id-HSDSCH-FDD-Information              CRITICALITY reject EXTENSION HSDSCH-FDD-Information              PRESENCE optional } |
    { ID id-HSDSCH-Information-to-Modify        CRITICALITY reject EXTENSION HSDSCH-Information-to-Modify        PRESENCE optional } |
    { ID id-HSDSCH-MACdFlows-to-Add            CRITICALITY reject EXTENSION HSDSCH-MACdFlows-Information          PRESENCE optional } |
    { ID id-HSDSCH-MACdFlows-to-Delete         CRITICALITY reject EXTENSION HSDSCH-MACdFlows-to-Delete         PRESENCE optional } |
    { ID id-HSDSCH-RNTI                        CRITICALITY reject EXTENSION HSDSCH-RNTI                        PRESENCE conditional } |
    -- The IE shall be present if HS-PDSCH RL ID IE is present.
    { ID id-HSPDSCH-RL-ID                       CRITICALITY reject EXTENSION RL-ID                       PRESENCE optional } |
    { ID id-F-DPCH-Information-RL-ReconfPrepFDD CRITICALITY reject EXTENSION F-DPCH-Information-RL-ReconfPrepFDD PRESENCE optional },
    ...
}

UL-DPCH-Information-RL-ReconfPrepFDD ::= SEQUENCE {
    ul-ScramblingCode          UL-ScramblingCode          OPTIONAL,
    ul-SIR-Target              UL-SIR                      OPTIONAL,
    minUL-ChannelisationCodeLength MinUL-ChannelisationCodeLength OPTIONAL,
    maxNrOfUL-DPDCHs          MaxNrOfUL-DPDCHs          OPTIONAL,
    -- This IE shall be present if minUL-ChannelisationCodeLength Ie is set to 4
    ul-PunctureLimit          PunctureLimit            OPTIONAL,
    tFCS                      TFCS                    OPTIONAL,
    ul-DPCCH-SlotFormat       UL-DPCCH-SlotFormat       OPTIONAL,

```



```

diversityMode                DiversityMode                OPTIONAL,
sSDT-CellIDLength            SSDT-CellID-Length            OPTIONAL,
s-FieldLength                S-FieldLength                OPTIONAL,
iE-Extensions                ProtocolExtensionContainer { { UL-DPCH-Information-RL-ReconfPrepFDD-ExtIEs } }  OPTIONAL,
...
}

UL-DPCH-Information-RL-ReconfPrepFDD-ExtIEs  NBAP-PROTOCOL-EXTENSION ::= {
...
}

DL-DPCH-Information-RL-ReconfPrepFDD ::= SEQUENCE {
tFCS                          TFCS                          OPTIONAL,
dl-DPCH-SlotFormat            DL-DPCH-SlotFormat            OPTIONAL,
tFCI-SignallingMode           TFCI-SignallingMode           OPTIONAL,
tFCI-Presence                 TFCI-Presence                 OPTIONAL,
-- This IE shall be present if the DL DPCH Slot Format IE is set to any of the values from 12 to 16
multiplexingPosition          MultiplexingPosition           OPTIONAL,
pDSCH-CodeMapping             PDSCH-CodeMapping             OPTIONAL,
pDSCH-RL-ID                   RL-ID                          OPTIONAL,
limitedPowerIncrease           LimitedPowerIncrease           OPTIONAL,
iE-Extensions                ProtocolExtensionContainer { { DL-DPCH-Information-RL-ReconfPrepFDD-ExtIEs } }  OPTIONAL,
...
}

DL-DPCH-Information-RL-ReconfPrepFDD-ExtIEs  NBAP-PROTOCOL-EXTENSION ::= {
{ ID id-DL-DPCH-Power-Information-RL-ReconfPrepFDD CRITICALITY reject EXTENSION DL-DPCH-Power-Information-RL-ReconfPrepFDD PRESENCE optional },
...
}

DL-DPCH-Power-Information-RL-ReconfPrepFDD ::= SEQUENCE {
powerOffsetInformation        PowerOffsetInformation-RL-ReconfPrepFDD,
fdd-TPC-DownlinkStepSize     FDD-TPC-DownlinkStepSize,
innerLoopDLPCStatus          InnerLoopDLPCStatus,
iE-Extensions                ProtocolExtensionContainer { { DL-DPCH-Power-Information-RL-ReconfPrepFDD } }  OPTIONAL,
...
}

DL-DPCH-Power-Information-RL-ReconfPrepFDD NBAP-PROTOCOL-EXTENSION ::= {
...
}

PowerOffsetInformation-RL-ReconfPrepFDD ::= SEQUENCE {
p01-ForTFCI-Bits             PowerOffset,
p02-ForTPC-Bits              PowerOffset,
p03-ForPilotBits             PowerOffset,
iE-Extensions                ProtocolExtensionContainer { { PowerOffsetInformation-RL-ReconfPrepFDD-ExtIEs } }  OPTIONAL,
...
}

PowerOffsetInformation-RL-ReconfPrepFDD-ExtIEs NBAP-PROTOCOL-EXTENSION ::= {
...
}

```

```

DCH-DeleteList-RL-ReconfPrepFDD ::= SEQUENCE (SIZE (1..maxNrOfDCHs)) OF DCH-DeleteItem-RL-ReconfPrepFDD

DCH-DeleteItem-RL-ReconfPrepFDD ::= SEQUENCE {
    dCH-ID                               DCH-ID,
    iE-Extensions                         ProtocolExtensionContainer { { DCH-DeleteItem-RL-ReconfPrepFDD-ExtIEs } } OPTIONAL,
    ...
}

DCH-DeleteItem-RL-ReconfPrepFDD-ExtIEs NBAP-PROTOCOL-EXTENSION ::= {
    ...
}

DSCH-ModifyList-RL-ReconfPrepFDD ::= SEQUENCE (SIZE (1..maxNrOfDSCHs)) OF ProtocolIE-Single-Container {{DSCH-ModifyItemIE-RL-ReconfPrepFDD }}

DSCH-ModifyItemIE-RL-ReconfPrepFDD NBAP-PROTOCOL-IES ::= {
    { ID      id-DSCH-ModifyItem-RL-ReconfPrepFDD      CRITICALITY reject      TYPE      DSCH-ModifyItem-RL-ReconfPrepFDD      PRESENCE mandatory}
}

DSCH-ModifyItem-RL-ReconfPrepFDD ::= SEQUENCE {
    dSCH-ID                               DSCH-ID,
    dl-TransportFormatSet                 TransportFormatSet          OPTIONAL,
    allocationRetentionPriority            AllocationRetentionPriority OPTIONAL,
    frameHandlingPriority                  FrameHandlingPriority       OPTIONAL,
    toAWS                                  ToAWS                       OPTIONAL,
    toAWE                                  ToAWE                       OPTIONAL,
    transportBearerRequestIndicator        TransportBearerRequestIndicator,
    iE-Extensions                         ProtocolExtensionContainer { { DSCH-ModifyItem-RL-ReconfPrepFDD-ExtIEs } } OPTIONAL,
    ...
}

DSCH-ModifyItem-RL-ReconfPrepFDD-ExtIEs NBAP-PROTOCOL-EXTENSION ::= {
    { ID      id-bindingID                       CRITICALITY ignore      EXTENSION BindingID          PRESENCE optional }|
    { ID      id-transportlayeraddress           CRITICALITY ignore      EXTENSION TransportLayerAddress PRESENCE optional },
    ...
}

DSCH-DeleteList-RL-ReconfPrepFDD ::= SEQUENCE (SIZE (1..maxNrOfDSCHs)) OF ProtocolIE-Single-Container {{DSCH-DeleteItemIE-RL-ReconfPrepFDD }}

DSCH-DeleteItemIE-RL-ReconfPrepFDD NBAP-PROTOCOL-IES ::= {
    { ID      id-DSCH-DeleteItem-RL-ReconfPrepFDD      CRITICALITY reject      TYPE      DSCH-DeleteItem-RL-ReconfPrepFDD      PRESENCE mandatory}
}

DSCH-DeleteItem-RL-ReconfPrepFDD ::= SEQUENCE {
    dSCH-ID                               DSCH-ID,
    iE-Extensions                         ProtocolExtensionContainer { { DSCH-DeleteItem-RL-ReconfPrepFDD-ExtIEs } } OPTIONAL,
    ...
}

DSCH-DeleteItem-RL-ReconfPrepFDD-ExtIEs NBAP-PROTOCOL-EXTENSION ::= {
    ...
}

```

```

TFCI2-BearerSpecificInformation-RL-ReconfPrepFDD ::= CHOICE {
  addOrModify      AddOrModify-TFCI2-RL-ReconfPrepFDD,
  delete           NULL
}

AddOrModify-TFCI2-RL-ReconfPrepFDD ::= SEQUENCE {
  toAWS            ToAWS,
  toAWE            ToAWE,
  iE-Extensions   ProtocolExtensionContainer { { AddOrModify-TFCI2-RL-ReconfPrepFDD-ExtIEs } } OPTIONAL,
  ...
}

AddOrModify-TFCI2-RL-ReconfPrepFDD-ExtIEs NBAP-PROTOCOL-EXTENSION ::= {
  { ID id-TFCI2BearerRequestIndicator CRITICALITY reject EXTENSION TFCI2BearerRequestIndicator PRESENCE optional }|
  { ID id-bindingID CRITICALITY ignore EXTENSION BindingID PRESENCE optional }|
  { ID id-transportlayeraddress CRITICALITY ignore EXTENSION TransportLayerAddress PRESENCE optional },
  ...
}

RL-InformationList-RL-ReconfPrepFDD ::= SEQUENCE (SIZE (1..maxNrOfRLs)) OF ProtocolIE-Single-Container { { RL-InformationItemIE-RL-ReconfPrepFDD } }

RL-InformationItemIE-RL-ReconfPrepFDD NBAP-PROTOCOL-IES ::= {
  { ID id-RL-InformationItem-RL-ReconfPrepFDD CRITICALITY reject TYPE RL-InformationItem-RL-ReconfPrepFDD PRESENCE mandatory }
}

RL-InformationItem-RL-ReconfPrepFDD ::= SEQUENCE {
  rL-ID RL-ID,
  dl-CodeInformation FDD-DL-CodeInformation OPTIONAL,
  maxDL-Power DL-Power OPTIONAL,
  minDL-Power DL-Power OPTIONAL,
  sSDT-Indication SSdT-Indication OPTIONAL,
  sSDT-Cell-Identity SSdT-Cell-Identity OPTIONAL,
  -- The IE shall be present if the SSdT Indication IE is set to "SSdT Active in the UE"
  transmitDiversityIndicator TransmitDiversityIndicator OPTIONAL,
  -- This IE shall be present if Diversity Mode IE is present in UL DPCH Information IE and it is not set to "none"
  iE-Extensions ProtocolExtensionContainer { { RL-InformationItem-RL-ReconfPrepFDD-ExtIEs } } OPTIONAL,
  ...
}

RL-InformationItem-RL-ReconfPrepFDD-ExtIEs NBAP-PROTOCOL-EXTENSION ::= {
  { ID id-SSdT-CellIDforEDSCHPC CRITICALITY ignore EXTENSION SSdT-Cell-Identity PRESENCE conditional }|
  -- This IE shall be present if Enhanced DSCH PC IE is present in the DSCH Common Information IE.
  { ID id-DLReferencePower CRITICALITY ignore EXTENSION DL-Power PRESENCE optional }|
  { ID id-RL-Specific-DCH-Info CRITICALITY ignore EXTENSION RL-Specific-DCH-Info PRESENCE optional }|
  { ID id-DL-DPCH-TimingAdjustment CRITICALITY reject EXTENSION DL-DPCH-TimingAdjustment PRESENCE optional }|
  { ID id-Qth-Parameter CRITICALITY ignore EXTENSION Qth-Parameter PRESENCE optional }|
  { ID id-Primary-CPICH-Usage-for-Channel-Estimation CRITICALITY ignore EXTENSION Primary-CPICH-Usage-for-Channel-Estimation PRESENCE optional }|
  { ID id-Secondary-CPICH-Information-Change CRITICALITY ignore EXTENSION Secondary-CPICH-Information-Change PRESENCE optional },
  ...
}

```

```

F-DPCH-Information-RL-ReconfPrepFDD ::= SEQUENCE {
    powerOffsetInformation          PowerOffsetInformation-F-DPCH-RL-ReconfPrepFDD,
    fdd-TPC-DownlinkStepSize      FDD-TPC-DownlinkStepSize,
    limitedPowerIncrease          LimitedPowerIncrease,
    innerLoopDLPCStatus          InnerLoopDLPCStatus,
    iE-Extensions                 ProtocolExtensionContainer { { F-DPCH-Information-RL-ReconfPrepFDD-ExtIEs } } OPTIONAL,
    ...
}

```

```

F-DPCH-Information-RL-ReconfPrepFDD-ExtIEs NBAP-PROTOCOL-EXTENSION ::= {
    ...
}

```

```

PowerOffsetInformation-F-DPCH-RL-ReconfPrepFDD ::= SEQUENCE {
    pO2-ForTPC-Bits              PowerOffset,
    iE-Extensions                 ProtocolExtensionContainer { { PowerOffsetInformation-F-DPCH-RL-ReconfPrepFDD-ExtIEs } } OPTIONAL,
    ...
}

```

```

PowerOffsetInformation-F-DPCH-RL-ReconfPrepFDD-ExtIEs NBAP-PROTOCOL-EXTENSION ::= {
    ...
}

```

UNCHANGED TEXT IS REMOVED

## 9.3.4 Information Elements Definitions

```

--*****
--
-- Information Element Definitions
--
--*****

```

```

NBAP-IEs {
itu-t (0) identified-organization (4) etsi (0) mobileDomain (0)
umts-Access (20) modules (3) nbap (2) version1 (1) nbap-IEs (2) }

```

```

DEFINITIONS AUTOMATIC TAGS ::=
BEGIN

```

**UNCHANGED TEXT IS REMOVED**

```

Cause ::= CHOICE {
    radioNetwork      CauseRadioNetwork,
    transport         CauseTransport,
    protocol          CauseProtocol,
    misc              CauseMisc,
    ...
}

CauseMisc ::= ENUMERATED {
    control-processing-overload,
    hardware-failure,
    oam-intervention,
    not-enough-user-plane-processing-resources,
    unspecified,
    ...
}

CauseProtocol ::= ENUMERATED {
    transfer-syntax-error,
    abstract-syntax-error-reject,
    abstract-syntax-error-ignore-and-notify,
    message-not-compatible-with-receiver-state,
    semantic-error,
    unspecified,
    abstract-syntax-error-falsely-constructed-message,
    ...
}

CauseRadioNetwork ::= ENUMERATED {
    unknown-C-ID,
    cell-not-available,
    power-level-not-supported,
    dl-radio-resources-not-available,
    ul-radio-resources-not-available,
    rl-already-ActivatedOrAllocated,

```

```

nodeB-Resources-unavailable,
measurement-not-supported-for-the-object,
combining-resources-not-available,
requested-configuration-not-supported,
synchronisation-failure,
priority-transport-channel-established,
SIB-Origination-in-Node-B-not-Supported,
requested-tx-diversity-mode-not-supported,
unspecified,
bCCH-scheduling-error,
measurement-temporarily-not-available,
invalid-CM-settings,
reconfiguration-CFN-not-elapsed,
number-of-DL-codes-not-supported,
s-cipch-not-supported,
combining-not-supported,
ul-sf-not-supported,
dl-SF-not-supported,
common-transport-channel-type-not-supported,
dedicated-transport-channel-type-not-supported,
downlink-shared-channel-type-not-supported,
uplink-shared-channel-type-not-supported,
cm-not-supported,
tx-diversity-no-longer-supported,
unknown-Local-Cell-ID,
...,
number-of-UL-codes-not-supported,
information-temporarily-not-available,
information-provision-not-supported-for-the-object,
cell-synchronisation-not-supported,
cell-synchronisation-adjustment-not-supported,
dpc-mode-change-not-supported,
iPDL-already-activated,
iPDL-not-supported,
iPDL-parameters-not-available,
frequency-acquisition-not-supported,
power-balancing-status-not-compatible,
requested-typeofbearer-re-arrangement-not-supported,
signalling-Bearer-Re-arrangement-not-supported,
bearer-Re-arrangement-needed,
delayed-activation-not-supported,
rl-timing-adjustment-not-supported,
mich-not-supported,
harq-preamble-mode-not-supported,
f-DPCH-not-supported
}

CauseTransport ::= ENUMERATED {
    transport-resource-unavailable,
    unspecified,
    ...
}

```

UNCHANGED TEXT IS REMOVED

### 9.3.6 Constant Definitions

```
-- *****
--
-- Constant definitions
--
-- *****

NBAP-Constants {
itu-t (0) identified-organization (4) etsi (0) mobileDomain (0)
umts-Access (20) modules (3) nbap (2) version1 (1) nbap-Constants (4)}
```

DEFINITIONS AUTOMATIC TAGS ::=

BEGIN

UNCHANGED TEXT IS REMOVED

```
-- *****
--
-- IEs
--
-- *****
```

UNCHANGED TEXT IS REMOVED

id-Tstd-indicator	ProtocolIE-ID ::= 627
id-multiple-RL-Information-RL-ReconfPrepTDD	ProtocolIE-ID ::= 628
id-multiple-RL-Information-RL-ReconfRqstTDD	ProtocolIE-ID ::= 629
<a href="#">id-DL-DPCH-Power-Information-RL-ReconfPrepFDD</a>	<a href="#">ProtocolIE-ID ::= 630</a>
<a href="#">id-F-DPCH-Information-RL-ReconfPrepFDD</a>	<a href="#">ProtocolIE-ID ::= 631</a>
<a href="#">id-F-DPCH-Information-RL-SetupRqstFDD</a>	<a href="#">ProtocolIE-ID ::= 632</a>
id-Additional-S-CCPCH-Parameters-CTCH-ReconfRqstTDD	ProtocolIE-ID ::= 633
id-Additional-S-CCPCH-Parameters-CTCH-SetupRqstTDD	ProtocolIE-ID ::= 634
id-Additional-S-CCPCH-LCR-Parameters-CTCH-ReconfRqstTDD	ProtocolIE-ID ::= 635
id-Additional-S-CCPCH-LCR-Parameters-CTCH-SetupRqstTDD	ProtocolIE-ID ::= 636
id-MICH-CFN	ProtocolIE-ID ::= 637
id-MICH-Information-AuditRsp	ProtocolIE-ID ::= 638
id-MICH-Information-ResourceStatusInd	ProtocolIE-ID ::= 639
id-MICH-Parameters-CTCH-ReconfRqstFDD	ProtocolIE-ID ::= 640
id-MICH-Parameters-CTCH-ReconfRqstTDD	ProtocolIE-ID ::= 641
id-MICH-Parameters-CTCH-SetupRqstFDD	ProtocolIE-ID ::= 642
id-MICH-Parameters-CTCH-SetupRqstTDD	ProtocolIE-ID ::= 643
id-Modification-Period	ProtocolIE-ID ::= 644
id-NI-Information-NotifUpdateCmd	ProtocolIE-ID ::= 645
id-S-CCPCH-InformationListExt-AuditRsp	ProtocolIE-ID ::= 646
id-S-CCPCH-InformationListExt-ResourceStatusInd	ProtocolIE-ID ::= 647
id-S-CCPCH-LCR-InformationListExt-AuditRsp	ProtocolIE-ID ::= 648
id-S-CCPCH-LCR-InformationListExt-ResourceStatusInd	ProtocolIE-ID ::= 649
id-HARQ-Preamble-Mode	ProtocolIE-ID ::= 650

END