Source: ETSI TC-SMG

Key words: Digital cellular telecommunications system, Global System for Mobile communications (GSM)



**Digital cellular telecommunications system;
GSM Electro Magnetic Compatibility (EMC) considerations
(GSM 05.90 version 6.0.0)**

ETSI

European Telecommunications Standards Institute

ETSI Secretariat

Postal address: F-06921 Sophia Antipolis CEDEX - FRANCE

Office address: 650 Route des Lucioles - Sophia Antipolis - Valbonne - FRANCE

X.400: c=fr, a=atlas, p=etsi, s=secretariat - **Internet:** secretariat@etsi.fr

Tel.: +33 4 92 94 42 00 - Fax: +33 4 93 65 47 16

Copyright Notification: No part may be reproduced except as authorized by written permission. The copyright and the foregoing restriction extend to reproduction in all media.

© European Telecommunications Standards Institute 1998. All rights reserved.

Contents

Foreword.....	4
1 Scope.....	6
1.2 References.....	7
2 Information available	7
3 Cause of potential EMC interference.....	8
4 Laboratory results.....	8
4.1 Hearing aids	8
4.2 Cardiac pace-makers.....	9
4.3 Domestic equipment	10
5 Modelling results.....	10
6 Solutions	11
7 Non-ionizing radiation.....	11
8 Conclusion	11
9 Other EMC reports.....	12
Annex A: A GSM interference model.....	13
Annex B: GSM - Hearing aid interference modelling parameters.....	30
Annex C: New digital transmission technologies - the EMC conundrum.....	33
Annex D: Potential GSM hazards on cardiac pacemakers.....	37
Annex E: Summary document on GSM-TDMA interference	43
Annex F: Interference to hearing aids by the new digital mobile telephone system, Global System for Mobile (GSM) communications standard	51
Annex G: Studies on interference from GSM terminals to the fixed network telephone equipment.....	68
History.....	107

Blank Page

Foreword

This GSM Technical Specification (GTS) has been produced by the Special Mobile Group (SMG) Technical Committee (TC) of the European Telecommunications Standards Institute (ETSI).

This GTS summarizes the work which has been conducted, mainly in the UK, to investigate the effect of wanted radio frequency transmissions from GSM Mobile Stations (MS) and Base Transceiver Stations (BTS) within the digital cellular telecommunications system on other equipment.

Blank Page

1 Scope

A considerable amount of work has been conducted, mainly in the UK, to investigate the effect of wanted radio frequency transmissions from GSM MS and BTS on other equipment. This report aims to summarize this work and to look at the implications for GSM. Since GSM EMC considerations extend outside the GSM arena, it is thought essential that GSM considers the implications of EMC and produces this report.

1.2 References

This GTS incorporates by dated and undated reference, provisions from other publications. These normative references are cited at the appropriate places in the text and the publications are listed hereafter. For dated references, subsequent amendments to or revisions of any of these publications apply to this GTS only when incorporated in it by amendment or revision. For undated references, the latest edition of the publication referred to applies.

- [1] 89/336/EEC: "Council Directive on the approximation of the laws of the Member States relating to electromagnetic compatibility".
- [2] EN 50082-1 (1992): "Electromagnetic compatibility - Generic immunity standard. Part 1: Residential, commercial and light industry".
- [3] IEC 801-3, (1984): "Immunity to radiated, radio frequency, electromagnetic fields".
- [4] GSM 01.04 (ETR 350): "Digital cellular telecommunications system (Phase 2+); Abbreviations and acronyms".
- [5] DTI/RA: "A summarized report on measurement techniques used to investigate potential interference from new digital systems".
- [6] INIRC (1988): "Guidelines on limits of exposure to radiofrequency electromagnetic fields in the frequency range 100 kHz to 300 GHz".
- [7] NRPB (1989): "Guidance as to restrictions on exposures to time varying electromagnetic fields and the 1988 recommendations of the International Non-Ionizing Radiation Committee".
- [8] IEEE C95.1 (1991): "IEEE standard for safety levels with respect to human exposure to radio frequency electromagnetic fields, 4 kHz to 300 GHz".
- [9] Draft DIN VDE 0848 Part 2 (1991): "Safety in electromagnetic fields; protection of persons in the frequency range from 30 kHz to 300 GHz".
- [10] CENELEC European prestandard ENV50166-2 (January 1995): "Human exposure to electromagnetic fields ,High Frequency (10 kHz to 300 GHz)".

2 Information available

A number of European organizations have conducted extensive investigations into GSM EMC. These investigations looked at the potential of a GSM transmission to interfere with a wide range of electrical apparatus. Having conducted both objective and subjective investigations, it was discovered that personal audio equipment (e.g. Walkmans) and hearing aids were most susceptible and most likely to be in close proximity to GSM apparatus.

Of these two types of apparatus, hearing aids were considered the greatest potential problem and thus a considerable amount of modelling work was conducted in order to assess the likely incidence of interference in various scenarios.

Interference with pace-makers was considered of utmost seriousness and consequently tests were made to investigate the possibility of interfering with certain types.

3 Cause of potential EMC interference

The source of GSM interference is the 100 % amplitude modulated RF envelope introduced by burst transmission necessary for Time Division multiple Access (TDMA). Audio apparatus having some non-linear component able to demodulate this Amplitude Modulation (AM) envelope will be subject to interference in the audio pass-band since the frame and burst rates for GSM are 220 Hz and 1,7 kHz.

Another source of interference is the DTX (Discontinuous Transmission) mode of operation in GSM. In the DTX mode there are two signal components with much lower frequencies than the normal GSM transmission: a component with a frequency of 2.1 Hz corresponding to the transmission of the 8 timeslots of the SID (Signal Descriptor) message block, and another with a frequency of 8,3 Hz corresponding to the repetition rate of SACCH.

4 Laboratory results

4.1 Hearing aids

Objective laboratory results from the United Kingdom, Department of Trade and Industry, Radiocommunications Agency (DTI/RA) [5] showed that a typical "behind the ear" hearing aid in normal (amplifying) mode was susceptible to peak GSM field intensities of;

- between 10 V/m and 17 V/m in order to produce the same audio power as speech, 0.5 m in front of the hearing aid; and
- between 5 V/m and 8.5 V/m to produce "audible, slightly annoying" interference.

It was noted that the group of hearing aids tested showed a 4 dB spread in susceptibility in the normal mode and a 13 dB spread in susceptibility in the inductive loop mode.

Subjective investigation conducted at BTRL with the hearing aid worn by the user showed that "audible, slightly annoying" interference was perceived when subject to a peak field intensity varying between 10 V/m and 4 V/m depending upon the orientation of the head. This was modelled by a peak field intensity of 10 V/m for a 270° arc and 4 V/m for the 90° arc not shielded by the head inferring an 8 dB attenuation provided by the head. This directional susceptibility corresponds to an average of 6.6 V/m and thus agrees with the DTI/RA objective results.

These results were subsequently used for modelling activities to assess the consequences of this susceptibility in various scenarios. It should be noted that the susceptibility without head attenuation used in the model (4 V/m) is somewhat worse than the DTI measurements (5 V/m - 8.5 V/m) and thus the modelling results will be very much worst case.

It was found that metallising the hearing aid case reduced the susceptibility with no head attenuation from 4 V/m to 12 V/m (10 dB).

Laboratory measurements have been carried out also in Australia by Telecom Research Laboratories and National Acoustic Laboratories (annex F). In these measurements the field strength level causing useful "annoyance" threshold level of 10 dB above the noise floor of the hearing aids was measured and then compared to measured field strength of 2 W and 8 W GSM MS to determine the distances where the threshold levels can be expected. Both behind-the-ear and in-the-ear type hearing aids were measured, the former ones both with microphone input and telecoil input. The results are shown below.

Table 1. Field strength and safety distances for noticeable interference

Hearing aid type	Field strength for noticeable interference	Distance for noticeable interference	
		2 W MS	8 W MS
Behind the ear, microphone input	0.7 - 3.1 V/m	2.0 - 10 m	3.5 - 20 m
Behind the ear, telecoil input	0.4 - 4.9 V/m	1.5 - 20 m	2.5 - 40 m
In the ear	4.9 - 32.3 V/m	0.2 - 0.6 m	0.4 - 1.5 m

NOTE: The distances in table 1 can not be compared directly with those in table 2 because table 1 distances are approximate real-life distances whereas table 2 is based on theory.

In Denmark a study initiated by the Danish ministry of communications has been carried out recently. The results of the study are in a report "Interference to hearing aids caused by GSM mobile telephones". Following are the main conclusions of the report:

- so far there have not been many actual examples of interference but it must be foreseen that in 3 - 4 years there will be frequent reports of interference to hearing aids occasioned by GSM mobiles;
- it is anticipated that existing hearing aids will be replaced by new models with generally greater immunity to GSM signals; in any event, in 5 - 7 years the risk of interference should have diminished significantly;
- solutions to decrease the amount of interference based on GSM system will either have a highly limited effect (transmitter power regulation) or will be financially unfeasible (cell size optimization);
- solutions based on design changes to hearing aids will generally be possible and must offer immunity against signal strengths of up to 10 V/m; some hearing aids used today already satisfy requirements and future models will be able to be so constructed as to meet them too; designing a new hearing aid with the requisite level of immunity would increase prices approx. DKK 100 per unit, which is a 4 - 7 % increase to a current price of a hearing aid.

4.2 Cardiac pace-makers

Work was carried out by CSELT Italy to investigate the effects of GSM type burst structure on cardiac pace-makers (annex D). Unipolar and bipolar types from one manufacturer were tested. The results show that, although it was possible to interfere with pace-maker operation in free space, it was not possible, with the equipment power used, to interfere with operation when the pace-maker, leads and electrodes were placed in a phantom simulating realistic use in the human body. The equivalent maximum field strength used for this test would not normally be exceeded at further than 0.5 m away from any allowed GSM transmitter except the maximum power base station. For information the field strength required to defeat the pace-maker in free space was in excess of 40 V/m for the most sensitive class of pace-maker.

As there does not appear to be a problem with defeating of pace-maker operation by a normal GSM signal, the remainder of the work done by GSM, and thus the remainder of this report, is restricted to scenarios for audible interference with hearing aids.

4.3 Domestic equipment

Tests carried out by various laboratories and collected together by the Radio Technology Laboratory (RTL) of the Radiocommunications Agency (annex E) show that for a limited number of devices under test the cassette decks, television receivers and portable radios/cassette players etc. are the most susceptible domestic equipment with the mean field intensities causing "visible/audible, but not annoying" interference being 2.9, 4.0, and 5.6 V/m, respectively. For example for 8 W MS the field strength of 4 V/m will be found at distances less than 5 m (worst case assuming 100 % efficiency and free space path loss) as can be seen in table 1.

This means that in practice, due to building attenuation etc., interference will not occur unless the transmitter and the victim equipment are in the same room. This is likely to occur if the GSM terminal is transportable (8 W output power for instance).

Studies on the GSM interference to the fixed network telephone equipment have been carried out in France, Norway, U.K. and Italy (annex G). All the studies highlight the fact that due to the lack of an international immunity standard to the fixed network telephone equipment the interference problem varies from country to country depending on the national immunity standards. The study carried out in France summarizes that no telephone analogue equipment or audio terminal can comply with a 10 V/m GSM type field strength, and half of the telephone sets tested did comply with the 3 V/m immunity level, both results derived with a selected performance criteria of -50 dBmop/600 Ohms in transmit direction and 50 dBA on receive direction. Regarding the maximum distances for potential interference the study gives the distances of 10 metres for 8 W GSM terminal and 5 metres for 2 W GSM terminal. The U.K. study tests the fixed network telephones and PBX equipment at 3 V/m and 10 V/m field strengths and concludes that in the U.K. the vast majority of telephones and telephone equipment is not susceptible at even 10 V/m. Hence, due to the immunity standard for fixed telephones the interference from GSM terminals is not considered as a major problem in U.K. In the Norwegian study it is summarized that with a 40 dB S/N ratio as a quality limit and with 10 W GSM transmitter 10 m away from a telephone, half of the telephones tested pass the test. Also, the study highlights the very large difference in the immunities of the fixed telephones, the immunities calculated in field strength being from 12.3 V/m to 0.6 V/m, with the same quality limit of 40 dB S/N ratio. The Italian study uses the same pass criteria as the French one and concludes that out of the tested fixed telephones, only an RF-shielded model and another with a very compact structure resulted complying with immunity requirements up to 6 V/m GSM field strength (that is 0.8 W GSM emission at 1 m distance), while some models did not even comply with 3 V/m (i.e. 0.8 W GSM emission at 2 m distance).

5 Modelling results

A wide range of scenarios were modelled (annexes A and B) to include the possible interference to hearing aid users from base stations, mobiles and handportables. Not surprisingly, by far the highest incidence of interference was caused in crowded urban environments where hearing aids and handportable transceivers are likely to be in closest proximity.

It was found that a hearing aid user would experience 3 seconds of interference every 8 minutes whilst walking on a London street and would be subject to a 2.4 % probability of interference whilst travelling on a commuter train for a GSM system occupying 2 x 25 MHz. Further results showed that with 1 % of the train passengers using GSM transmitters (0.1 % previously) and an average susceptibility of 4 V/m, the probability of interference was 5 %. These modelling results were based on a small sample of hearing aids with immunities in the region of 3 V/m. More recent measurements have shown that some hearing aids, in particular the in-the-ear aids, have immunities up to 30 V/m (see annex F). This would reduce these probabilities by a factor of 100.

It should be noted that the modelling work is based on free space path losses. The effect of, for example, people in a crowded train has not been measured, but in general it is expected that the presence of people or objects between the MS and the hearing aid will be to reduce the interference in most cases.

It should be noted that all the scenarios examined assumed the hearing aid was active all the time. Clearly, there will be instances where the user will switch off the aid when not required to communicate.

A further modelling exercise indicated that it was unlikely that a hearing aid user will be able to use GSM handportable terminals due to the interference effects.

6 Solutions

The generic immunity standard, EN 50082-1, produced by CENELEC, calls for immunity to RF electromagnetic fields of 3 V/m. This work has shown that current hearing aids have immunities close to this proposed level and that a handportable GSM transmitter is likely to present a field strength greater than this at regular intervals in a crowded environment and thus cause interference to the hearing aid user (annex C). The actual field strength from a dipole, as calculated from IEC 801-3:1984, is shown in table 2 (the values are independent of frequency).

Table 2: Close proximity field strengths

Peak transmit power (Watts)	GSM MS power class	Peak field strength (V/m)		
		1m	2m	5m
0.8	5	6.3	3.1	1.3
2	4	9.9	5.0	2.0
5	3	15.7	7.8	3.1
8	2	19.8	9.9	4.0
	DCS 1 800 MS power class			
0.25	2	3.5	1.8	0.7
1	1	7.0	3.5	1.4

A solution to this potential problem could be achieved by a combination of increased hearing aid immunity and constraints placed on the GSM system in urban environments.

Due to the likely peak field strengths that will be experienced from GSM transmitters in crowded urban areas, it is proposed that the immunity of future body worn apparatus, such as hearing aids, should be increased to 10 V/m since this has been found to significantly reduce the probability of GSM interference (this 10 V/m figure is derived from considerations of frequencies around 900 MHz and may not be applicable to frequencies significantly higher or lower than 900 MHz). Further to this, a number of simple constraints for urban GSM system design should be adhered to:-

- dynamic power control to be implemented at the MS such that only the minimum required transmit power is used at all times (BS interference was shown not to be a problem);
- urban cell sizes limited to reduce required transmit powers;
- discontinuous transmission (DTX) to be implemented where possible;
- GSM base site and mobile pay phone (e.g. on train) transmit antennas should not be located in close proximity to electrical apparatus likely to be susceptible to this type of interference.

It is assumed that DTX will provide a reduced interference potential although this has not been verified.

7 Non-ionizing radiation

Guideline levels for exposure to non-ionizing RF radiation have been published by many organizations including Non-Ionizing Radio Committee (INIRC), the UK National Radiological Protection Board (NRPB), the Institute of Electrical and Electronics Engineers (IEEE), German Electrotechnical Commission of DIN and VDE (DKE) and CENELEC. reference to these standards are given in reference [6] to [10].

8 Conclusion

Extensive research has highlighted a potential compatibility problem between GSM transmitters and body worn audio apparatus; in particular hearing aids. However, this research has been based on a limited sample of hearing aid types of fairly old design.

An increased immunity for future body worn apparatus, enforced through the Community's EMC Directive (89/336/EEC), combined with some urban cellular design constraints aimed at ensuring the minimum

transmit power is employed should ensure incidences of interference from GSM apparatus is kept to a minimum.

The studies made have shown that the immunity level of currently available hearing aids may not protect hearing aids very well from the interference of GSM phones. Also, it has been shown that increasing the immunity to 10 V/m, as found possible by simple hearing aid modification, will reduce the probability of interference considerably. More recent research has shown some modern hearing aids to have 10 times the immunity of the older designs (in V/m). This would reduce the interference probabilities by a factor of 100.

Concerning the domestic equipments it can be concluded that GSM transportable 8 W mobile stations are likely to cause problems to domestic equipment being used in a domestic environment.

Further, it is recommended that the user's data (like user's manual) of the mobile should include a warning of the possible interference effects of the GSM mobile to the other electronic equipments.

9 Other EMC reports

- | | |
|--------------------|--|
| CEPT-SE report | "Summary document on the interference to radio and non-radio devices from TDMA-type transmissions".
The report from CEPT covers much of the work included in the GSM report and considers EMC susceptibility of a far greater range of products. The findings of the two reports are similar. |
| CEPT-SE report | "Draft report from the ERC within CEPT on the impact from ISM emissions on mobile radio services operating in the 900 MHz band".
This report studies the potential for interference on GSM and other terminal equipment operating in the 900 MHz band caused by ISM equipment (Industrial, Scientific and Medical). It shows that spurious emissions from ISM equipment can degrade mobile radio service coverage at considerable distances. |
| ETS 300 342-1 to 3 | "Radio Equipment and Systems (RES); ElectroMagnetic Compatibility (EMC) for European digital cellular telecommunications system (GSM 900 MHz and DCS 1 800 MHz)".
This standard defines performance requirements for radio communication equipment to meet the Community directive 89/336/EEC. It contains requirements for GSM terminal equipment but does not address the potential of interference with other electronic equipment such as hearing aids and cardiac pace-makers. |

Annex A: A GSM interference model**A GSM interference model.****22nd February 1990****Jon Short
Cellular Radio Systems
BT Laboratories
0473 643954****Summary.**

This document attempts to forecast the likely extent of interference to hearing aid users from GSM transmitters.

The assessment is made through modelling of the GSM cellular system in various scenarios as the system matures from 1991 onwards. The potential interference in the individual scenarios is combined to assess the actual interference perceived by through modelling of 'days in the life of' hearing aid users.

The critical inputs to the model are the hearing aid immunities as determined during extensive laboratory testing.

The report concludes that a hearing aid user will experience regular daily interference from GSM transmissions and this has been previously shown to be due to the TDMA nature of the system.

Contents

- 1) Introduction**
- 2) Assumptions**
- 3) Cell Characterization**
 - 3.1) RF Link Budget
 - 3.2) Minimum MS transmit power
 - 3.3) Affected area
 - 3.4) Spectrum allocation
 - 3.5) Overall probability
- 4) Scenarios**
 - 4.1) Vehicle mounted MS
 - 4.1.1) Vehicles and pedestrians
 - 4.1.2) Trains
 - 4.2) Bases
 - 4.2.1) Low sites
 - 4.2.2) High sites
 - 4.2.3) Building coverage
 - 4.3) Portable and transportable MS
 - 4.3.1) Railway Station
 - 4.3.2) Office
 - 4.3.3) Street
 - 4.3.4) Train
- 5) 'A day in the life of' scenarios**
 - 5.1) Daily commuter from outside London
 - 5.2) Person working and dwelling in London
 - 5.3) Retired person
 - 5.4) Motorway traffic jam
- 6) Discussion**
 - 6.1) GSM Customers with Hearing Aids.
 - 6.1.1) Hand - Portables
 - 6.1.2) Transportables
 - 6.1.3) Mobiles
 - 6.2) Solutions
 - 6.3) Other interferences
 - 6.4) Possible variables
- 7) Conclusions**
- 8) References**

1) Introduction.

Having completed extensive hearing aid immunity testing [Ref. 5, 8] with simulated GSM transmission, it was necessary to assess the likely impact of the laboratory results on hearing aid users.

The key results taken from these laboratory investigations were that the hearing aids tested gave rise to 'perceptible' interference when subject to a field strength of 4V/m in some directions.

A typical urban cell is characterized using an RF link budget and a number of necessary assumptions. The salient assumptions used in this paper are listed in section 2 with local assumptions contained in individual scenario's.

Having characterized the cell, individual scenario's within the cell where hearing aid users may come in contact with GSM transmitters were chosen. A conclusion is drawn from the individual scenario's which highlights those likely to have the highest incidence of interference.

Having arrived at a model covering separate scenario's, it was necessary to combine these to build a 'day in the life of a hearing aid user. Four typical 'days' were chosen and illustrate the incidence of interference with respect to the hearing aid user.

Subsequent discussion covers GSM subscribers who use hearing aids, possible solutions and other interferences to hearing aids.

It will be noted that this document has been compiled from Refs. 10,11 and 12 with modifications agreed at the coordination meetings of 4/12/89 and 15/1/90 held at the DTI.

2) Assumptions.

- i) A central London base site has a 2km radius and a base station in power class 4 (40W).
- ii) All cells are operating at 50% capacity.
- iii) Vehicle mounted transceivers have power control to sustain at least 10^2 uplink BER.
- iv) Transportables are in power class 2 (8W) and portables in power class 4 (2W) with antennas having 0dBi gain.
- v) Subscribers will be evenly distributed between vehicle mounted transceivers and portables/ transportables.
- vi) People are evenly distributed in the cell.
- vii) Vehicle mounted transceivers are located on three concentric rings within the cell and are distributed in the ratio of their distance from the BS.
- viii) The number of hearing aids in the UK is 1.5 million (DHSS estimate 1 to 2 million) i.e 2.5% of the UK population.
- ix) The mean duration of a call is 2 minutes.

3) Cell characterization.

3.1) RF link budget.

This budget is based on GSM Recommendation 03.30.

Rx RF input sensitivity = NF (dB) + Ec/No (dB) + W - kT @ BS for 10^{-2} BER (dBm)

Where thermal noise, $kT = -174$ dBm/Hz @ 290K
 W (bit rate) = $10 \log 270.833$ kbit/s
 NF (noise figure) = 8dB
 $Ec/No = 8$ dB

Therefore, Rx RF input sensitivity @ BS = -104dBm.

Isotropic power = Rx sensitivity + Interference margin + Cable loss - Antenna Gain

Where interference margin = 3dB
 cable loss = 4dB
 antenna gain = 12dBi

Therefore, Isotropic power = -109dBm

Allowing for lognormal (5dB) and Rayleigh fading (10dB) margins gives

Minimum signal level for 10^{-2} BER = -94dBm.

3.2) Minimum MS transmit powers.

The required power to be radiated from a mobile station to maintain a 10^{-2} uplink BER may be found after characterization of the propagation path loss.

A typical central London cell is 2km in radius and has a BS located 2m above the roof of a tall building. This building will be located in a dense urban environment and of similar height to its surroundings (60m). Assuming a receive antenna height of 2m and a frequency of 900MHz, the path loss may be found from equation 3.25 in Ref.7

$$L_{\text{path}} = 69.55 + 26.16 \log f - 13.82 \log h_t - A(h_r) + (44.9 - 6.55 \log h_r) \log d_{\text{path}} \quad (\text{dB})$$

where f - frequency in MHz (900)
 h_t - transmit antenna height (62m)
 d_{path} - distance from BS in km

and from equation 3.27 in Ref.7

$$A(h_r) = 3.2(\log(11.75 h_r))^2 - 4.97 \quad (\text{dB})$$

h_r - receive antenna height (2m)

These equations thus simplify to

$$L_{\text{path}} = 121 + 33 \log d_{\text{path}} \quad (\text{dB})$$

Such a cell may thus be characterized by a 1km intercept of 121dB and a path loss of slope $\gamma=3.3$. Hence the minimum transmit power needed from the MS to maintain a 10^{-2} BER will be

$$\begin{aligned} 121-94 &= 27\text{dBm @ 1km (500mW)} \\ 27+33\log 1.5 &= 32.8\text{dBm @ 1.5km (1.9W)} \\ 27+33\log 2 &= 36.9\text{dBm @ 2km (4.9W)} \end{aligned}$$

all powers quoted being ERP at MS.

3.3) Affected area.

Equation for interfering distance, d_{int} ,

$$S = \frac{E^2}{120\pi} \quad \text{and} \quad S = \frac{G P_t}{4\pi d_{int}^2} \quad \text{where } S = \text{power density}$$

$$\qquad\qquad\qquad \qquad\qquad\qquad\qquad E = \text{field strength}$$

$$\text{Therefore, } d_{int}^2 = \frac{G 30 P_t}{E^2}$$

However, since path loss calculation leads to ERP from the mobile station then the antenna gain term, G , is redundant. i.e $G = 1$.

It was found, during interference tests [Ref.5], that a realistic hearing aid susceptibility was 4 V/m for a 90 degree arc and 10 V/m for the remaining 270 degrees as shown in Fig.1.

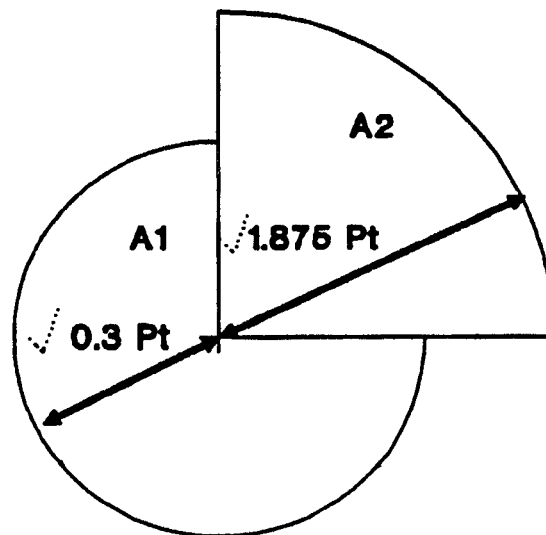

Fig.1

Let interference radius at 4 V/m be d_4 and at 10 V/m d_{10} then

$$d_4^2 = \frac{30 P_t}{16} = 1.875 P_t \quad \text{and}$$

$$d_{10}^2 = \frac{30 P_1}{100} = 0.3 P_1 \quad \text{as shown in Fig.1}$$

$$\begin{aligned} \text{Therefore, } A_1 &= \frac{\pi d_1^2}{4} \\ &= 1.47 P_1 \end{aligned}$$

$$\begin{aligned} \text{and } A_2 &= \frac{3\pi d_{10}^2}{4} \\ &= 0.71 P_1 \quad \text{as shown in Fig.1} \end{aligned}$$

$$\begin{aligned} \text{Therefore, } A_{\text{tot}} &= A_1 + A_2 \\ &= 2.18 P_1 \quad \text{Eq. 1} \end{aligned}$$

3.4) Spectrum allocation.

The GSM system will probably operate with 3 base sites per cluster and therefore, even if sectorization is employed, the entire spectrum allocation will be used repeatedly by groups of these base sites. It has been assumed that each base site (BS) covers a circular area of radius 2km.

The GSM system will begin in 1991 with an initial duplex spectrum allocation of 5MHz per operator above the current TACS bands. This allows 25 200kHz carriers and thus 25/3=8 carriers per BS and 8 x 8 time slots = 64 physical channels per BS per operator.

Assuming that there will be no more than 8 of these time slots unavailable for traffic, then 56 physical channels remain giving a maximum of 112 subscribers.

As the GSM system matures, the current TACS allocation will be gradually handed over until GSM occupies the entire 25MHz cellular allocation. Each operator will therefore have 12.5MHz or 62 200kHz carriers and thus 62/3=21 carriers per base site. This number of carriers allows 21x8=168 physical channels and thus 160 available for traffic per operator and 320 in total.

3.5) Overall probability.

It was found that a good approximation to even distribution of MS's could be attained by assuming the transmitters were located on three concentric rings and distributed in the ratio of their distance from the BS. Two rings proved to be inaccurate with four giving little change in the result obtained with three.

Using a 10MHz allocation and full cell capacity gives the following result :

$$112 \times \frac{1}{4.5} = 25 \text{ MS @ 1km}$$

$$112 \times \frac{1.5}{4.5} = 37 \text{ MS @ 1.5km}$$

$$112 \times \frac{2}{4.5} = 50 \text{ MS @ 2km}$$

The affected area around each transmitter from equation 1 is :

$$\begin{aligned}2.18 \times 0.5 &= 1.1\text{m}^2 \\2.18 \times 1.9 &= 4.1\text{m}^2 \\2.18 \times 4.9 &= 10.7\text{m}^2\end{aligned}$$

Giving a total affected area from MS's of $25 \times 1.1 + 37 \times 4.1 + 50 \times 10.7 = 714.2\text{m}^2$. Assuming the BS is power class 4 (40W) then, from equation 1 there will be a further affected area of 87.2m^2 around the BS giving a total of 801.4m^2 .

Since the area of the 2km cell is $\pi(2000)^2 = 1.26 \times 10^7\text{m}^2$ then the percentage affected area is

$$\frac{801.4}{1.26 \times 10^7} = 0.0064\%$$

Substituting figures for a fully loaded 25MHz system yields a total affected area of 2123.4m^2 or 0.017%.

As yet, however, we have no information concerning the frequency and duration of this interference.

4 Scenarios.

4.1) Vehicle mounted MS.

4.1.1) Vehicles and pedestrians.

A mobile on the edge of the 2km cell has been shown to be transmitting 4.9W giving rise to an affected area of 10.7m^2 and hence a mean interference radius of 1.8m.

Assuming the separation between pedestrians on the pavement and vehicles on the road is 4m, the hearing aid user will not experience interference from the transmitter. Even if the aid is orientated with maximum susceptibility towards the road, the car would still have to be closer than 3m to cause interference.

It is unlikely that interference will be perceived from vehicles on the road whilst walking on the pavement.

4.1.2) Trains.

If it is assumed that there is a 10dB attenuation into a carriage from a roof mounted antenna, then a GSM pay phone on the train in power class 1 (20W) will have an affected radius in the train equivalent to that from a 2W transmitter.

Assuming the transmitter is located in the centre of the train, it is found that 1.2m or 1.2% of the train will be affected from equation 1. Assuming people are evenly distributed on the train then the probability of perceiving interference is 0.012.

It should be noted that investigation has shown that personal tape players are equally as susceptible to AM transmission and there is likely to be a high density of such equipment on commuter trains.

The probability of interference from a pay phone on a train is 0.012.

4.2) Bases.

4.2.1) Low sites.

If it is assumed that the BS is power class 4 (40W), then the affected area will be 942m² from equation 1.

Assuming people are evenly distributed within the cell, then the probability of a hearing aid user experiencing interference will be

$$\frac{942}{1.26 \times 10^7} = 7.5 \times 10^{-5}$$

since the area of a 2km radius cell is 12.6km².

The probability of interference from a base site whilst walking on the pavement is negligible. This is further reduced since BS's will be sited on top of buildings and not at ground level.

4.2.2) High Sites.

Many GSM BS will be located on top of tall buildings which may be office blocks containing a high density of people.

Assuming the dimensions of a typical office block are 60 x 15 x 15 m with a BS antenna mounted 10m above the top floor then radiation at angles greater than 60 degrees from the main lobe will penetrate the building assuming the antenna has not been tilted to modify coverage.

The vertical radiation pattern from a typical sectorized BS antenna shows that radiation at 60 degrees or greater from the main lobe is suppressed by 20dB to 50dB and thus, assuming an attenuation of 10dB [Ref.6] into the building and a further 5dB from the roof (no windows) gives a minimum attenuation of 35dB.

Assuming the transmitter is in power class 1 (320W) 55dBm, then the analogous scenario is a 55-35 = 20dBm (100mW) transmission into free space. This equates to an interference radius of 0.26m at 60 degrees from the main lobe and 0.8cm (65dB attenuation) vertically downwards from equation 1.

It is therefore unlikely that hearing aid users in an office block directly underneath a GSM BS will experience any interference even if they are at the top of the building and the BS is in power class 1.

4.2.3) Building coverage.

A typical attenuation into a building is 10dB [Ref.6] and thus the interference radius from a class 4 BS (40W) into a building will be equivalent to that from a 4W transmitter into an open site. It follows that any building within a 1.7m radius from the BS will have sufficient field strength inside the building to give rise to interference to hearing aid users.

As this distance is not practically realisable, it is most unlikely that a BS will give rise to interference in adjacent buildings.

4.3) Portables and Transportables.

4.3.1) Railway Station.

Portable GSM transmitters may be in power class 4 and will hence have a

maximum power of 2W. This gives rise to an affected area of 4.4m^2 per transmitter, assuming no antenna gain at the portable, from equation 1.

Taking the area of a platform as $100\text{m} \times 10\text{m} = 1000\text{m}^2$ and the number of platforms as 10 then the total station area is $10,000\text{m}^2$. If each train has 10 carriages carrying 100 people, and a train arrives at each platform during the rush hour simultaneously then $1000 \times 10 = 10,000$ people will be in the station at any one time leading to 1 person per m^2 .

The population of greater London is roughly 7 million in an area of 1580km^2 which is assumed to rise to roughly 10 million, from traffic flow analysis, during working hours.

Assuming the station is located in a 2km radius cell of area 12.6km^2 and that the population of London is evenly distributed in the 1580km^2 within Greater London, then

$$10 \times 10^6 \times \frac{12.6}{1580} = 80,000$$

people will be in the cell.

Since there are 10,000 people in the station during rush hour (1/8th of the total), assuming the cell is 50% loaded and that 50% of calls will be from hand portables then $28 \times 1/8 = 3.5$ calls will be active in the station at any one time during rush hour with a 10MHz allocation.

Since each transmitter has an affected area of 4.4m^2 around it then a total area of $3.5 \times 4.4 = 15.4\text{m}^2$ (0.154%) of the station area will be affected. There is thus a probability of 0.00154 that a hearing aid user will be in an affected area assuming class 4 portable transceivers.

When the system finally occupies 25MHz, the number of calls originating in the station from hand portables rises to $80 \times 1/8 = 10$, the affected area to $10 \times 4.4 = 44\text{m}^2$ and thus the probability rises to 0.0044.

The probability of interference from a hand portable transceiver in a railway station is 0.00154 with a 10MHz allocation and 0.0044 with 25MHz.

4.3.2) Office.

It has been found that there are 80,000 people in a 2km radius cell thus with a 50% loaded cell and a 10MHz allocation, 28 of these (1 in 2800) will be using a GSM hand portable. A typical office has 1 person in 10m^2 and hence with a 10 storey building with 100 people per floor there will be 1000 people in $10,000\text{m}^2$.

Since 1 in 2800 people will be using a GSM transmitter, 0.36 people in the building will be radiating 2W (class 4) giving a total affected area of 1.6m^2 from equation 1. This equates to 0.016% of the office area and hence a probability of interference of 0.00016 assuming even distribution of workers.

With a 25MHz allocation, 1 in 1000 people will be using a GSM hand portable and thus the total affected area will be 4.4m^2 from equation 1 and the interference probability rises to 0.00044.

The probability of interference from hand portable transceivers in an office block is 0.00016 with 10MHz allocated and 0.00044 with 25MHz.

4.3.3) Street.

Assuming the pavements of central London are 3m in width and are located on both sides of the road then, knowing there are 17.5 km of road per km^2 , we have a pavement area of $17.5 \times 10^6 \times 2 \times 3 = 100,000\text{m}^2$ in 1km^2 . Assuming there is 1 person per 5m^2 then there will be 20,000 people on the pavements in 1km^2 .

Assuming this represents a 50% loaded cell and the allocation is 10MHz then there

will be 28 actively transmitting hand portables distributed between 20,000 people (1 in 714).

Since the pavement is 3m in width then there will be 1 person every 1.6m and hence 1 hand portable every $1.6 \times 714 = 1143\text{m}$. Assuming the transmitter is stationary and the hearing aid user is walking at 3km/h (0.83m/s), then it will take 23 minutes to walk between transmitters.

When the system occupies 25MHz, there will be 1 in 250 people with an actively transmitting hand portable and thus one transmitter every 400m. At 3km/h it will take 8 minutes to walk between transmitters.

If the transmitter is in power class 4 (2W) then the interference radius will be 1.2m from equation 1, and thus the subject will have to walk for 2.4m whilst experiencing interference. At 3km/h this will take 2.9 seconds.

Therefore, a hearing aid user walking along a London street during peak time will experience 2.9 seconds of interference from hand portable transceivers every 23 minutes with 10MHz allocated and every 8 minutes with 25MHz.

4.3.4) Train.

Since it has been shown that there are 80,000 people in a 2km radius cell and assuming 50% of the 112 channel capacity will be taken up by hand portables then 1 in 2800 people will carry portable transceivers.

Assuming the train is carrying workers to London, then roughly 0.36 people will be using a GSM hand portable. If this is a class 4 (2W) transmitter then the interfering radius will be 1.2m and hence, assuming the transmitter is not at the end of the train, a $0.36 \times 2.4 = 0.9\text{m}$ length of the train (0.9%) will be affected. Assuming an even distribution of people, the probability of interference is 0.009.

With a 25MHz allocation, the penetration rises to 1 transmitter in 1000 people and thus 2.4% of the train will be affected and the probability rises to 0.024.

Again there are likely to be a large number of personal tape players on such a train which have been found to be equally as susceptible to interference.

The probability of interference from a hand portable transceiver on a train is 0.009 with 10MHz allocated and 0.024 with 25MHz.

5) 'A Day in the life of' scenarios.

5.1) Daily commuter from outside London.

This day in the life of a hearing aid user is made up of the following scenarios

Travel from home (rural) to railway station and return	2 x 15mins = 30mins
Return train journey to London	2 x 1hr = 2hrs
Time spent leaving and waiting for train	2 x 15mins = 30mins
Tube journey	2 x 15mins = 30mins
Walking to and from office	2 x 15 mins= 30mins
Time spent in office	8hrs

The travel conducted in the rural area and on the tube may be ignored since there will be no interference.

When travelling on the train, interference may be caused by a pay phone on the train or from a hand portable. The probability of perceiving interference from either of these

sources is

$$\begin{aligned} P_{\text{total}} &= P_{\text{payphone}} + P_{\text{portable}} + P_{\text{payphone}} P_{\text{portable}} \\ &= 0.012 + 0.009 + 1.08 \times 10^{-4} \\ &= 0.021 \text{ for } 10\text{MHz} \end{aligned}$$

$$\begin{aligned} P_{\text{total}} &= 0.012 + 0.024 + 2.88 \times 10^{-4} \\ &= 0.036 \text{ for } 25 \text{ MHz} \end{aligned}$$

Assuming the average duration of a call is 2mins and since the time spent on the train is 2 hours, then

$$\text{Total interference duration} = 120 \times 0.021 = 2.5 \text{ mins}$$

$$\text{Number of calls} = \frac{2.5}{2} = 1.26 \text{ calls}$$

$$\text{Time between calls} = \frac{120}{1.26} = 95 \text{ mins}$$

Substituting $P_{\text{total}} = 0.036$ gives a corresponding time between calls for a 25MHz system of 56 minutes.

It will be noted that if the probability of interference from the pay phone and the hand portable transceiver are separated, the time between exposure to interference for the duration of a call is 167 minutes due to the pay phone, 222 minutes due to the hand portable with 10MHz allocated and 83 minutes due to the hand portable with 25MHz. *Whilst on the train interference will be experienced for 2mins every 95mins for a 10MHz system and every 56 mins for a 25MHz system.*

Whilst in the railway station, the probability of incidence of interference is 0.00154 (10MHz) or 0.0044 (25MHz). Assuming 30 minutes (1800s) are spent in the railway station and a call lasts for 2mins, then

$$\text{Total interference duration} = 1800 \times 0.00154 = 2.8\text{seconds}$$

$$\text{Number of calls} = \frac{2.8}{120} = 0.02 \text{ calls}$$

$$\text{Time between calls} = \frac{30}{0.02} = 22 \text{ hours}$$

Substituting a probability of 0.0044 gives a corresponding time between calls for a 25MHz system of 7.6 hours.

Whilst in a railway station, interference will be experienced for 2 mins every 22 hours for 10MHz and every 7.6hours for 25MHz.

It has been shown in section 4.3.3 that a 2.9 second burst of interference will be heard every 23 minutes for 10MHz and every 8 minutes for 25MHz.

During the 8 hours in the office, the probability of interference is 0.00016 with 10MHz and 0.00044 with 25MHz. Assuming 2 minute call duration then

$$\text{Total interference duration} = 8 \times 60 \times 60 \times 0.00016 = 4.6\text{seconds}$$

$$\text{Number of calls} = \frac{4.6}{2} = 0.038 \text{ calls}$$

$$\text{Time between calls} = \frac{120}{0.038} = 208 \text{ hours}$$

Substituting a probability of 0.00044 gives a corresponding time between calls for a 25MHz system of 75 hours.

Whilst in the office, interference will be heard for 2 minutes every 208 hours for a 10 MHz system and every 75 hours for a 25MHz system.

Overall conclusion of scenario 5.1.

The incidence's of interference will be as follows :

10MHz.

- 1 x 2 minutes every day on the train
- 1 x 2 minutes at the station every 1.5 months
- 1 x 3 second burst every day whilst walking on the street
- 1 x 2 minutes every month in the office

25MHz.

- 2 x 2 minutes every day on the train
- 1 x 2 minutes at the station every 2 weeks
- 4 x 3 second burst every day whilst walking on the street
- 1 x 2 minutes every 9 days in the office

5.2) Person working and dwelling in London.

This day in the life of a hearing aid user may be characterized bt the following scenarios :

Walk from home to tube station	2 x 15 mins = 30mins
Tube journey	No interference
Walk from tube station to office	2 x 15 mins = 30mins
	Total time on street = 60 mins
Time spent in office	8 hours

Overall conclusion of scenario 5.2.

Using the reasoning in 5.1, the incidence of interference will be as follows.

10MHz.

- 3 x 3 second burst every day whilst walking on the street
- 1 x 2 minutes every month in the office

25MHz.

- 7 x 3 second burst every day whilst walking on the street

1 x 2 minutes every 9 days in the office

5.3) Retired person.

Whilst the retired person is dwelling in a rural area, the incidence of interference will be negligible. However, if that person spends a day shopping in London, the day may be characterized as follows.

Travel from home (rural) to railway station and return	No interference
Return train journey to London	2 x 1hr = 2hrs
Time spent leaving and waiting for train	2 x 15mins = 30mins
Tube journey	No interference
3 hours shopping of which 1 hour is spent in the street	1 hour

Overall conclusion of scenario 5.3.

Using the reasoning in 5.1, the incidence of interference will be as follows.

10MHz.

1 x 2 minutes on the train
Unlikely incidence of interference at station
3 x 3 second burst whilst walking on the street

25MHz.

2 x 2 minutes on the train
Unlikely incidence of interference at station
7 x 3 second burst whilst walking on the street

5.4) Motorway traffic jam.

It has been shown [Ref.10] that a hearing aid user driving a vehicle on a motorway, with the aid orientated such that maximum susceptibility is towards the traffic, will experience interference if the adjacent vehicle is radiating a GSM transmit power of more than 2W.

It was found that the probability of the adjacent vehicle having a GSM transceiver was 0.05 and that if the traffic had a relative speed of 5 mph interference would be heard for 2 seconds every 4 minutes.

6) Discussion.

6.1) GSM customers with hearing aids.

6.1.1) Hand-Portables.

Equation 1 states that $A_{tot} = 2.18 P_t$ and hence $d_{max}^2 = \frac{2.18 P_t}{\pi}$

The distance between the ears is less than 0.25m and hence

$$P_t = \frac{0.25^2}{0.7} = 90\text{mW}$$

or, the maximum transmit power from a hand-portable transmitter held to the unaided ear is less than 90mW to prevent interference to the hearing aid on the other ear.

If it is assumed that minimum susceptibility is in the direction of the transmitter (i.e through the head) than this power may rise to 210mW. Since GSM hand portable's in power class 5 will be radiating 800mW, a hearing aid user will be unable to use such a transceiver when not under power control.

6.1.2) Transportables.

Transportable transceivers will be in power class 2 and will hence radiate a maximum power of 8W with an interference radius of 2.4m from equation 1. The operator of such a transceiver will obviously be within this radius and hence interference will be perceived by a hearing aid user whilst a call is being made. It is possible that the subject could orientate himself with respect to the antenna to eliminate the interference and make a call possible.

6.1.3) Mobiles.

An investigation [Ref.9] has shown that a hearing aided driver of a vehicle is likely to be able to use a GSM mobile transmitter provided the antenna is mounted in the centre of a continuous metallic roof. Other antenna positions or a non-metallic sun-roof may lead to unacceptably high field strength inside the vehicle.

6.2) Solutions.

It was noted during interference testing, that the 100% AM introduced by the TDMA structure of GSM was the cause of the interference and that continuous GMSK had no effect. The interference from the base site could therefore be eliminated by full loading at all times i.e all time slots active all the time and constant amplitude transmission. However this dramatically increases C/I for the following reasons :

- i) Continuous transmission requires unused time slots to be active
- ii) Discontinuous transmission (DTX) at the BS would be impossible leading to a two fold degradation in spectral efficiency since one way speech is interspersed with roughly 50% of silence.
- iii) Adaptive power control at the BS would be impossible since this would be required on individual time slots leading to amplitude modulation of the carrier.

It should be noted that anything less than 100% loading will result in a similar audio spectrum perceived by the subject as having only one time slot active. This is to say that the audio spectrum demodulated from a one time slot active BS will be the same as that from one with one time slot inactive.

The base site scenarios presented in this document are based on the results of the interference studies at BTRL i.e one carrier active. However, a GSM base site will have 8 carriers per cell when occupying 5MHz per operator and utilizing a three cell repeat pattern. Since TDMA frames on separate carriers will be synchronised at the BS, the broadband AM demodulation process may give rise to 8 times (9dB) increase in

interference level when corresponding time slots are active.

6.3) Other interferences.

The two hearing aid users who took part in the original susceptibility testing were given a questionnaire concerning current levels of interference.

It was determined that one subject used his hearing aid only once or twice a month where the other used his for the majority of the working day. The times when the aids would definitely be used were in the office, at meetings and during lectures.

Both subjects very rarely perceived any interference to their aids with one recalling only ever hearing a single burst lasting for several minutes. The second subject recalled hearing bursts lasting a second or so very infrequently and identified the source as fluorescent lights.

6.4) Possible variables.

The scope of this model is seen to be small and dominated by assumptions. There follows a list of variables that may significantly affect the conclusions drawn from the model.

- i) The hearing aid user may switch the aid off for periods of the day when verbal communication is not essential.
- ii) Hearing aid users may identify the source of the interference and learn to position themselves away from this source.
- iii) The scenarios only apply to Greater London.
- iv) There tends to be a natural exclusion zone around a person using a hand portable transceiver which will reduce the area in which a hearing aided pedestrian may be and hence reduce the probability of interference.
- v) Discontinuous transmission at the MS will produce breaks in transmission will change the way in which interference is perceived.
- vi) Not all trains will have a public pay phone and those that do will have the phone located between carriages i.e where there are no passengers.
- vii) The hearing aided population will be biased towards retired people who do not commute into the city.
- viii) Due to the nature of the calculation, the number of exposures to interference are average figures. The standard deviation away from this mean is likely to be large.
- ix) The 'hand portable on a train' figures may be significantly reduced if the hearing aid is not located in the centre of the train and if a significant attenuation of the transmitted signal is created by the crowded environment.

7) Conclusions.

- i) The scenarios presented in this document suggest that the maximum incidence of GSM interference will be from hand portable and transportable transceivers since this apparatus is carried by the public into areas of high population concentration.**
- ii) There is also a significant probability of interference from a public pay phone on a commuter train.**
- iii) It appears that a hearing aid user will be unable to use a GSM portable or transportable transceiver in any power class.**
- iv) It is likely that a hearing aid user will be able to use a vehicle mounted transceiver provided the antenna is mounted in the centre of the roof.**
- v) Since it has been found that interference may be perceived infrequently from other sources, then it is GSM interference perceived daily that gives rise to the most concern.**
- vi) Of the four 'day in the life of' scenarios chosen the daily commuter to London from a rural area is most likely to experience regular interference with a daily exposure for the duration of a call (2mins) whilst on the train and a 3 second daily burst whilst walking on the street even with the initial 10MHz allocation. This rises to two daily exposures for a call duration and four 3 second daily bursts when the allocation reaches 25MHz.**
- vii) The scenario of the London worker dwelling in the city highlights a smaller exposure to interference. Whilst operating with a 10MHz allocation, three 3 second bursts will be experienced on the street every day rising to seven daily bursts with system maturity.**
- viii) The retired person is far more likely to be wearing a hearing aid but less likely to be in the city. If spending a day shopping in the city, the exposure to interference will be high during that day with a burst for a call duration during the train journey and three 3 second bursts whilst walking between shops. This rises to two exposures for a call duration and seven 3 second bursts with system maturity.**
- ix) Whilst in a vehicle in a motorway traffic jam moving at 5mph, a hearing aid user will experience bursts of interference lasting 2 seconds every 4 minutes.**
- x) It can be seen that given the current immunity of NHS hearing aids to 900MHz GSM EMI, a person wearing such an aid and requiring to use it during the working / travelling day will experience regular daily interference as the GSM system matures.**
- xi) If the incidence of interference is deemed unacceptable, a greater hearing aid immunity at 900MHz will be required to reduce the incidence of GSM interference, since there appears to be no practical modification to the GSM structure that will achieve this.**

8) References.

- 1) Central Statistical Office - 'Annual abstract of statistics 1987'
HMSO No. 123
- 2) Central Statistical Office - 'Regional trends 1985'
HMSO
- 3) CCIR - 'VHF and UHF propagation curves for land mobile services'
CCIR Rec.529 Rep.567-3
- 4) GSM recommendations 03.30 and 05.05
- 5) Short J M - 'An investigation into the effects of RF interference on
hearing aid users' 23/8/89
- 6) IEE Group E11 - 'Propagation factors and interference modelling for mobile radio
systems' IEE Colloquium, Digest No. 1988/123
- 7) Holbeche R J - 'Land mobile radio systems' IEE Telecomms series 14
Peter Peregrinus 1985
- 8) Tattersall P R - 'Domestic equipment susceptibility to GSM mobile radio
transmission' 13/6/89
- 9) Short J M - 'An investigation to determine the penetration of 900MHz RF into
vehicles' 23/10/89
- 10) Munday P J - 'GSM EMC scenario model - Motorway traffic jam' 9/1/90
- 11) Short J M - 'GSM Interference Scenarios' 30/11/89
- 12) Short J M - 'A day in the life of a hearing aid user' 9/1/90
- 13) Munday P J - Correspondence of 31/1/90 and 12/12/89

Annex B: GSM - Hearing aid interference modelling parameters

GSM - HEARING AID INTERFERENCE

MODELLING PARAMETERS

Interference levels causing "audible slightly annoying" interference. } 4V/m in model
(5 to 8.5 V/m measured)

Attenuation produced by wearer's head: Up to 8 dB

GSM Power Level	Distance from GSM Transmitter	
2W	0.8m to 1.9m	
5W	1.3m to 3.0m	
8W	1.6m to 3.8m	
20W	2.4m to 6.0m	
	↑	↑
	Best side of head	Worst side of head

Note - Metallising hearing aid case gave about 10dB reduction in susceptibility

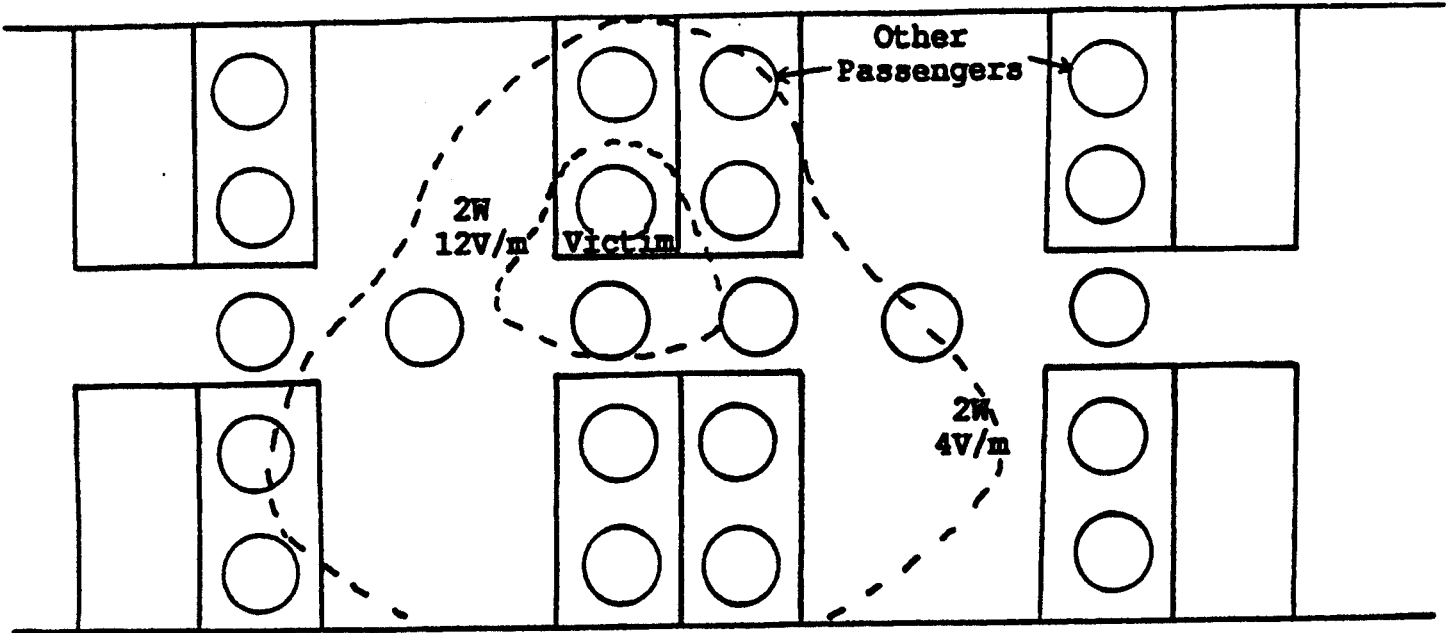

1 other passenger in 2W, 12V/m area
 10 other passengers in 2W, 4V/m area

Crowded Train Scenario

Crowded Train Scenario

Assume: Half GSM HPU's used on a given journey
 Average call lasts 2 min

Passengers with 2W GSM HPU	Probability of 2 min interference on a given journey	
	4V/m	12V/m
1%	5%	0.5%
3%	14%	1.5%
10%	40%	5%

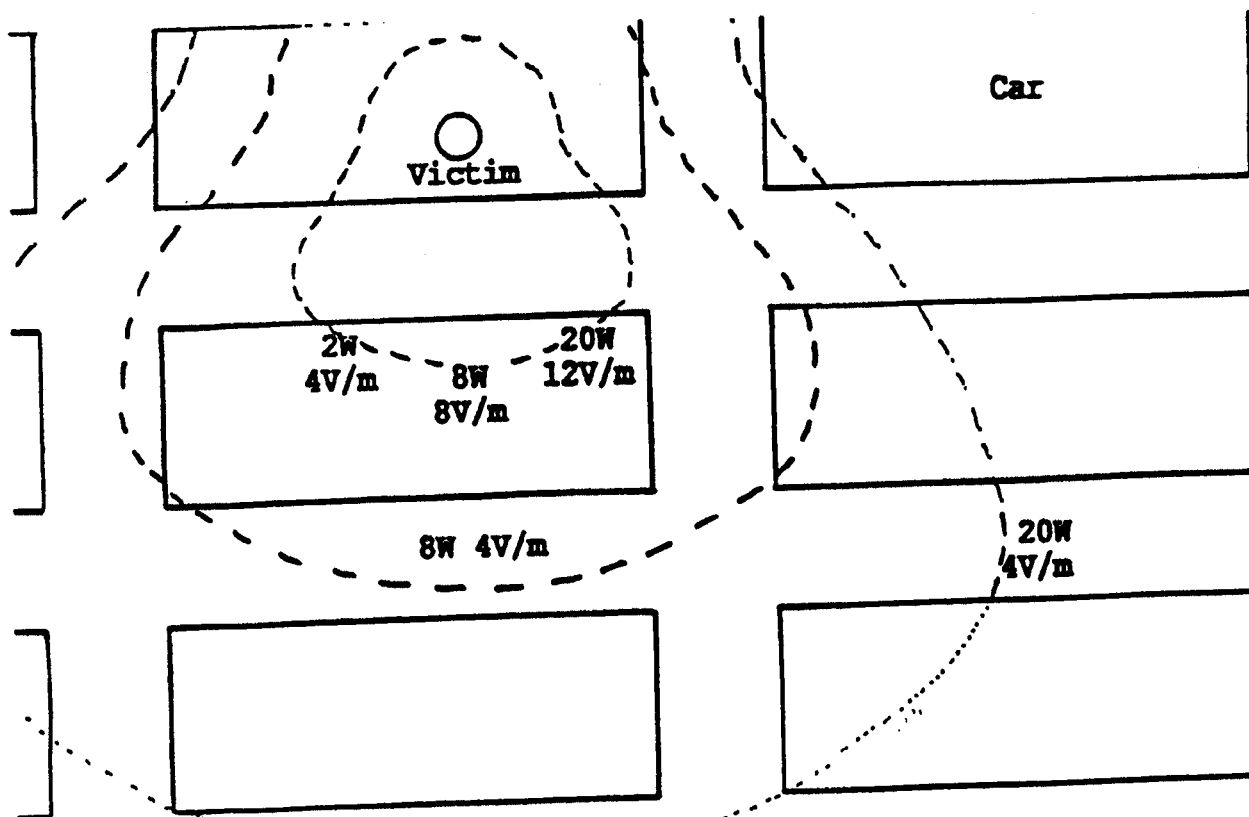

Motorway Traffic Jam Scenario

Motorway Traffic Jam Scenario

Assume: 5% of vehicles have GSM phone
 20% of GSM phones active at a time
 Average calls last 2 minutes

Traffic	Interference	2W	8W	20W	8W	20W
		4V/m	8V/m	12V/m	4V/m	4V/m
Stationary	2 min interference bursts with Prob →		2%		5%	10%
Lanes passing at 10km/hr	Interference bursts → (on average)		0.7s every 3 min		2s every 3 min	3s every 2.5 min

Annex C: New digital transmission technologies - the EMC conundrum

NEW DIGITAL TRANSMISSION TECHNOLOGIES - THE EMC CONUNDRUM

1 INTRODUCTION

The growth of our 'cordless' society has placed a premium on personal mobility. In the telecommunications sector the growth in the use of cordless telephones and cellular radios has been spectacular. To provide for this growth, in an age where frequency spectrum is similarly in demand, has required the development of new technologies.

2 RADIO TECHNOLOGIES

Recent developments in radio in Europe and worldwide have selected 'time division multiple access' (TDMA) technologies for assigning channels to individual radio users. The traditional frequency division multiple access (FDMA), mainly analogue, techniques are still used extensively but are slowly being replaced by digital TDMA systems, which offer both improved performance and spectral efficiency, particularly in large 'public systems'.

3 WANTED RF EMISSION

In a TDMA system the 'channel' used by an individual represents one time slot from say 10, allocated to that user normally at a sub-audio rate, for example, 200Hz.

The resultant effect is that a burst of RF is transmitted at that sub-audio rate, in the example above the RF burst would last for 5 msec and be repeated every 50 msec. The 5msec RF burst would contain the transmitted information at a rate 10 times faster than the basic rate to provide a continuous transmission for the user.

The RF signal described above is amplitude modulated (AM), in this case at 200Hz, this AM is in addition to the modulation contained within the RF burst itself. Tests to date have shown that many radio and non-radio (particularly audio products) are susceptible to an RF signal with these characteristics.

The growth of cordless telephones and personal communications equipment also means that the transmitter will be physically much closer to potentially susceptible equipment.

4 EMC DIRECTIVE AND LEGISLATIVE PROVISION

The Community's EMC Directive requires that all electrical/electronic equipment neither emit nor radiate unwanted RF signals, and not be susceptible to other (wanted) RF signals, ie legitimate radio transmissions.

Legitimate radio transmissions are licensed in the UK by the Radiocommunications Agency of DTI, under the 'Wireless Telegraphy' Acts. The licence provision includes the frequency, form of modulation, permitted power level and

controls spurious and other parameters by only licensing equipment approved to definitive standards of performance.

The EMC Directive will come into force on 1 January 1992; it offers the power to control, from that date, equipment 'placed on the market' and will require compliance with essential immunity' standards.

The pan-European digital cellular radio system - GSM - which is also supported by a Community Directive, should become operational at a similar date. The WT Act licence offers the potential to control the power levels of GSM equipment.

5 THE CONUNDRUM

The 'generic' immunity standard being set by CENELEC has been currently agreed to be set at '3 volts per metre'

The immunity standard necessary to avoid interference from a GSM equipment will need to be in the range '10 volts per metre' to '20 volts per metre' if the current power levels of GSM equipments are to be maintained. It is, of course, subject to the distance between the GSM transmitter and the target device being defined.

The obvious incompatibility and potential hazard to 'safety related' or 'pseudo-medical' applications eg hearing aids, provides the conundrum.

6 DISCUSSION

Scant regard, has in the past been paid to the design of equipment with realistic immunity standards - particularly in the domestic market. The EMC Directive provides the legislative framework to correct this deficiency. The 'generic' immunity standard of '3 volts per metre' has been pitched at a level that most equipment designs already meet and thus provides little or no real improvement. A more realistic figure would be '10 volts per metre'.

The adoption of TDMA technology, with its inherent advantages is more intrusive, in EMC terms, than previous FDMA technologies. This is particularly true of 'audio' equipments such as personal stereos, which have a high probability of being in close proximity to the new digital radio telephones.

It could be argued that the AM component of the TDMA transmission is also 'unwanted' and hence covered by the EMC Directive; this view is not shared by the spectrum managers, where it seen as a legitimate and efficient transmission.

The spectrum manager has the option of defining the maximum radiated power, to a level compatible with realistic immunity standards.

7 CONCLUSION

A compromise between 'immunity' standards for all radio and non-radio equipments, coupled with a limitation of radiated power from, particularly hand held TDMA transmitters, will be essential to avoid unwanted EMC problems. The attached Annex proposes a scenario for discussion purposes.

O J WHEATON 4.5.90

EMCCONUN

ANNEX

EMC CONSIDERATIONS

1 Assumptions:

- the minimal distance between a radio transmitter and a target radio or non-radio equipment shall be 1 metre;
- safety conscious and pseudo medical systems shall have higher immunity standards than the 'generic' standard level.

2 Proposes that:

- generic immunity standards for all equipment be set at 10 volts per metre minimum;
- sectorial immunity standards for body worn audio equipments be set at 15 volts per metre minimum;
- sectorial immunity standards for any 'safety conscious' system be set at 25 volts per metre minimum.

3 Transmitters using AM or TDMA technologies be limited in radiated power to:

- hand held devices - 1 watt peak power;
- vehicle mounted equipment, where the antenna is at a minimum height of 1.5m, located at least 0.75m from the vehicle's outline - 5 watt peak power.

Annex D: Potential GSM hazards on cardiac pacemakers

Source: CSELT (Italy)

Potential GSM Hazards on Cardiac Pacemakers

1 - Pacemaker Operation

Cardiac pacemakers are pulse generators implanted in subjects suffering from heart disease in order to stimulate artificially the beat of the heart.

Demand types sense when the heart beat is abnormal and make necessary corrections. Most pacemakers in use are of the demand type.

A simplified block diagram of a demand type pacemaker is shown in fig.1. The circuit and the power supply (a solid state battery) are sealed in a titanium package to reduce the rejection phenomena as well as to improve the electromagnetic shielding.

The circuit is implanted in the abdomen of the patient while the pacing lead carries the pulses directly to the heart.

The pacing lead is a catheter introduced through veins and has the double function of exciting the cardiac activity and detecting the spontaneous signals. In fact when the detector reveals the natural heart beat (which is an electric pulse with a peak to peak amplitude near to 5 mV) turns off the pulse generator (which give out a peak to peak pulse of approximately 5 V). So acting the pacemaker reduces the power consumptions and avoids unnecessary stimulations. There are two different kinds of pacing leads: unipolar and bipolar. bipolar leads are less sensitive to the external interferences but they are less sensitive to the cardiac signal too.

Single channel and multichannel devices (i.e. with a stimulation and detection in more than a single heart point) are available according to the patient needs. In a large part of the pacemakers the physician can program the parameters of the implanted generator (e.g. amplitude, frequency, sensitivity) using a radio interface controlled by a computer. Moreover the radio interface allows the physician to get the operating parameters of the stimulator using some telemetry measurement functions built in into the device.

2 - GSM Interference to Pacemakers

Since the pacing lead acts as an antenna, exposure to an electromagnetic field may:

- a) Introduce currents from the leads into the heart causing fibrillation or local heating;

- b) Induce voltages in the lead that damage the pulse generator;
- c) Induce voltages in the lead that the pacemaker confuses with the intrinsic heart signal and turn off the pulse generator.

Additionally implantable pulse generators incorporate reed switches which are used for controlling the battery charge and may be activated by strong magnetic fields.

The safety of implantable pacemakers and their protection against EMI (Electro Magnetic Interference) is the subject of the CENELEC European Standard 56001.

A draft amendment prepared by the Technical Committee 62 [1] suggests both the maximum ratings of interference and the measurement methods to which pacemakers should comply.

Surely clauses a) and b) do not concern the GSM system because the power of a direct radiation excited in the lead which can damage the heart or the pulse generator is very much higher than the power of the GSM fixed or mobile equipments. Moreover the transmission frequencies of the GSM system are so high that the by-pass capacitor which protects the pacemaker input filtrates enough the residual components. For instance it has been verified that AM radio broadcast transmissions using very high power (kilowatts or megawatts) can introduce a strong hazard.

Instead, clause c) has needed some investigations because an interfering signal with low frequency components approximating the heart beat could cause potential hazards even if their power is relatively low.

In case of GSM signals, while the normal burst transmission has a repetition rate of 216 Hz and risks cannot arise (consider that a 50 Hz component is already strongly filtered by the post-detector filter of the pacemaker detector input), the particular case of DTX (Discontinuous Transmission) mode had to be carefully investigated.

In fact DTX mode has signal components at frequencies much lower than in the case of normal GSM transmissions (see fig. 2): there is a sub-component with a repetition rate of 2.08 Hz, which corresponds to the transmission of the 8 timeslots of the SID (Silence Descriptor) message block frame and another low frequency component represented by the SACCH repetition rate (8.33 Hz). The amplitude and duty cycle (one timeslot out of 26) of this component are much lower than those of the previous one. Since electrical signals with a periodicity below 6-8 Hz inhibit the pulse generator while interfering signals with a periodicity above 6-8 Hz will revert the pacemaker operation into the so called asynchronous mode at the basic programmed rate, it was fundamental importance to identify possible danger thresholds.

In fact, if the power excited by these signals in an active pacemaker were high enough, the pulse generator could be turned off and the person could have a heart failure.

3 - Experimental Tests

Compatibility tests have been conducted both with unipolar and bipolar pacemakers manufactured by SORIN using the test set-up shown in fig. 3.

An arbitrary waveform generator jointly with an RF generator simulated the 900 MHz DTX transmission. The signal was amplified by a power amplifier.

Pacemakers were placed in a phantom, an imitation of the human body filled with a physiological solution (water and NaCl whose concentration corresponded to a specific conductivity of 0.5 S/m at 20°C room temperature) according to the standard values.

The phantom was a Plexiglas cylinder 1.7 m tall, with a diameter of 0.3 m. The pacing lead was placed in a loop similar to the one really done in the human chest and his distance from the plexiglas wall was not larger than 1 cm. An oscilloscope connected to two steel plates plunged into the solution was used to detect the regular operation of the generators.

Experiments were conducted in a controlled (anechoic) environment with the aim of measuring the field strength next to the phantom chest by an isotropic detector avoiding any unwanted component.

The measurement results show that no risk of hazards exists against pacemakers from GSM equipment.

In fact it has been verified that it is necessary an electric field of at least 40 V/m (corresponding to 8 W transmit peak power of a GSM equipment at 0.5 m distance) for inhibiting an unipolar pacemaker when the device is leaved in the air with the pacing lead loaded with a 500 ohm resistor simulating the tissue interface.

On the other hand, when the device was put into the physiological solution, it was not possible to inhibit his regular operation even with electric fields of 200 V/m (corresponding to 208 W transmit peak power at 0.5 m distance).

For bipolar pacemakers the results are even more reassuring: with the device in the open air the electrical field could inhibit the pulse generator only if it was above 75 V/m (corresponding to a transmit peak power of 28 W at 0.5 m distance). Obviously no inhibitions have been detected with the pacemaker plunged into the solution.

4 - Conclusions

DTX transmissions of a GSM equipment produce waveforms which could inhibit cardiac stimulators but formal experiments carried out with modern unipolar and bipolar pacemakers manufactured by SORIN have demonstrated that no real hazard exists.

References

- [1] "Safety of implantable cardiac pacemakers". Draft CENELEC pr EN 50 061 (1989)
- [2] "Immunity to disturbance of cardiac pacemakers in RF fields of powerful radio transmitters". Institut fur Runfunkttechnik GMBH, Munchen, 1987.

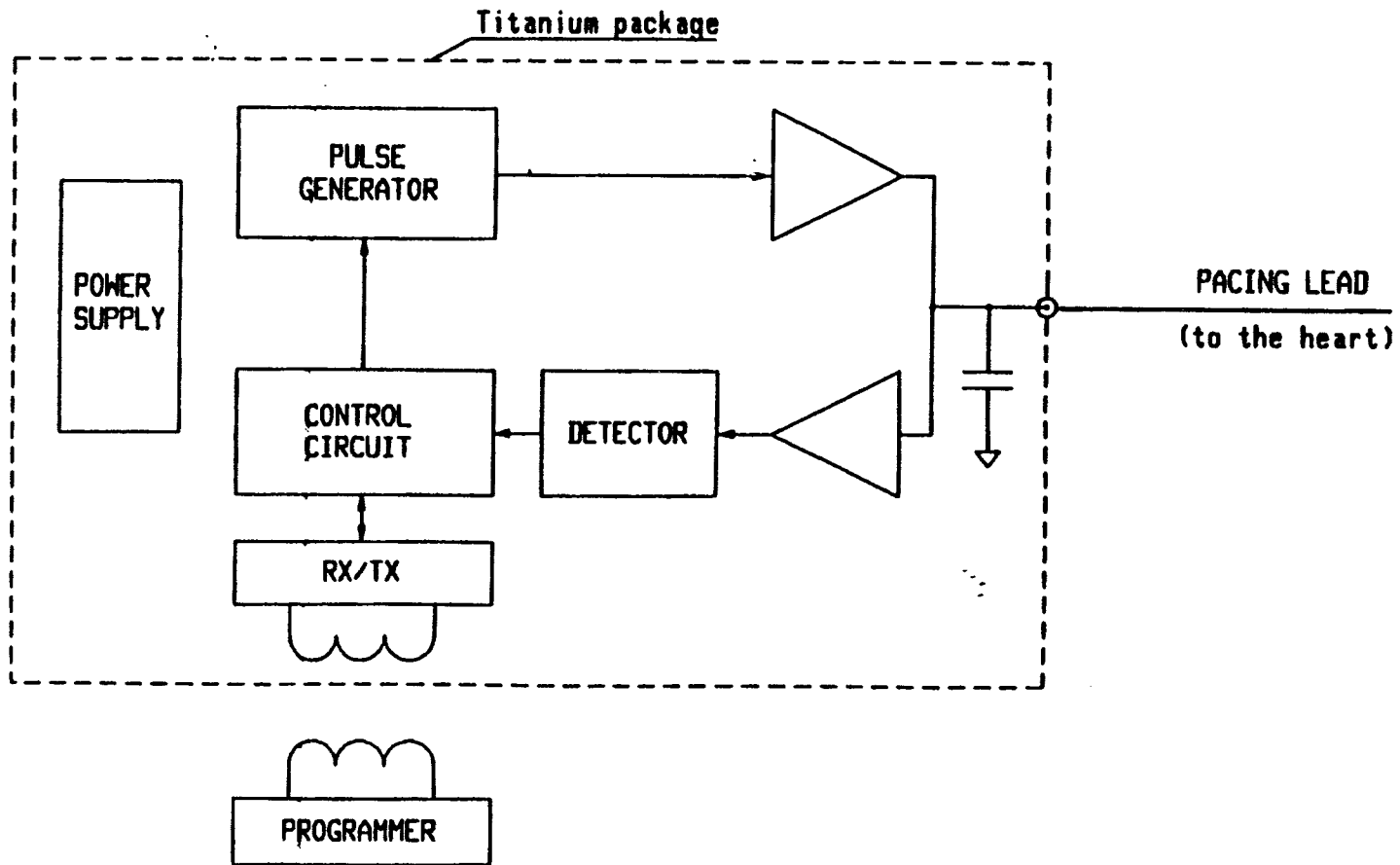

Fig. 1 Schematic diagram of a cardiac pacemaker

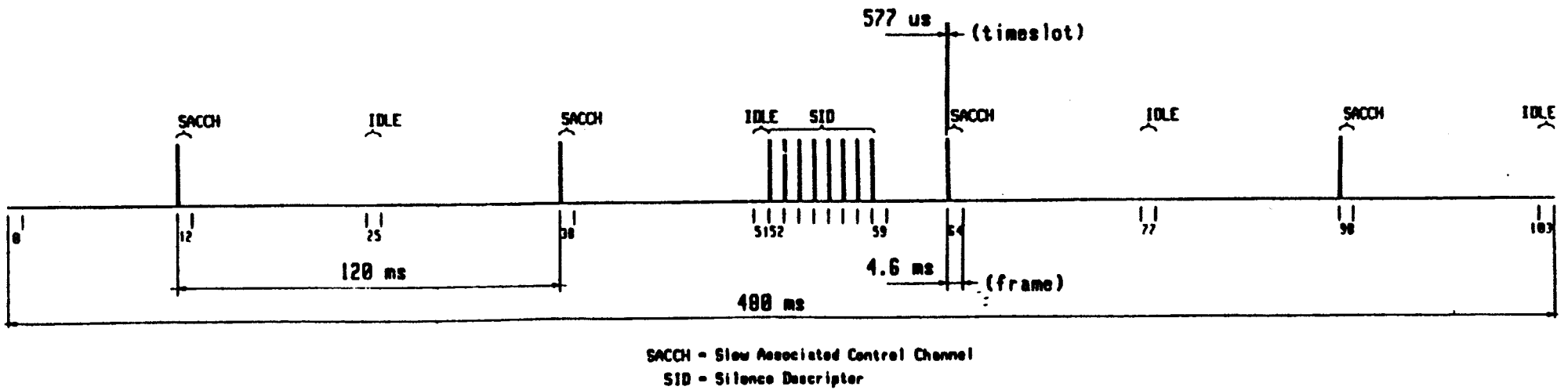

Fig. 2 GSM System Discontinuous Transmission (DTX)

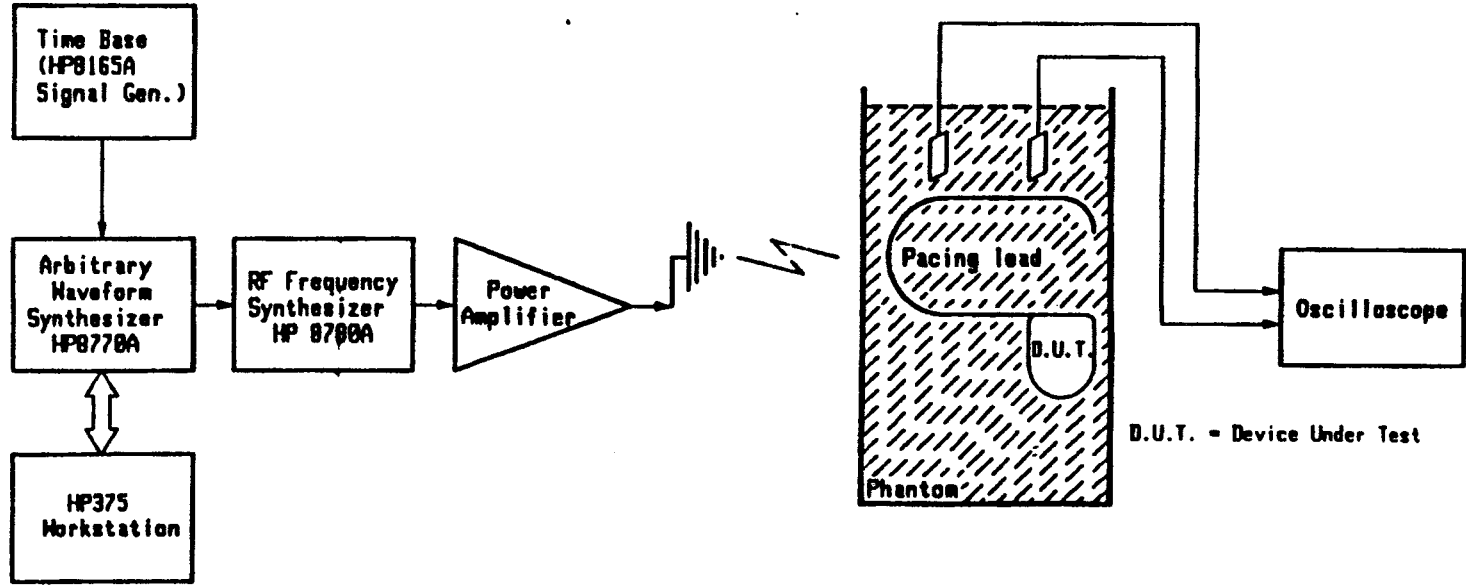

Fig. 3 Block Diagram of the experimental setup

Annex E: Summary document on GSM-TDMA interference

**Summary Document
On
GSM-TDMA INTERFERENCE**

**PROJECT: 60
Support to R2/MTS2**

July 1991

RTL File KJ201

Project Manager F Mellish, I.Eng. MIEIE

Project Technicians

Approved by

**L Williams, I.Eng. FIEIE
Head of Research and Development**

CONTENTS.

1. Summary of Requirement.
2. Summary of Findings.
3. Immunity Data.
 - 3.1 Sources of Data
 - 3.2 Normalisation of Data.
 - 3.3 Analysis of Data.
4. Observations.
5. Conclusions.

1. Summary of Requirement.

In the course of a meeting to discuss the potential interference [1] problems associated with the introduction of GSM and other transmission systems employing TDMA techniques, Mr Williams of the Radio Technology Laboratory was tasked with producing a summary document covering all of the work carried out to date.

The minutes of that meeting are reproduced in annex 5, it should be noted that the chairman stated that the summary report should aim to concern itself with the direct breakthrough problem only, and not the TV image problem which may affect the UK only.

[1] Interference to TV, radio, audio and information technology equipment, including personal stereo equipment and hearing aids.

2. Summary of Findings.

2.1 Domestic Equipments.

Television receivers and portable radios/cassette players etc. proved to be the most susceptible domestic equipments with mean immunities of 4.0 and 5.6 V/m respectively. Ignoring all receiver spurious responses, these equipments would only suffer interference from a 20 W GSM mobile at distances of less than about 8 metres (worse case assuming 100% efficiency and free space path loss).

This means that in practice, due to building attenuation etc., interference will not occur unless the transmitter and victim equipment are very close, and within the same room.

It can therefore be concluded that GSM interference is unlikely to cause any serious problems to domestic equipment being used in a domestic environment.

2.2 Hearing Aids.

Hearing aids also proved fairly susceptible, having a mean immunity of 4.1 V/m. Interference to hearing aids (and portable cassette players etc.) outside the domestic environment is likely to prove more problematic since the interfering GSM transmission is unlikely to be under the control of the user of the victim equipment.

Work conducted by the RTL and Racal Research Ltd. suggests that the immunity of small behind the ear hearing aids can be improved at reasonable cost (by about 10 dB) by applying conductive paint to the inside of the hearing aids plastic case. This would reduce the interfering range of a 5 W portable GSM transceiver to about 0.5 metres which is considered acceptable.

It can therefore be concluded that users of current hearing aid equipment are likely to experience some interference from GSM mobiles in close proximity. It is difficult to predict whether this will be a serious problem, but since the immunity of hearing aids can be improved at reasonable cost, and bearing in mind that the use of personal communications equipment will increase, it would be seem prudent for hearing aid manufacturers to investigate this course of action.

It is unlikely that the users of hearing aid equipment will be able to use any TDMA communications systems themselves (even if the low cost improvements described have been incorporated).

2.3 Higher Frequency Systems, DECT, DCS1800 etc.

The hearing aids tested proved more susceptible to 1900 MHz than 900 MHz (mean immunity 7 dB worse). This has obvious implications regarding the introduction of DECT etc.

3. Immunity Data.

3.1 Sources of Data.

Reports from the following laboratories were analysed to produce this summary document;

Radio Technology Laboratory Reports KJ109, KJ132, KJ132a, KJ181 Part1, KJ181 Part2.

British Telecom Research Laboratories Report RT4123

Netherlands PTT (hoofddirectie telecommunicatie en post) Report

Radio Frequency Investigations Report RFI\TR2\2294

3.2 Normalisation of Data.

The above laboratories presented their findings in a variety of forms. In producing this summary report it was necessary to unify the various abstract results and findings, by calculation and extrapolation, to a common form - the field intensity at which the impairment was on the limit of acceptability.

CCIR grade 3.5 impairment was considered an appropriate limit of acceptability for GSM interference since it falls halfway between the impairment that is considered acceptable, by the CCIR, for continuous interference (CCIR grade 4), and that which is only considered acceptable for a very small percentage of the time (CCIR grade 3).

The approximate field intensities that would result in CCIR grade 3 or 4 impairments can be obtained by adding or subtracting 5 dB audio impairment respectively (since a 1 dB change in the field intensity results in approximately a 2 dB change in the audio impairment (square law), multiplying or dividing the grade 3.5 field intensity by 1.33 will produce the approximate grade 3 and 4 field intensities respectively).

A description of the impairment associated with each of the standard CCIR impairment grades is given in Annex 1.

3.3 Analysis of the Data.

The original laboratories data and its conversion to field intensity for grade 3.5 impairment is given in Annex 2.

The Mean and Standard Deviation of the extrapolated data is given in Annex 3, and Summarised in Annex 4.

4. Observations.

4.1 Earlier work at the RTL has shown that the magnitude of AM or pulse[2] interference is related to the peak envelope power of the transmission. i.e. A victim equipment demonstrating immunity to 3 V/m (carrier) with 1kHz, 80% amplitude modulation, is also demonstrating immunity to 5.4 V/m peak i.e. a TDMA immunity of 5.4 V/m. This is supported by the recent tests conducted on hearing aids by RFI.

[2] 1:24< duty cycle <24:1

4.2 The recent tests conducted by RFI shows that the majority of the hearing aids tested (the smaller ones) were more susceptible at 1900 MHz than at 900 MHz (the mean immunity was 7 dB worse). This finding has obvious implications regarding the introduction of DECT etc., and is supported by some (limited) earlier work conducted by the RTL (KJ132a).

4.3 Intentionally blank for reports disseminated outside the Agency.

5. Conclusions.

5.1 The extrapolated mean/median peak TDMA field intensities at which various equipments would suffer visible/audible, but not annoying interference (approximately CCIR grade 3.5) are listed below.

Type of Equipment	Field Intensity (V/m)
Hearing Aids	4.1
Television Receivers	4.0
Video Cassette Recorders	>13.9
Satellite Television Receivers	9.5
Tuners/amplifiers	>8.3
Cassette Decks	>2.9
CD Players	>13.9
Portable Radios & Cassette Players etc.	5.6
Telephones	>7.6
Computers	>8.5
Computers (Home/Games)	>13.5
General Electrical/Electronic Equipment.	>7.8

From the above generalisation it can be seen that the most susceptible equipments are hearing aids, television receivers, cassette decks and portable radios/cassette players etc. Ignoring all receiver spurious responses [4], these would only suffer interference from a 20 W mobile at distances of less than about 8 metres (worse case assuming 100% efficiency and free space path loss). This means that in practice, due to building attenuation etc., interference will not occur unless the transmitter and victim equipment are very close, and within the same room.

It can therefore be concluded that GSM interference is unlikely to cause any serious problems to domestic equipment, being used in a domestic environment. Interference to hearing aids and portable cassette players etc. being used outside the domestic environment is more likely. Earlier work conducted by the RTL and Racal Research Ltd. suggests that the immunity of small behind the ear hearing aids can be improved at reasonable cost (by about 10 dB) by applying conductive paint to the inside of the hearing aids plastic case. This would reduce the interfering range of a 5 W portable GSM to about 0.5 metres which is considered acceptable.

[4] Although it was requested that this summary report should aim to concern itself with the direct breakthrough problem only, and not the TV image problem which may affect the UK only, the following background information is included for completeness.

The image (spurious) response of television receivers is potentially quite problematic because, for some of the higher Band V channels, this response falls within the bands allocated to TACS and GSM. However, interference via this mechanism is no worse for GSM (or other TDMA systems) than it is for analogue systems e.g. TACS. As no cases of TV image interference from TACS have been recorded during several years of operation, major image interference problems from GSM are not anticipated.

5.2 The following pertinent information has been extracted from RFI's test report RFI\TR2\2494;

5.2.1 Generic Immunity Standards.

The draft generic immunity standard (prEN 50082-1) requires the EUT to be tested at 3 V/m from 27 MHz to 500 MHz, but since there is no requirement to modulate the field it is unlikely that any hearing aid equipment would fail this test.

The final version will almost certainly require that two further tests listed in the informative annex to be carried out:

1. Electromagnetic field at a severity level of 3 V/m 80% amplitude modulated with 1 kHz tone swept from 80 MHz to 1 GHz.
2. electromagnetic field at a severity level of 3 V/m pulse modulated with a 100 Hz square wave at a frequency of 1.89 GHz.

5.2.2 Field Strength Produced by Portable Transceivers.

Based on compliance with the generic standard RFI have calculated how closely the user of a piece of hearing aid equipment may approach a portable transceiver before the level of unwanted interference becomes unacceptable, and produced the following table;

System	Power (W)	Minimum Distance (m)
CT2	0.01	0.1
GSM	2.00	1.4
	5.00	2.2
	8.00	2.8
	20.00	4.5
DECT	0.25	0.5

RFI state that;

These figures only provide a rough guide as they make no allowance for the type of modulation employed or for the disturbance of the electromagnetic field caused by the person using the hearing aid.

and that;

The values calculated above would suggest that users of hearing aid equipment are likely to experience some interference from GSM mobiles in close proximity and that they will not be able to use any of the above systems themselves.

Annex F: Interference to hearing aids by the new digital mobile telephone system, Global System for Mobile (GSM) communications standard

**Interference to Hearing Aids
by the new Digital Mobile Telephone System,
Global System for Mobile (GSM)
Communications Standard**

**Ken H. Joyner
Mike Wood**

**ELECTROMAGNETIC COMPATIBILITY SECTION
TELECOM RESEARCH LABORATORIES**

and

**Eric Burwood
Derek Allison
Ross Le Strange**

**ENGINEERING SECTION
NATIONAL ACOUSTIC LABORATORIES**

**NATIONAL ACOUSTIC LABORATORIES
a Division of AUSTRALIAN HEARING SERVICES
SYDNEY, 30 March, 1993.**



ABSTRACT

This report gives the details of some measurements on the interference caused to hearing aids by mobile telephones using the new "Global System for Mobile" (GSM) Communications Standard. The widespread use of this system may cause considerable interference to users of hearing aids. It is not known at present if hearing aids can be designed to be completely immune from this interference. This report has been written to alert all hearing aid users and those concerned with the use of hearing aids to the possible disruption to the use of hearing aids that may be caused by the new GSM system.

Table of Contents

1	Introduction	1
2	Acknowledgments	1
3	Nature of Transmission from GSM Mobile Telephones	1
4	Interference to Hearing Aids	2
5	Description of Measurements	2
6	Interpretation of the Results	3
7	Interfering Mechanism	4
8	Remedies	4
9	Conclusion	5
10	Recommendation	5
11	References	5

List of Tables

1	Field Strength for Noticeable Interference to Hearing Aids	6
2	Threshold Distances for Noticeable Interference to Hearing Aids	7
3	Measured Field Strengths Near GSM 8 Watt Transportable Mobile Telephone	8
4	Measured Field Strengths Near GSM 2 Watt Hand-Held Mobile Telephone	9

List of Figures

1	Sample Frequency Spectrum of a Hearing Aid Output with Interference	10
2	GSM Transmitter - Test Set-Up for Simulating Transmission	11
3	Hearing Aid Output with an Interfering Signal - Test Set-Up	12
4	Sample Acoustic Frequency Response of Hearing Aid	13

1 Introduction

The new mobile telephone system, using the "Global System for Mobile" (GSM) communications standard, is due for introduction in April this year. It uses digital technology and operates at radio frequencies (RF) in the 900 MHz region. The portable hand held and transportable telephones are capable of interfering with commonly used electronic equipment and can degrade the performance or even prevent the operation of hearing aids.

NAL was approached by Telecom Research Laboratories Electromagnetic Compatibility Section about the possibility of checking if the system interferes with hearing aids. Telecom was undertaking an investigation into interference caused by the digital telephones. As a result NAL and Telecom staff undertook a series of measurements designed to establish the nature and extent of interference to hearing aids.

The following is a report of these measurements, together with some recommendations.

2 Acknowledgments

Dr. Ken Joyner, Head of the Electromagnetic Compatibility Section, Telecom Research Laboratories, first approached NAL through Mr. Eric Burwood and visited NAL on 18th and 19th February, 1993 when it was established that interference may be a problem. Subsequently, measurements were carried out on 4th and 5th March 1993 to quantify the extent of the interference likely to be experienced by hearing aid users. Dr. Joyner and Mike Wood of Telecom Research Laboratories Electromagnetic Compatibility Section set up the equipment to generate the radio frequency field to simulate the telephone emissions and also provided Tables 3 and 4 of field strengths emitted by the GSM mobile telephones. Messrs. Eric Burwood, Derek Allison and Ross Le Strange of National Acoustic Laboratories carried out the hearing aid measurements.

3 Nature of Transmission from GSM Mobile Telephones

For the GSM system the radio spectrum available for mobile-to-base (i.e. mobile telephone) transmission is between 890 and 915 MHz, and for base-to-mobile it is 935 to 960 MHz. The modulation produces 0.6 ms bursts of RF energy from each telephone transmitter at a pulse rate of 217 Hz. A number of peak power levels and equipment configurations are available for GSM mobile telephones for use within Australia. These include a 2 watt hand held unit and an 8 watt transportable unit. When due account is taken of the pulsed nature of the transmissions, the corresponding average power levels are 0.25 watt and 1 watt respectively.

The peak RF field strengths close to the antenna of the mobile telephone can be quite high. At 10 cm from an 8W transportable unit a peak RF field of 70-80 V/m has been measured.

The GSM system is a pulsed system with a higher peak power than the present analog mobile telephone system. This makes the GSM

system much more likely to cause interference into electronic equipment which is apparently not affected by analog RF fields. Obviously the potential for interference depends on the number of GSM mobile telephones in use in the community and this is unlikely to be very high in the next few years.

4 Interference to Hearing Aids

Interference to a hearing aid is considerable, the amount depending on the details of its design. Considerable concern is felt by the European Hearing Instrument Manufacturers Association as the new system is being implemented in all European countries. The Australian Telecommunications Authority, Austel is embarking on an investigation into "emerging technologies for the delivery of wireless personal communications".

The interference from one transmitter is heard in the hearing aid as a constant, distinctive buzzing sound while the telephone is transmitting nearby. Figure 1 shows a typical frequency spectrum of the output of a hearing aid with interference, which occurs across the useable range from 200 to over 5000 Hz.

Hearing aids from all manufacturers will be similarly prone to this interference.

5 Description of Measurements - Sensitivity of the Hearing Aids to the Interfering RF Signal

a **Aim:** To measure how the effect of the interference varies with the peak RF field strength, so that useful predictions could be made about the effect on hearing aids in proximity to these telephone transmitters. This was done by:-

- i Measuring the output of the aids subjected to varying RF field strengths, and
- ii Subjectively comparing the interfering output with a sound of known intensity.

b Method:

- i The hearing aids were placed in a known variable RF field generated by the system provided by Telecom shown in Figure 2. The sound output of the hearing aid was measured in a 2 cc coupler with a B&K 2120 Frequency Analyser set for wide band with a 100 Hz high pass filter to guard against low frequency ambient noise, refer to Figure 3.
- ii The noise floor of each aid was measured with the microphone blocked to ambient noise. The hearing aid output was then measured under a suitable range of field strengths, including that which produced an output 10 dB above the noise floor.

c Precautions:

- i The measuring microphone and acoustic 2 cc coupler are large metallic objects which alter the field strength around the hearing aids. In order to obtain reasonably

accurate field strength at the aid, the 2 cc coupler and microphone were moved away from the vicinity of the aid. A 460 mm length of 2 mm diameter Tygon tubing was necessary to couple the aids to the 2cc coupler. This changed the acoustic frequency response of the aid, an example of which is shown in Figure 4. This change of response does not invalidate the measurements for the purpose of this investigation, since the bandwidth was not reduced significantly. The peak RF field strengths were measured using the apparatus shown in Figure 2. The output of the generator was varied with its attenuator in order to adjust the RF field incident on the hearing aid under test.

- ii On rotating the aids in the RF field the received interference changed. However, for the purpose of this investigation, it was decided that the orientation which produced the most interference in the majority of aids would be used, since time was insufficient for a more extensive exploration and it is unlikely that significantly more useful information would have been obtained.
- iii The frequency response of each aid was graphed with normal acoustic termination and also with the extra tubing using a NAL 8500 system whose calibration was checked with a B&K calibrator. This shows that the aids were operating correctly.

d Tape Recordings:

- i The outputs of each aid was recorded with and without interference for subsequent subjective evaluation.
- ii Recordings were made of the output of some of the hearing aids with test speech passages of known average SPL with and without interference to ascertain what may be deemed a suitable threshold for characterising the effect of interference. It was confirmed that a useful "annoyance" threshold is the RF field strength that causes an output 10 dB above the noise floor of the hearing aid, i.e. the output without interference and when the microphone was blocked to ambient sound. Increasing levels of interference rapidly increases the level of discomfort, e.g. when the interference was increased to 20 dB above the noise floor, the effect became unacceptable, even though the accompanying speech was still intelligible.
- iii It is intended to prepare a cassette tape recording with samples of a hearing aid output with and without interference to speech.

6 Interpretation of the Results

- a Interference Threshold: Table 1 shows the threshold values obtained with the hearing aids issued by AHS. Interference when the telecoil is used is slightly different to that with the microphone.
- b Range of Interference: Table 2 gives an approximate indication of the relative distances at which the 10 dB threshold is reached from a 2 watt GSM hand-held mobile telephone, and from an 8 watt GSM Transportable mobile telephone. These are estimated from the hearing aid thresholds in Table 1, and by extrapolating from the peak RF field strength measurements over grass in Tables 3 and 4. As indicated in Tables 3 and 4, significant variations occur in field strengths depending on the immediate environment, however the estimated values rank the aids correctly and give a realistic indication of the range where interference will occur.
- c Conditions under which Interference Occurs:
- i The telephones interfere with all the hearing aids tested. A user of one of these hearing aids will not be able to use these telephones, and a hearing aid will often become useless or cause the wearer discomfort close to a telephone when it is being used. This situation is representative of currently available hearing aids. It will be noticed that the IT312 has the least interference. An explanation is given below.
 - ii Behind-the-Ear hearing aids experience more interference than In-the-Ear aids.
 - iii Hearing aids such as the VHK are likely to be unusable even several metres away from either the hand-held or the transportable telephones.

7 Interfering Mechanism

- a From the experimental work we can say that the interference occurs at the most sensitive part of the hearing aid amplifier, where the RF field induces signals in the wires connected to the microphone or the telecoil and detected (rectified) by the transistor input, and possibly by the output of the microphone which has a simple buffer amplifier. This mechanism applies in high gain audio amplifiers such as those used in public address systems that are subject to AM radio and television transmissions. These are normally shielded from this interference and the input shorted by a small capacitor to eliminate the problem.
- b The higher peak pulses of RF power radiated and the close proximity to the hearing aids where they will normally be used, combine to make this interference more severe than the above cases.
- c Sometimes a small capacitor is used shunting the amplifier input to prevent RF signals being detected and heard by the wearer. The Calaid Sonata has a small capacitor, but is not

close to either the amplifier chip or the microphone. The Serenade, VLK and VHK/MK do not. This explains the lower threshold RF field strengths of the V aids. The new IT312 has much shorter microphone leads than the previous ITE hearing aids Sonata and Serenade, since the microphone is solidly mounted next to the amplifier board. The lower sensitivity to interference is consistent with the above mechanism.

8 Remedies

a Possible Approaches

i **Filtering:** The shunt capacitor is a simple filter. It should be placed physically very near the amplifier integrated circuit chip with very short wires. It may also be necessary to place one across the microphone output at the microphone. The capacitors are restricted by their affect on the circuit operation as well as taking up valuable space. By using a small ferrite inductor in series with the microphone leads in conjunction with the shunt capacitor, it may be possible to eliminate interference.

ii **Shielding:** Complete shielding of the whole hearing aid with a conductive sheath will eliminate the interference, but is likely to be impractical. Suitable methods include thin metallic coating on the inside of the case parts, impregnation of the plastic with fine conducting particles and using a "metallic" paint. It may reduce the sensitivity of a telecoil if fitted. It is likely to be impossible to completely shield the aid, and connecting leads for audio input and induction pickup coil (telecoil) that are not shielded would present problems.

iii **Feasibility:** It is not known now if these or other remedies will work and to what extent they may work.

iv **Restricting the use of the new GSM mobile telephones** will prevent interference, but would probably make the GSM system useless.

b **Existing Hearing Aids:** Changes to the large number of existing hearing aids has the following problems:

i It may be logistically difficult, if not impractical.

ii **Feasible modifications** are likely to be of minimal effectiveness because of the difficulty in applying effective remedial treatments to an existing product.

iii **Modifications to existing aids** may be very expensive.

c **New Hearing Aids:** If effective means to prevent interference are developed, they could be designed into new hearing aids.

9 Conclusion

a It is likely that hearing aid users will be inconvenienced to some extent very soon after the new telephones are

introduced.

- b Widespread use of the new GSM mobile telephones may make existing hearing aids useless for much of the time.
- c Unless there is a realistic design remedy, new hearing aids will be affected, but possibly to a lesser extent, since partial remedies seem to be possible.
- d Co-operative work to investigate effective design solutions is necessary, to establish if they can be developed.
- e Monitoring the uptake of the GSM service and reports of interference to hearing aid users to gauge the extent of the problem in the short term and in the longer term undertake a co-operative programme to find practical and cost effective solutions.

10 Recommendation

- a Make this problem known through:
 - i Austel,
 - ii Hearing Aid user Groups,
 - iii Hearing Aid manufacturers,
 - iv Relevant government departments,
- b Initiate co-operative work to look for a suitable design solution,
- c Keep the above mentioned bodies informed about the extent of the GSM system and inform GSM mobile telephone users about the interference that may be caused to hearing aid users.

11 References

- a European Hearing Instrument Manufacturers Association, "Implications of GSM for the hearing handicapped", Bosstraat 135, B1780 Wommel, Belgium, Tel 32-2-460 2284, Fac. 32-2-460 42449.
- b AUSTEL, "Discussion Paper: Wireless Personal Communication Services", Mobile Equipment Standards Section, AUSTEL, P.O. Box 7443, St Kilda Road, Melbourne. Victoria, 3004

Table 1 RF Field Strength for Noticeable Interference to Hearing Aids (From measurements of AHS Hearing Aids)

Hearing Aid	Microphone Switched In			Telecoil Switched In		
	RF Field (Volts/metre)	Hearing Aid Output (dB SPL)	dB above Noise (no RF)	Threshold (Volts/metre)	Hearing Aid Output (dB SPL)	dB above Noise (no RF)

Behind-the-Ear Hearing Aids

PPSCL	3.1	85.5	9.5	3.1	67.0	5.0
PPSC	2.8	94.5	9.5	4.9	87.0	10.0
VHK	0.7	89.5	9.5	0.4	77.0	12.0
VLA	1.6	62.0	12.0	2.0	59.0	12.0
PPCLA	3.1	85.0	11.0	3.1	74.5	9.5

In-the-Ear Hearing Aids

JLFR Sonata	9.4	69.5	10.0
S Serenade	4.9	66.0	10.5
IT312 NAL-Fhocx	32.3	78.0	9.5

Table 2 Threshold Distances for Noticeable Interference to Hearing Aids (Calculated from measured aid sensitivity and approximate field strengths near the telephones)

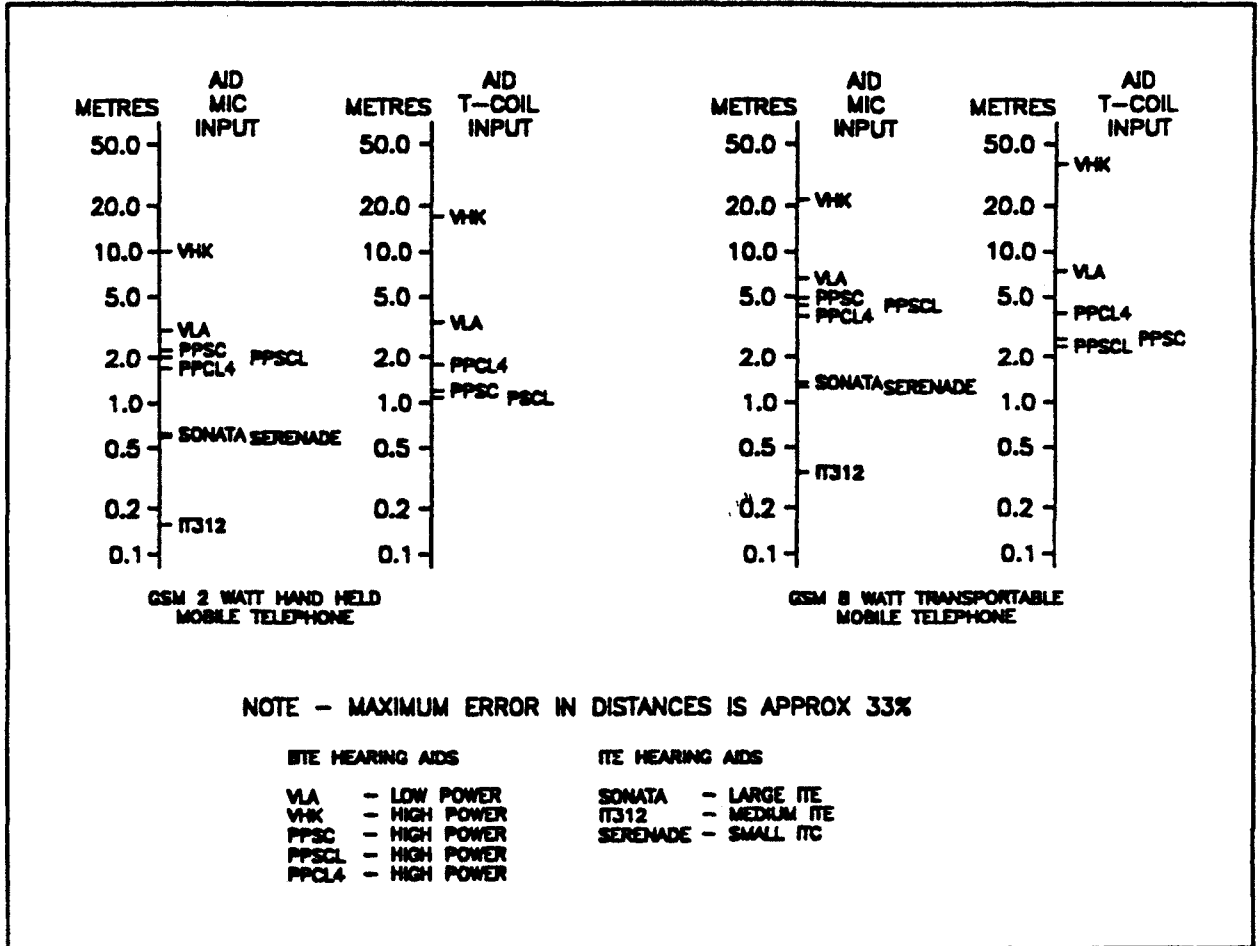

Table 3 Measured Field Strengths Near GSM 8 Watt Transportable Mobile Telephone, (Source Telecom Research Laboratories personal communication)

Distance (m)	TEST 1 - Outside Over Grass	TEST 2 - Inside Lab.	TEST 3 - Inside Lab. with Absorbers
	Field Strength (V/m)	Field Strength (V/m)	Field Strength (V/m)
0.1	81.8	76.3	
0.2	53.4	51.6	
0.3	34.9	36.9	
0.4	27.4	30.7	
0.5	21.8	23.3	25.0
1.0	12.0	12.0	12.4
1.5		10.1	
2.0	5.7	6.2	5.9
2.5		9.6	
3.0	4.0	7.5	4.1
3.5		3.4	
4.0	2.8	5.8	
4.5			
5.0	2.6		

Table 4 Measured Field Strengths Near GSM 2 Watt Hand-Held Mobile Telephone, (Source Telecom Research Laboratories personal communication)

Distance (m)	TEST 1 - Outside Over Grass	TEST 2 - Inside Lab.	TEST 3 - Inside Lab. with Absorbers
	Field Strength (V/m)	Field Strength (V/m)	Field Strength (V/m)
0.1	41.9	38.7	
0.2	28.7	27.1	
0.25	24.1		
0.3	20.8	21.3	
0.4	15.0	16.3	
0.5	13.1	14.7	
1.0	5.5	7.1	6.2
1.5	3.4	6.4	
2.0	2.4	4.1	3.0
2.5	1.7	3.5	
3.0	1.7	4.3	4.3
3.5	1.1	4.0	
4.0	1.2	2.7	
5.0	0.8		

Figure 1 Sample Frequency Spectrum of a Hearing Aid Output with Interference

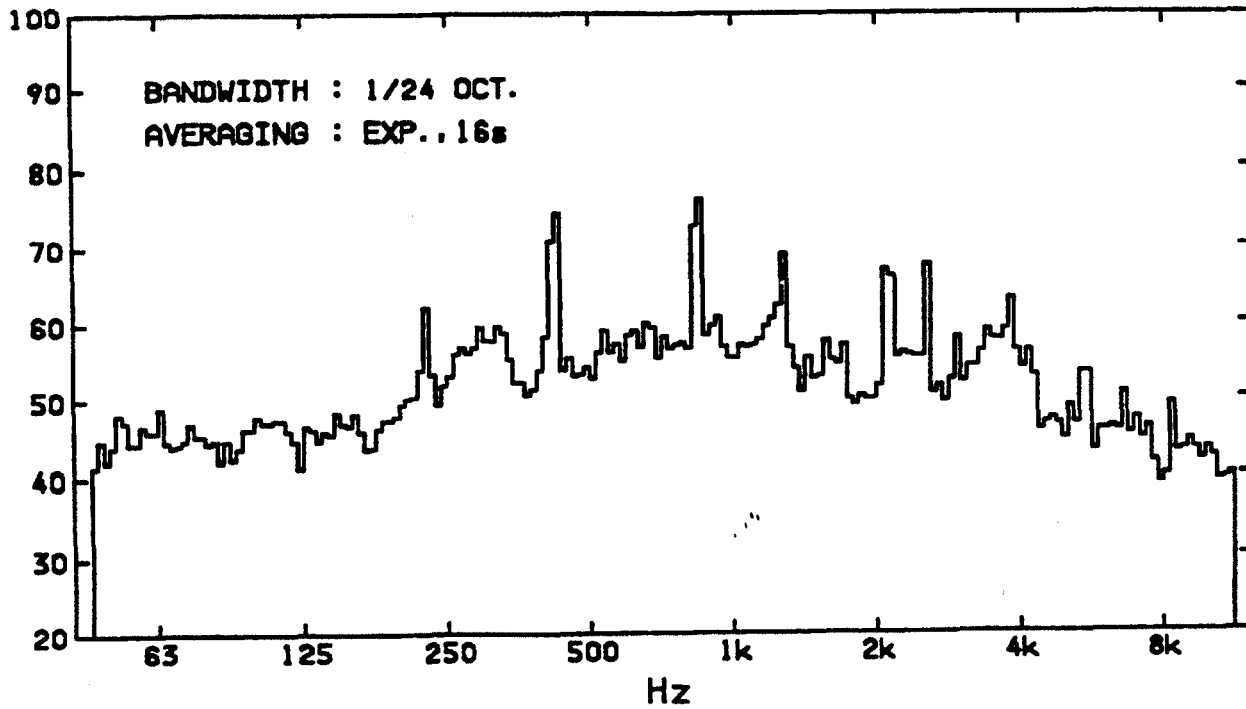

Figure 2 GSM Transmitter - Test Set-Up for Simulating Transmission

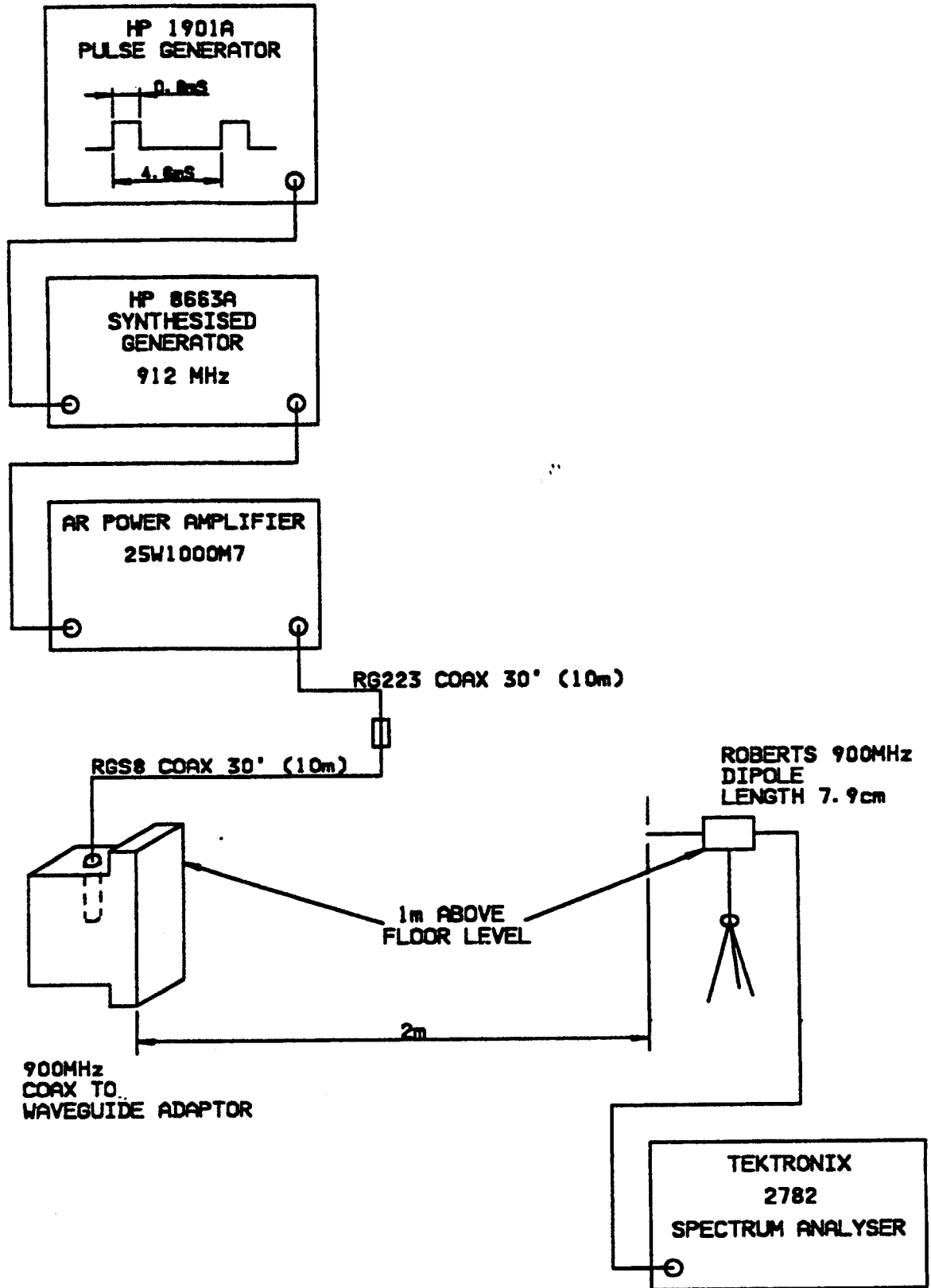

Figure 3 Hearing Aid Output with an Interfering Signal - Test Set-Up

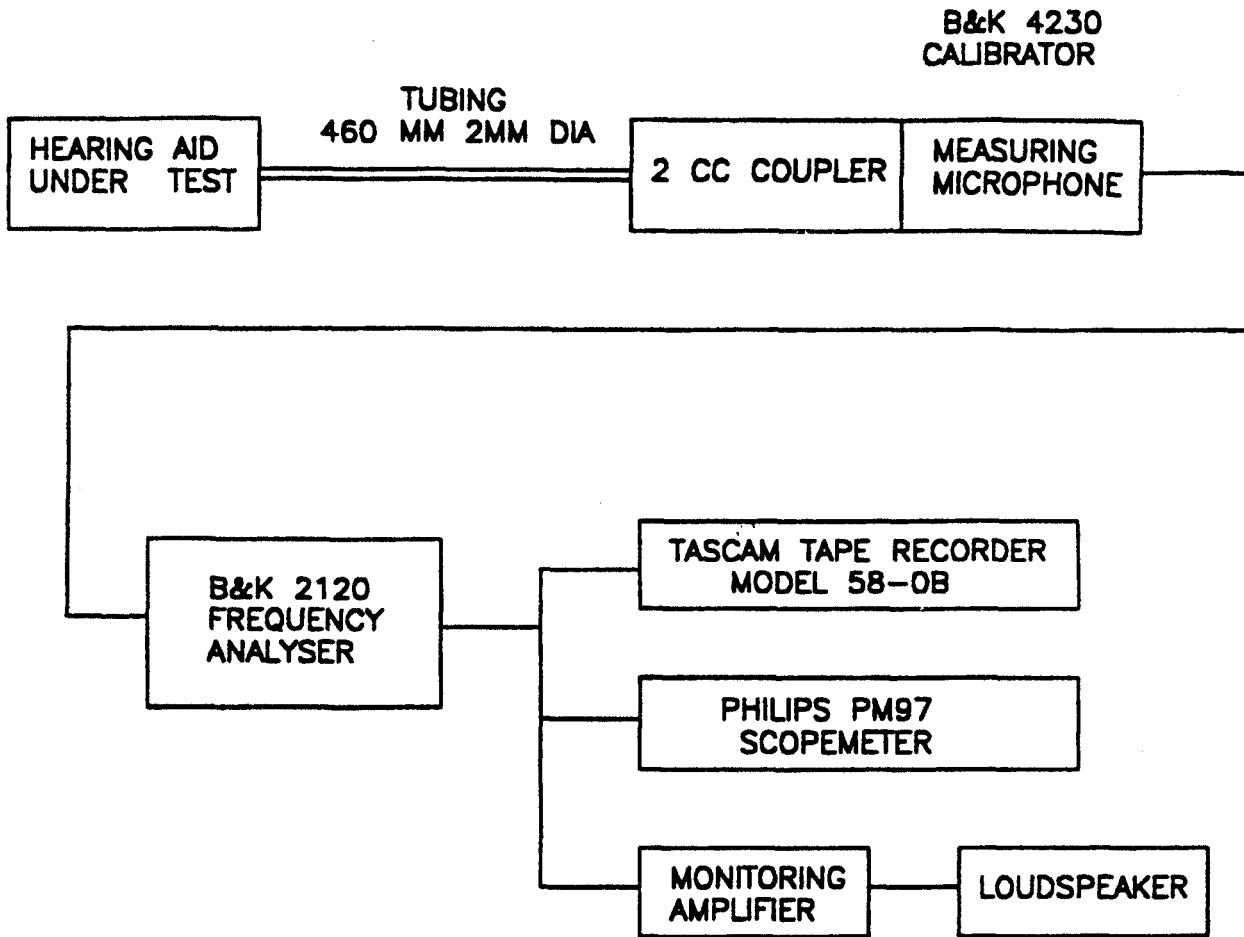
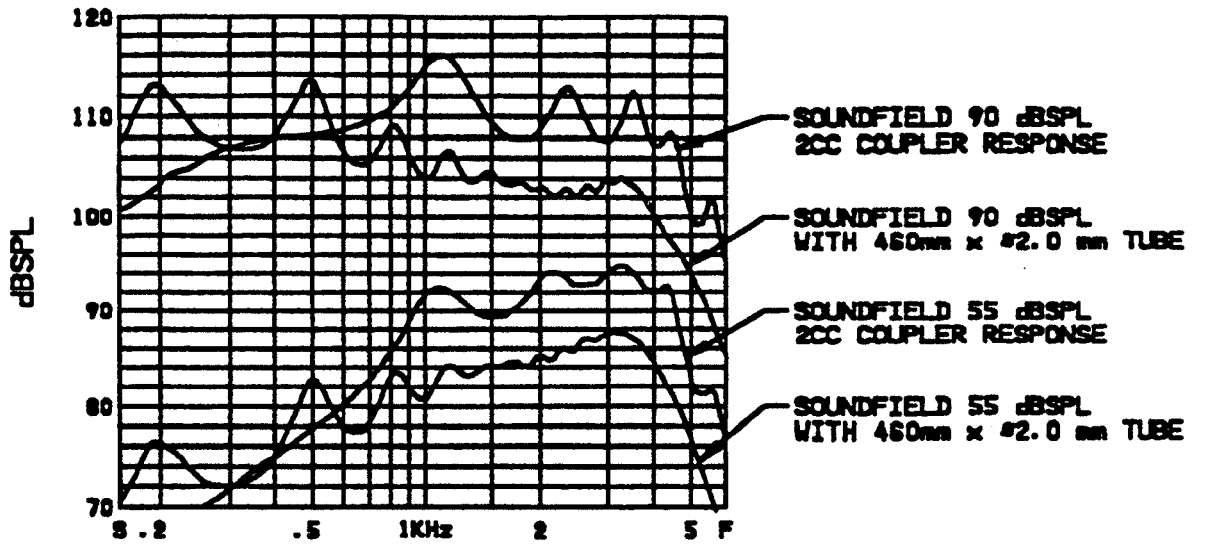

Figure 4 Sample Acoustic Frequency Response of Hearing Aid, with and without extended tube to 2cc coupler acoustic load.



Annex G: Studies on interference from GSM terminals to the fixed network telephone equipment

This annex includes four studies on the interference from GSM terminals to the fixed network telephone equipment. The studies are made by BTL, France Telecom, CSELT/SIP and Televerkets Forskningsinstitut.

ETSI STC SMG2 No.5
9th - 12th March 1993
Brighton, UK

T.Doc 52/93 Rev 1

Source : BTL (UK)

Subject : EMC Considerations for fixed telephones in the UK

The table below shows the results of testing the immunity of various fixed telephones and PBX equipment (both analogue and digital) available in the UK. The testing was conducted at 3V/m and 10V/m using a simulated GSM test signal as the interference.

Mid-range Carrier- Frequency (MHz)	Modulation Type	Maximum Field- Strength (V/m)	R E S U L T											
			1a	1b	1b	2	3	4a	4b	4c	5	6		
866	CW	3
"	"	10
"	AM	3	F	F	F	F
"	"	10
"	CT2	3	F	F
"	"	10	F
910	CW	3
"	"	10
"	AM	3	F	F	F
"	"	10	F
"	CT2	3	.	.	F
"	"	10
955	CW	3
"	"	10
"	AM	3	F	F	F
"	"	10
"	CT2	3	F	.	F
"	"	10

It can be seen that the vast majority of telephones and telephone equipment tested is not susceptible at even 10V/m. This field strength will be present at a distance of 1m from a Class 4 mobile. Therefore, although it is recognised that interference from GSM mobiles to fixed telephones is an issue, due to the UK immunity standard for fixed telephones, this is not considered a major problem in the UK.

Key :-

F Failed test
- Passed test
. Not tested

Where failure criteria was -40dBPa.

- 1 PBX with various terminal equipment
- 2 Payphone
- 3 MUX/DEMUX equipment
- 4 PBX with various terminal equipment
- 5 ISDN equipment
- 6 Line terminal equipment

Source: **France Telecom**

Subject: **EMC considerations for fixed telephones in France**

1. Introduction

Mobile GSM portable terminals have been identified in France as primary sources of interference to fixed telephones, electro acoustical devices and video displays. As these were, at first, subjective results, testing of the immunity of various fixed telephones at close distance of a programmable GSM portable equipment was undertaken.

2. Experiments

A commercially available GSM unit was used for these tests, with a specific test SIM card. This card transforms the terminal into a programmable unit with the possibility of choosing, the frequency (channel), the peak power and the sequence as well as many other parameters.

a) Frequency and field strength:

The testing was conducted with field strength of 10 V/m and 3 V/m and 892 MHz frequency (by using two levels of power at the same distance of the terminal : one with a peak power of 8 Watts, the other with a peak power of about 2 Watts)

b) Performance criteria:

A very important point concerning the immunity of the telephone is the performance criteria. For fixed telephones or acoustical devices, the main performance criteria is the fact that no noise should be listened to, caused by the GSM TDMA pulses (217 Hz and harmonics) occurring by audio rectification in the IC amplifiers, or non linear circuits of the electroacoustical devices.

In addition, for fixed telephones or PABXs, the audio rectification signal should not be sent in differential mode along the telephone line. It means that the correspondent should not listen to the demodulated signals occurring by the presence of GSM unit close to the telephone at the other end.

Two criteria are defined in France for the telephones concerning their immunity to the radiated or conducted interference.

First, the demodulated RF signal should not be sent on the telephone line with a power level higher than - 50 dBm in the audio transmission band, on a 600 Ohms impedance telephone line with a differential mode.

Second, no noise higher than 50 dBa weighted, should be listened in the earphone or in the audiotransducers

These parameters characterize the performance criteria in the presence of RF field strength and provide a generally accepted representation of the effect of good performance. Of course, no interruption of call, neither loss of stored numbers in memory should occur

The appendix show the test description and detailed results on these immunity tests.

3. Results and conclusion

With these parameters, it has been shown that :

Today, no telephone analog equipment or audio terminal can comply with a 10 V/m GSM type, fieldstrength

although EMC standards are mandatory in the country (1 or 3 V/m compliance is accepted with the old IEC 801-3 frequency limits 30 to 500 MHz plus AM modulation 1 kHz 80 %) and 3 on 6 fixed telephone equipment will comply with 3 V/m immunity requirements.

It has to be mentioned that no loss of ongoing call, no dialing error , no loss of stored information occurred, but the demodulated level was unacceptable .

Most of ETSI or CENELEC standards on EMC state only that no loss of ongoing call, no dialing error, no loss of stored data is the performance criteria , it is proved not sufficient to assess the electromagnetic compatibility.

Even , if it could be considered that if in the future, a specific standard from the CENELEC concerning telephone could include such immunity requirements, the GSM interference potential today is to be taken into account because there are millions of telephone equipment that are susceptible to close distance GSM emissions .

We consider that if a 8 W portable GSM terminal is used, the maximum distance of potential interference is typically about 10 meters maximum, and if a 2 Watts GSM terminal is used this distance is reduced to a maximum of 5 meters.

In any case, we recommend that for non car-embarked GSM terminals, the radiated power should not be higher than 2 Watts peak power.

A contribution on this subject concerning a specific EMC standard of telephone and PABX equipment should be sent to CENELEC.

It is considered that interference from GSM terminals to fixed telephones and PABX is an issue through the European community, even if body worn audio and health electronic equipment is a major and much more important issue.

Appendix

1.Measurement of the immunity of fixed telephone equipment

In order to evaluate the immunity of electronic telephones to the emission of GSM terminals, two types of experiments were carried out:

First, a subjective test in a secretary office, the second is a formal immunity test in a semi-anechoic room .

1.1.Subjective test

In an ordinary secretary office, many different fixed telephones were installed . We asked to various people present there to call with these telephones. An operator using a GSM portable 8 Watts peak terminal made a call at the same time.

As soon as the first phase of GSM search occurred, all the telephones installed in the office were more or less highly disturbed by the presence of the GSM emission by superimposing a noise on the telephone audio band.

For the people who were the closer of the GSM terminal, the noise was not tolerable (1 m typically) and as the people were farther, the communication was made possible.

Typically, at a distance higher of 5 meters, the communication with the GSM did not disturb the other telephones.

1.2.Immunity test

The same GSM terminal was used in a semi anechoic Faraday cage and at a distance of 1 meters some fixed telephone terminals were set up with a test fixture in order to evaluate the demodulated audio noise provided by audio rectification on the earphone and on the telephone line .

To avoid any coupling with the field strength , the measurement equipment was put outside the semi-anechoic room.

The field strength was also monitored to make a correlation between the output power, the field strength and the demodulated output.

1.3.RESULTS

	GSM Output Power (W)	GSM Output Power (W)	GSM Output Power (W)	GSM Output Power (W)	GSM Output Power (W)	GSM Output Power (W)
	0 No emission	8	2	0 No emission	8	2
TELEPHONE	Demodulated audio level (DM) (dBm op/ 600)	Demodulated audio level (DM) (dBm op/600)	Demodulated audio level (DM) (dBm op/600)	Audio level (dBA)	Audio level (dBA)	Audio level (dBA)
T1	-73	-30	-40	41	71	62
T2	-73	-48	-68	38	70	60
T3	-73	-40	-62	43	79	69
T4	-78	-48	-63	38	78	64
T5	-73	-84	-67	38	80	87
T6	-69	-43	-63	38	68	84
T7	-74	-38	-48	37	80	70

The limits are -50 dBmop/600 Ohms of demodulated level along the line differential mode (DM),and typically 50 dBA on acoustic level at the earphone

Source: CSELT / SIP

EMC considerations for fixed telephones in Italy

1 - Introduction

Some SMG2 documents have been produced up to now on the potential disturbances of GSM transmitters on fixed telephones in UK (SMG2 Tdoc. 52/93), in France (SMG2 Tdoc. 89/93) and in Norway (SMG2 Tdoc. 100/93).

This document adds some information to the problem, by discussing the results of some tests performed in Italy using a set of fixed telephones interfered by GSM emissions at different power.

2 - Measurement procedure

The immunity of fixed telephones to the interference of GSM emissions was measured in two different environments: a GHz-TEM cell and a properly equipped flat roof.

2.1 - Generation of the GSM interference

Most experiments were carried out using an interfering signal produced by a transportable GSM mobile equipment communicating with a base station at a constant power level (since the power control function of the GSM was not active during the test). A portion of the GSM signal was split by a 20 dB directional coupler and sent to the radiating antenna through an RF power amplifier. The signal power level at the antenna was regulated by a variable attenuator and checked by means of a peak power meter.

Other experiments were also performed by emulating the GSM emission through a sine-wave (generated by means of a frequency synthesiser) modulated by pulses (produced by an arbitrary waveform generator). Two modulating signals were considered: a pulse reproducing the GSM frame (repetition rate equal to 216.6 Hz, duty cycle of 1/8, guard time equivalent to that of GSM bursts) and a 200 Hz square wave with a duty cycle of 50%.

2.2 - Performance criteria for the immunity tests

The following parameters were used in order to evaluate the immunity of the fixed telephone to radiated or conducted interferences.

- Noise rejected along the line (expressed in dBmop on 600Ω), measured by a psophometer and weighted by CCITT curve. A maximum value of -50 dBmop is consistent with the current trend in CENELEC standards.
- Level of the acoustic disturbance (expressed in dB-SPL, weighted with the A curve) listened by an artificial ear coupled with the handset. Even if no limits are currently specified, on the basis of laboratory experience, a level of 60 dB-SPL can be considered clearly audible, while a level of 70 dB-SPL gives trouble to the conversation.

2.3 - Test setup

Formal tests were carried out in a GHz-TEM cell using the block diagram shown in fig. 1; the devices under test were interfered by a vertically-polarised plane-wave produced by a radiating element fed by the GSM test signal. The acoustic disturbance was measured by an audio analyser connected to an artificial ear, while the noise rejected along the line was measured by a psophometer. A preliminary calibration of the electrical field strength was performed by using a continuous wave signal, whose equivalence with the level of the GSM stimulus was established by means of a peak power meter. Measurement have been performed for electrical field strength of 3, 6, 10 and 15 V/m.

The correspondence between the electrical field measured in the GHz-TEM cell and the power transmitted by a GSM mobile was verified separately on a properly equipped flat roof covered with a metal plating and supplied with panels of absorbing material, which attenuate the scattering from other directions. It has been verified that the electrical field values measured at one meter distance from the calibrated dipole had a good correspondence with the expected values of the transmitted power (~6 V/m for 0.8 W, ~10 V/m for 2 W, ~16 V/m for 5 W and ~20 V/m for 8 W).

The equipped flat roof was also used for informal tests: the devices under test were placed on a wooden and plastic support. Some experiments were carried out with the same stimuli as those used in the GHz-TEM cell, transmitted by a calibrated electric dipole mounted on a tripod. Other informal experiments were performed by a man bringing the active GSM transmitters (hand held and portable) directly near the device under test. The disturbances on the fixed telephones were measured in the same way as in the GHz-TEM cell case.

3 - Test results

A certain number of telephones commonly used in the Italian public network were tested both using the GHz-TEM cell and the equipped flat roof.

As far as the GHz-TEM cell is concerned, figs. 2 and 3 show respectively the noise rejected along the line and the level of the acoustic disturbance vs. the electrical field strength of the GSM interferer. Telephones labelled as T1, T2, T6, T7 are samples produced by different manufacturers of a

very common model in Italy. The wide spread between the curves (more than 10 dB) can be justified by the different sensitivity of the electronic devices put on the circuit boards of the telephones, by a slightly different arrangement of the device under test and of its wires and by the uncertainty of the measuring equipment. The shape of the telephone labelled as T3 looks like that of the previous ones, but its circuits are shielded by a metallic box, making it suitable for strong electromagnetic interference environments. Its immunity (rejected noise lower than -50 dBmop and acoustic level of the order of 50 dB-SPL) is higher than that of the previous models. An immunity of the same order of magnitude was also achieved by a rugged and compact model (labelled T5) without any peculiar shielding. The lowest immunity to the radiation was instead obtained by the model labelled T4, which uses more sophisticated electronics for the automatic answering function.

It is worthwhile noting that the sensitivity to the GSM interference was caused in all cases by the electronic circuitry of the fixed telephones; in fact the tests performed on an old electro-mechanical analogue telephone did not detect any kind of disturbance, even with very high interfering transmitted power (up to 20 W).

The immunity of two selected telephones (T1 and T3) to the GSM interference was also compared with the immunity to different stimuli (GSM-like emulated signal and sine-wave modulated by a 200 Hz square-wave). The results of the comparison are shown in figs. 4 and 5 respectively for the noise rejected along the line and the level of the acoustic disturbance. Note that the spread between the curves is narrow, even if the true-GSM case results slightly worse.

For the same selected telephones, figs. 6 and 7 compare the immunity parameters (noise rejected along the line and level of the acoustic disturbance) measured in the GHz-TEM cell with those measured on the roof. The levels of the electric field measured in the GHz-TEM cell have been translated to power values in order to use the same scales for the two environments. The measurements on the roof have been performed with the dipole vertically and horizontally polarised and with the telephone kept vertical and horizontal, 1 m far from the dipole. The spread between the curves is wide (more than 10 dB), showing that the position of the interferer is crucial. The closest results between the two environments have been obtained when using the same physical conditions (telephone put in horizontal position and radiating antenna with vertical polarisation), while the worst results have been detected when putting the telephone in vertical position and using a radiating antenna with horizontal polarisation, which, on the other hand, is a very unusual arrangement.

4 - Conclusions

From the performed measurements, it results that the disturbances on the fixed telephones are due to the impulse shape of the TDMA GSM transmission processed by the electronic circuitry of such telephones. Therefore, only the old electro-mechanical analogue telephones are immune from the GSM interference, while all the other current equipment is susceptible to close distance GSM emissions, showing a strong dependence from the power of such an emission.

Simple and reliable measurements done with pulsed sine-waves give immunity results quite similar to the true-GSM case. This measurement technique can therefore be proposed as an effective alternative for the immunity tests of the telephones when only low cost, general purpose instrumentation is available (for instance for telephone manufacturers).

Out of the tested fixed telephones, just an RF-shielded model and another with a very compact structure resulted complying with immunity requirements up to 6 V/m GSM field strength (that is 0.8 W GSM emission at 1 m distance), while some models did not even comply with 3 V/m (i.e. 0.8 W GSM emission at 2 m distance).

The recent decisions made in SMG#7 to leave just the two lowest classes for GSM hand-held units (0.8 W and 2 W) and to assign the remaining two classes (5 W and 8 W) to the vehicle/portable mobiles are then also supported by the above considerations.

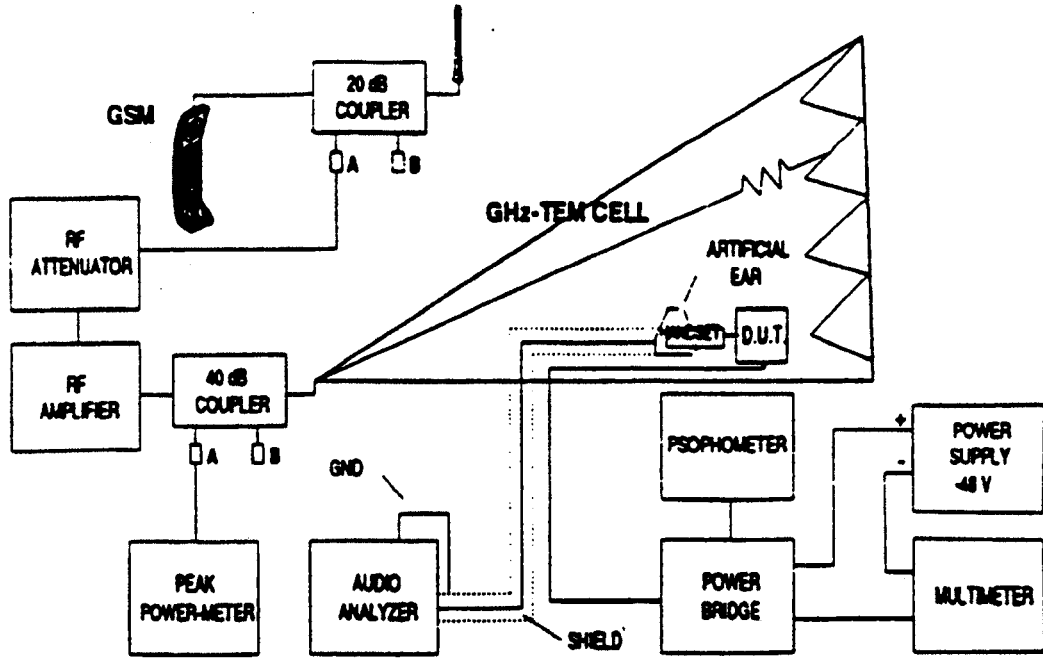

Fig. 1 Representation of the experimental setup for the measurements in the GHz-TEM Cell

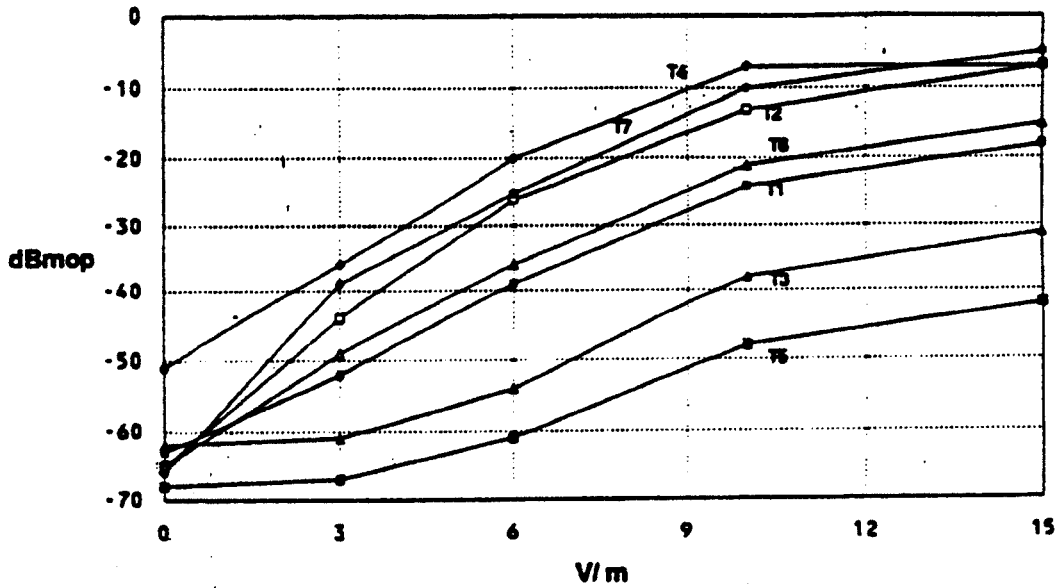

Fig. 2 Rejected noise along the line for the measured telephones in the GHz-TEM cell with the GSM signal.

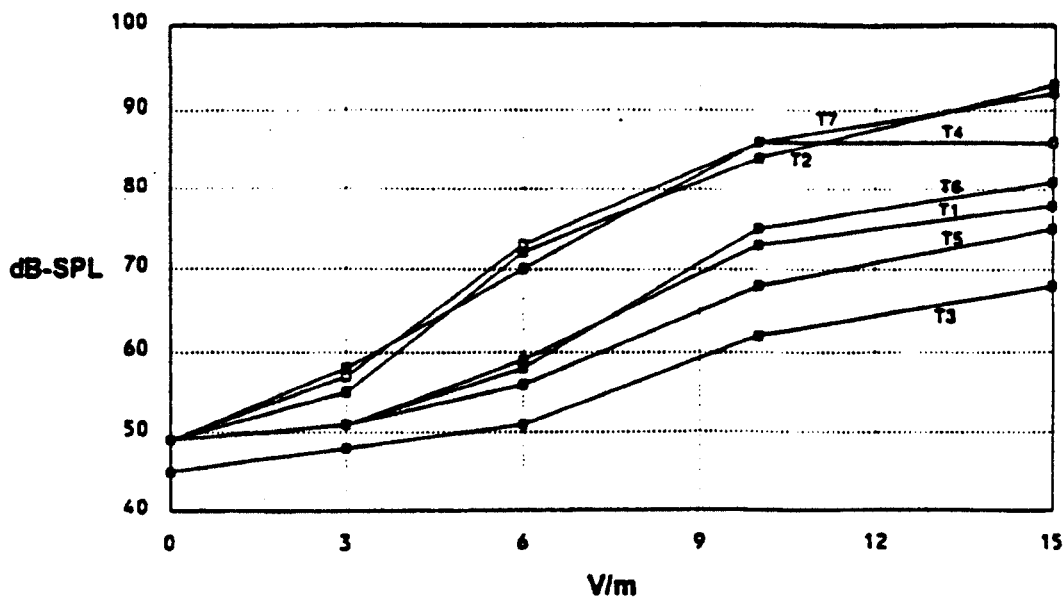

Fig. 3 Level of the acoustic disturbance for the measured telephones in the GHz-TEM cell with the GSM signal.

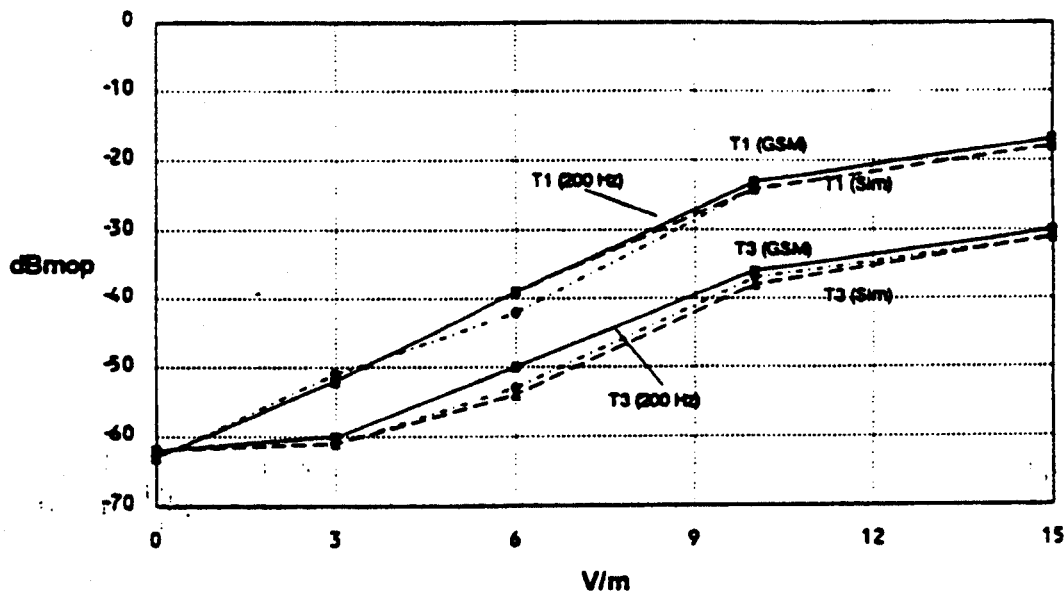

Fig. 4 Rejected noise along the line for two samples of telephones in the GHz-TEM cell with the GSM signal (straight line), the GSM pulse simulation and the 200 Hz square wave pulse modulation (dotted lines).

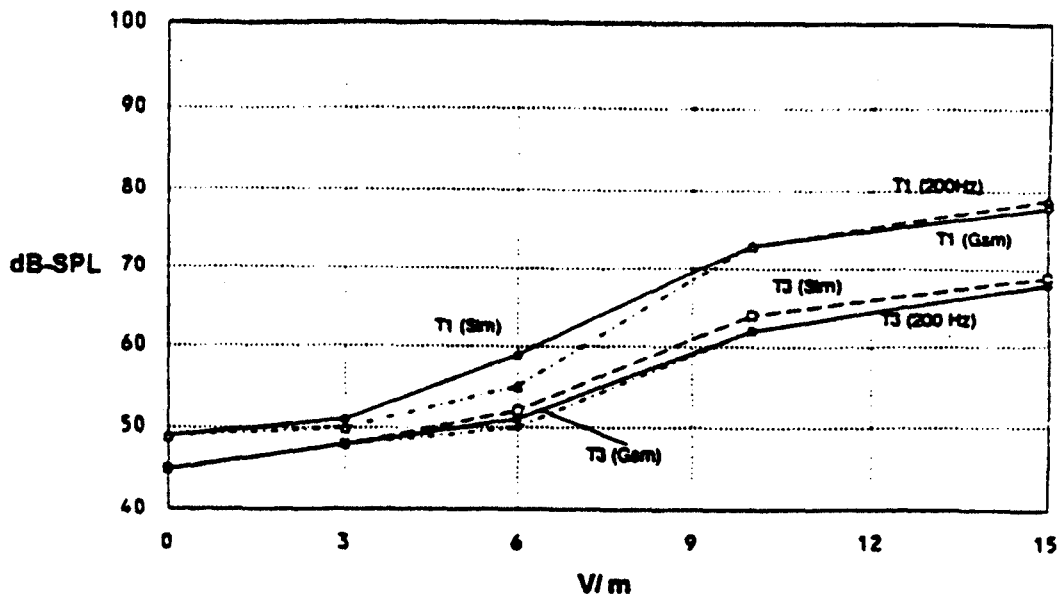

Fig. 5 Level of the acoustic disturbance for for two samples of telephones in the GHz-TEM cell with the GSM signal (straight line), the GSM pulse simulation and the 200 Hz square wave pulse modulation (dotted lines).

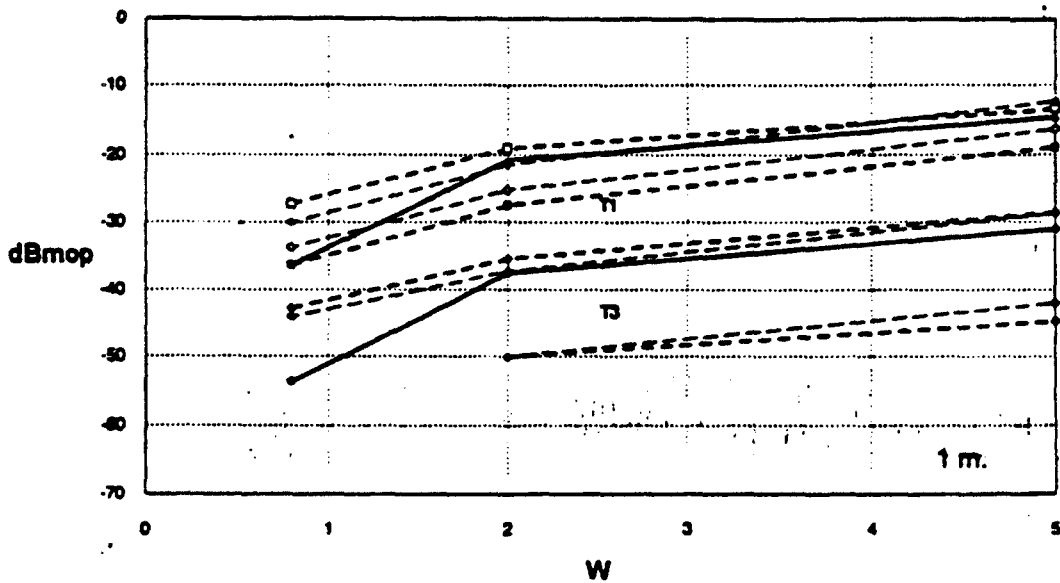

Fig. 6 Rejected noise along the line for two samples of telephones in the GHz-TEM cell with the GSM signal (straight line) and in the roof environment for various antenna polarisations and phone positions (dotted lines).

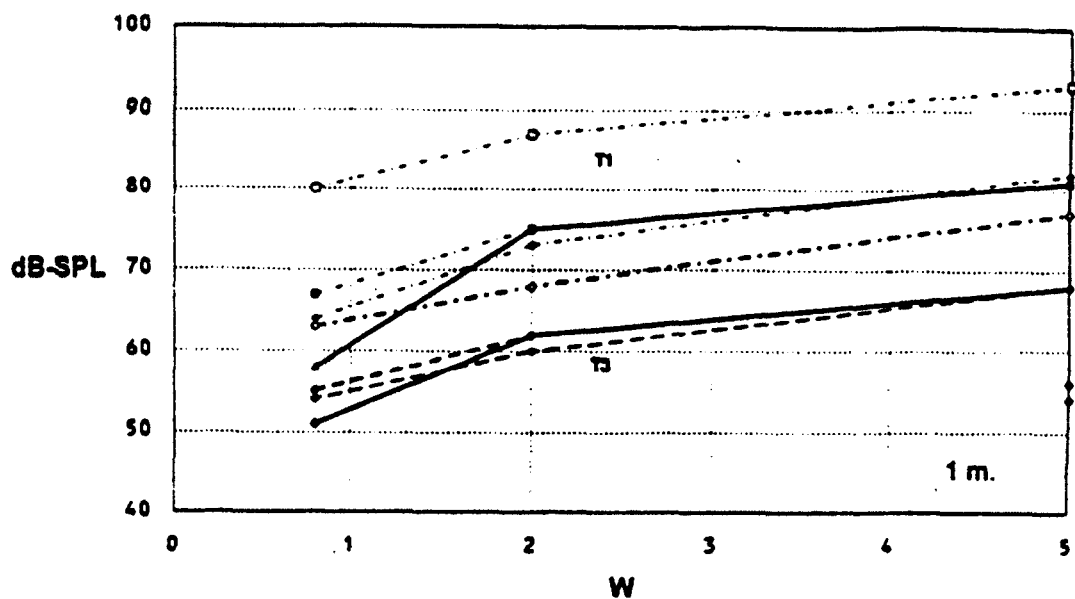

Fig. 7 Level of the acoustic disturbance for two samples of telephones in the GHz-TEM cell with the GSM signal (straight line) and in the roof environment for various antenna polarisations and phone positions (dotted lines).

TF Televerkets Forskningsinstitutt

Tittel Interferens fra TDMA-strukturene i digital mobilkommunikasjon på PSTN	TF-rapport R 40/92 ISBN 82-423-0230-8 ISSN Prosjekt nr Innsatsområde Mobilkommunikasjon
Forfattere Egil Hauger	Tilgjengelighet Åpen Antall sider 28 Dato 921006
Emneord EMC TDMA Mobilkommunikasjon	
Sammendrag Rapporten tar for seg TDMA - Time Division Multiple Access - strukturen i GSM og DECT systemene og påpeker faren for hørbar interferens i elektronisk utstyr med audio-utgang. Det er foretatt interferens måling på 12 godkjente telefonapparater og resultatene viser en meget stor spredning i immuniteten. GSM-systemet vil gi sjenerende interferens i mange av telefonene på flere meters avstand.	
Title Interference from the TDMA structure in digital mobile communication to PSTN	
Abstract The report deals with the TDMA - Time Division Multiple Access - structure in the GSM and DECT systems and pays attention to the risk of audible interference in electronic devices with audio output. For 12 type approved analog PSTN telephone sets, the interference has been measured and the results show a great variation in immunity level. The GSM system will give rise to harmful interference in many of the examined telephone sets for a distance of many metres.	

© Teledirektoratets forskningsavdeling 1992

Det må ikke kopieres fra denne rapport utover det som er tillatt etter bestemmelsene i "Lov om opphavsrett til åndsverk", "Lov om rett til fotografi" og i "Avtale mellom staten og rettighetshavernes organisasjoner om kopiering av opphavrettslig beskyttet verk i undervisningsvirksomhet".

1 Introduction

TDMA, Time Division Multiple Access, is becoming widely used in modern digital radio, particularly for mobile communication. In this way the carrier can be shared by a number of users. In GSM, the new digital mobile communication developed by ETSI, a 900 MHz carrier is divided into 8 slots for 8 different mobile users. Each timeslot is 0.5428 ms with a repetition frequency of 217 Hz. In the remaining OFF condition when the 7 other users are on air, the 900 MHz carrier is to be below 70 dB referred to the ON condition.

From an interference point of view, this is an amplitude modulation which has the possibility to create a lot of interference in other electronic devices. Analog mobile communication such as NMT and TACS has a constant RF envelope with narrowband frequency modulation and other electronic devices are not sensitive to these RF signals.

Serious interference is mainly due to rapid changes in the envelope of the high frequency interferer and therefore all kinds of amplitude modulation of a potential interferer will increase the risk for incompatibility between systems using radio communication and other IT-equipment.

Contents

1	Introduction
2	TDMA, Demodulated frequency spectrum
3	Measurement set-up, method of measurement
4	Measurements results for GSM-TDMA structure
4.1	Consequences for PSTN user in three different interference environments
4.1.1	Office
4.1.2	Village
4.1.3	Base station surroundings
5	Measurements results for DECT-TDMA structure
6	Conclusion

Annex 1 - 15

2 TDMA, Demodulated frequency spectrum

The RF spectrum from one mobile may be like fig 1 below. This is the RF burst from a GSM mobile in the 900 MHz frequency band.

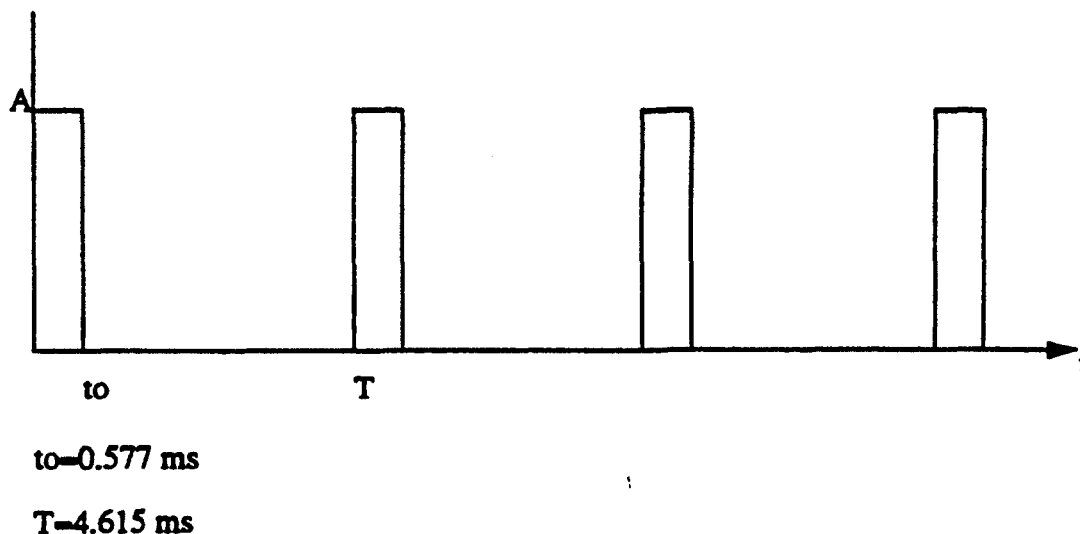

Figur 2.1: TDMA structure for GSM

The amplitude of the frequency spectrum is now given by

$$F(f) = \sum_0^{\infty} 2A \frac{t_0}{T} \left| \frac{\sin \frac{n\pi t_0}{T}}{\frac{n\pi t_0}{T}} \right| \quad (2.1)$$

The relative spectrum is shown in annex 1. As can be seen, there is a component for each 217 Hz and the spectrum has zeroes given by T/t_0 times the pulse repetition frequency.

In the same way we can calculate the TDMA spectrum for the DECT system. Here the RF pulse duration is 0.4167 ms with a pulse repetition frequency of 100 Hz. This relative frequency spectrum is given in annex 2. This TDMA structure gives a component for each 100 Hz with zeroes for each T/t_0 (= 24) times 100 Hz.

The spectrum from this TDMA structure gives most of the demodulated energy in the audio frequency band. Therefore there is a great risk that such TDMA signals give audible interference in electronic devices intended for audio output such as hearing aids and ordinary PSTN telephone set.

In this report we will give results from measurements on type approved analog PSTN sets.

3 Measurement set-up, method of measurement

For the time being there is no existing requirement for immunity of analog telephone sets. Therefore there is no standardized measurement set-up and method of measurements.

In the frequency band we are talking about, 1 GHz and above, the generation of the RF-field and how the field is coupled to the victim's electronic circuit is of greatest importance to the interference results. Our suggestion is that the measurement should be as "real life" as possible and therefore much effort is given to assure a reproduceable and realistic immunity test which gives as exact as possible the interference level the user can, in the worst case, be exposed to.

Annex 3 gives the overview of the instrument set-up in a semi-anechoic chamber. During the measurement we realized the very importance of positioning the telephone set and the transmit antenna. The telephone set was placed on a turntable for rotation 0-360 dgr and the antenna was rotated in the horizontal and vertical position in the height from 0.95 to 2.20 m.

The highest interference level occurred at an exact position of both the telephone and the antenna indicating that the RF-field was coupled to the PCB of the telephone and not induced via telephone line or handset cable. In an ordinary desk telephone where the PCB is horizontal the interference level was much higher for horizontal polarized field than for vertical, although the telephone line and the handset cable were vertical as shown on the set-up.

Now the antenna in a mobile system is foreseen to be vertical, but when using a handheld mobile set, the angle to the vertical is about 65 degrees and in practice the angle can be in the whole range from 0 to 90 degrees. For car mounted antennas, the angle should be nearly 0 degrees to the vertical, but even here the antenna may be more horizontal because of the convenient capacitive coupled window antenna. When using a one piece telephone set, the angle can of course be the same for the fixed and the mobile telephone.

The measurements are taken at a distance of 3 m from the interferer antenna to the telephone. In this frequency band the far field distance is less than 0.25 m, so you can easily calculate the interference level for any distance of interest.

The interference level was measured both at receive and transmit side of the fixed telephone. On the receive side, the interference was weighted with A-filter and on transmit side the psophometer filter was used.

Due to the high electric field, and problem of filtering to the anechoic chamber, we had to use a passive acoustic coupler with tight coupling. This tight coupling had of course some influence of the frequency response of the handset, but when using the A-filter the influence was minimized. A typical frequency response is given in annex 4 for telephone set no 8.

4 Measurements results for GSM-TDMA structure

The immunity measurements have been taken for 12 separate telephone sets, 8 ordinary desk telephones and 4 one piece, handheld, telephone sets. They are all type approved for use in the fixed telephone network in Norway.

When measuring interference noise at the receive side of the telephone, we used 1000 Hz, with -10 dBm from the fixed side as reference. The noise was then weighted with A-filter and the S/N ratio was calculated. The noise measurement at the transmit side was absolute value, weighted with psophometric filter. The results are shown in annex 5 for receive and 6 for transmit. As can be seen there is a quadratic function from RF-power to noise power. When increasing the RF-power by 3 dB, the noise increases by 6 dB. The high transmit noise level for telephone no 4 with low interference power is due to high internal noise. Below 8 watts GSM power the internal noise is dominant in this telephone.

If we use 0.8 W RF-power on 3 m distance, the S/N for the receiver for the most immune telephone set is about 60 dB and down to 7.7 dB for the most sensitive one. This extreme difference is hard to explain, but this is the consequence of the lack of requirements for field immunity. On the transmit side the same function can be seen, but there are differences in interference noise from receive to transmit side. If we refer to the same RF-power the most immune telephone has a noise level of -71 dBmp and the most sensitive one a noise level of -21.8 dBmp.

From the measured noise values for the receive side in annex 5 we can calculate the graph where the S/N ratio is given as a function of distance from the interferer. Annex 14 and 15 give the signal/noise with 0.8 W handheld and 10 W car-mounted GSM-telephone. Now we can divide the telephone sets into three groups. Set no 1, 2, 8 and 12 are the most sensitive, 5 and 7 are in the middle group, while the most immune are sets no 3, 4, 6, 9, 10 and 11.

If we accept 40 dB S/N as a minimum quality level and the interferer is a 10 W GSM telephone 10 m away from the fixed telephone, 6 of the 12 telephone sets must be rejected. They all have too high interference noise and for telephone set no 2 the car must be more than 70 m away to satisfy the fixed telephone user. However, we cannot draw the conclusion that every user of telephone no 2 is disturbed by the GSM telephone 70 m away, this is a worst case situation, but this exercise gives us an idea of the problem and indicates that sooner or later this problem will arise.

In these measurements we have always used RF-power as reference, but when talking immunity, field strength is the most commonly used criteria. If we look at the instrument set-up in annex 3 where we have a halfwave dipole 0.95 - 2.2 m above perfect reflecting ground and an RF-power of 0.8 W 900 MHz, we come up with 3.9 V/m for horizontal polarized field and 3.7 V/m for vertical field. This calculation is based on far field equation and with maximizing the height of the transmitter antenna.

If we have a quality standard of 40 dB S/N on the receive side, from the graph of annex 5 we can calculate the immunity for each of the 12 telephone sets. The best telephone has an immunity of 12.3 V/m and the most sensitive can only withstand 0.6 V/m. This 26 dB variation in immunity brings dramatic consequences in quality performances.

As mentioned earlier, the TDMA frequency spectrum has most of its energy in the audio frequency band. In annex 7 to 10 there are examples of frequency plot on the receive side for telephone no 2, 3, 5 and 8. For reference the 1000 Hz / -10 dBm tone is also plotted on

the same diagram. By comparing this measured spectrum with that of the calculated one in chapter 2, a great conformity is found. In the lowest frequency band you have lower interference values due to the electric/acoustic frequency response of the telephone and the A-filter.

4.1 Consequences for PSTN user in three different interference environments

The interference from mobile transmitters using TDMA is influenced by a great number of factors. We have the RF-power, the distance from the interferer to the victims, antenna position, additional attenuation in walls and the possibility of shadowing effects of the human body or other obstacles. The user environment is therefore divided into three different interference cases; office, village and base-station surroundings.

4.1.1 Office

In a typical office environment there is a fixed telephone in each room and when the mobile user is walking in the corridor outside, the interference distance is in the range of three meters. The RF-power from the GSM mobile may be as high as 2.0 W and down to 10 mW. The plot 5 and 6 can therefore be used without any changes. The antenna efficiency for the handheld station is in the range of 0 to -3 dB referred to dipole, so that when referring to power delivered to dipole you must take this loss into consideration.

4.1.2 Village

A village or small town is, especially in Norway, characterised by single-family houses made by wood situated near the road. In this situation the interference environment for the fixed telephone user is quite different from the office situation. The RF-power from the car mounted mobile telephone can, according to GSM specification, be up to 20 W, but when talking to mobile operators 10 W is more realistic. The interference distance from the road to the fixed telephone may be in the range of 5 - 10 m. The dry wooden walls give no additional attenuation.

If we look at a situation where a 10 W mobile is running 6 m away from the fixed telephone set, the S/N ratio can be as high as -2.3 dB when using telephone no 2. A speech quality of 40 dB S/N is obtained when the car is 73 m away. In the Norwegian requirement for fixed telephone, the internal noise to the fixed lines should be below -65 dBmp. In order to meet this requirement, the interference distance is more than 80 m.

This exercise is of course extreme in the sense that you have the worst case of interference and the fixed telephone user has the most sensitive telephone, but if you look at the great number of fixed telephones and the number of GSM mobiles which is expected in the future, the worst case will also arise.

As mentioned earlier, there is a great difference in the capability to withstand this TDMA interference. The mean value for all 12 telephone sets is 36.8 dB S/N and standard deviation 19.9 dB when the interference distance is 3 m and the RF power 0.8 W. For the transmitter the mean psophometric noise is -46.2 dBmp with standard deviation of 15.0 dB.

Using this figure for calculating the necessary interference distance we come up with 12.8 m for 40 dB S/N on the receive side and 31.4 m for -65 dBmp on the transmit side.

The conclusion for fixed telephone users in village areas is that there is a strong possibility for unacceptable TDMA interference from car mounted GSM telephones.

4.1.3 Base station surroundings

The TDMA structure of the RF signal is a function of the traffic load in the base station, but you can have the same RF burst in this direction as from the mobile. The RF power is up to 40 W for each carrier and the antenna gain may be 10 dB. If this is the case when calculating the necessary interference distance you come up with 198 m in order to meet the noise requirements on the transmit side using the mean value for the 12 telephone sets. In this situation using the highest power and high gain antenna the number of nearby fixed telephones will probably be low. A more realistic situation will be using 10 W RF power and 6 dB gain antenna. The interference distance is now 62 m for -65 dBmp on the transmit side and 25 m for 40 dB S/N on the receive side.

The base station is on the air all the time and the fixed telephone user will be exposed to this TDMA interference whenever the subscriber is calling.

For the operator there is also the possibility that the fixed telephone at the base station service center will be disturbed.

The operator of TDMA structure mobile systems must be aware of the relatively strong possibility of unwanted disturbances for the fixed subscriber in the base stations neighbourhood.

5 Measurements results for DECT-TDMA structure

The TDMA structure for DECT is somewhat different than shown in chapter 2. The pulse repetition frequency is 100 Hz giving the frequency spectrum in annex 2.

The RF power is defined to be maximum 250 mW EIRP and the interference level for telephone no 2, 5 and 8 is shown in annex 11 to 13. Comparing this interference to a GSM telephone with 0.8 W the noise is 30-40 dB lower for DECT telephone than for GSM.

This lower interference is caused by a lot of factors. The reduction of RF-power lower the noise by 10 dB, the doubling of the frequency gives 6 dB lower interference voltage causing 12 dB lower noise, and with this higher frequency the distributed capacitance on the PCB acts as a low pass filter reducing the induced interference voltage.

The potential TDMA interference from DECT into fixed telephone sets is then seen to be much lower than for GSM due to the higher frequency and the lower radiated power. This is not to say that TDMA in 2 GHz band is of no problem from an interference point of view.

6 Conclusion

As the measurements have shown there is a high interference potential from a TDMA structure mobile communication system, particularly with the high power transmitters as in the GSM system. The lack of immunity requirements in the VHF/UHF band for amplitude modulated field is a serious matter which has to be dealt with within the relevant standardizing institutions, like ETSI and CENELEC. Some considerations have been given to this subject in for instance ETSI. In a meeting in Paris 10-14 November 1990 in TC-RES a paper was presented by UK DTI - Radiocommunication Agency "THE EMC CONUNDRUM - TDMA TECHNOLOGY". A lot of measurements results from hearing aids exposed by TDMA interference are presented and the conclusions are "that the proposed generic immunity standard of 3 V/m does not offer adequate protection from radio transmitters".

But for the fixed telephones already in use there is little help in better standards for the future. The mobile system operators must be responsible and take proper action to assure the fixed subscriber a conversation free from TDMA interference also in the future. This is not an easy match, but the cost must be on the interferer and not the victim.

GSM - TDMA frequency specter

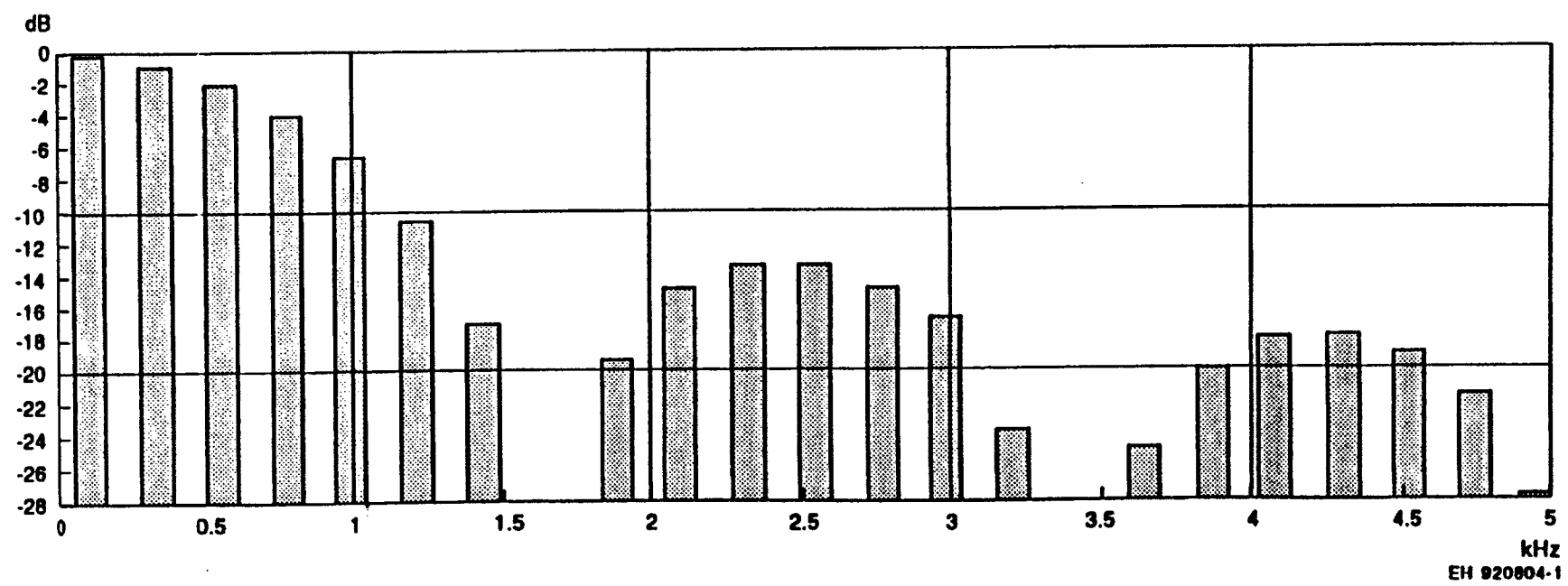

EH 920804-1

DECT - TDMA specter

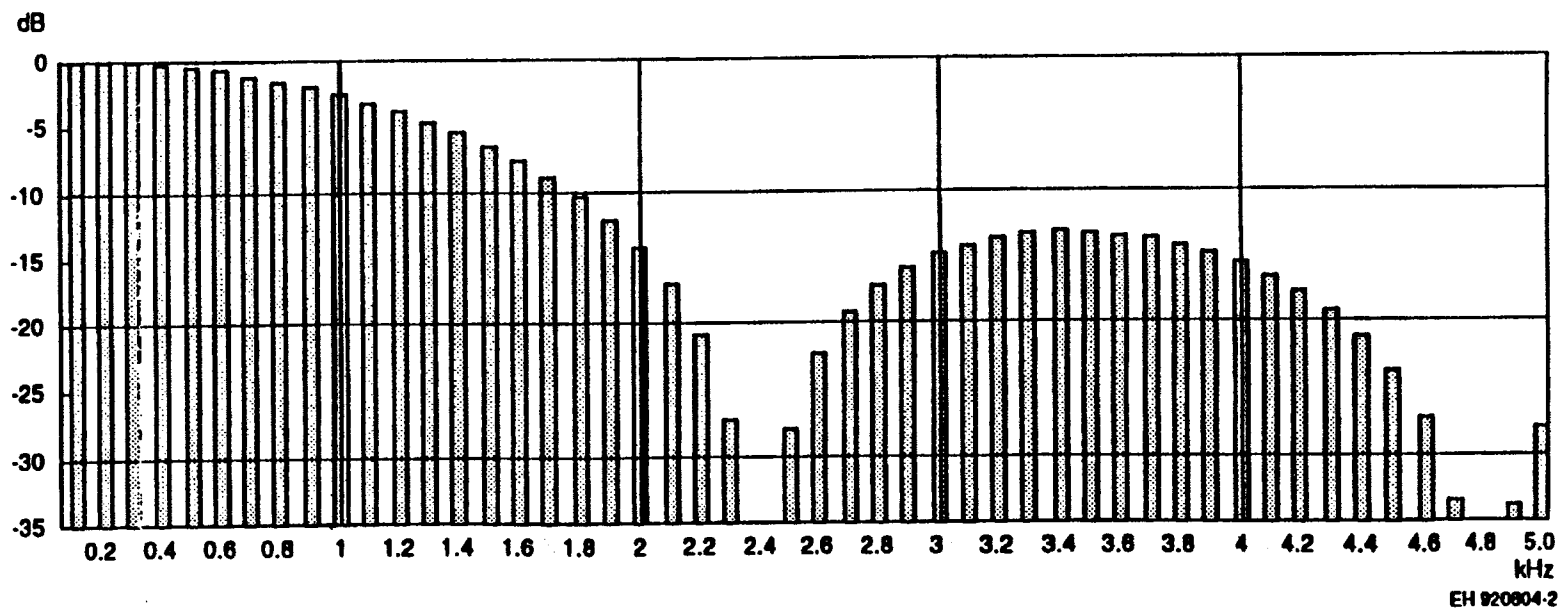

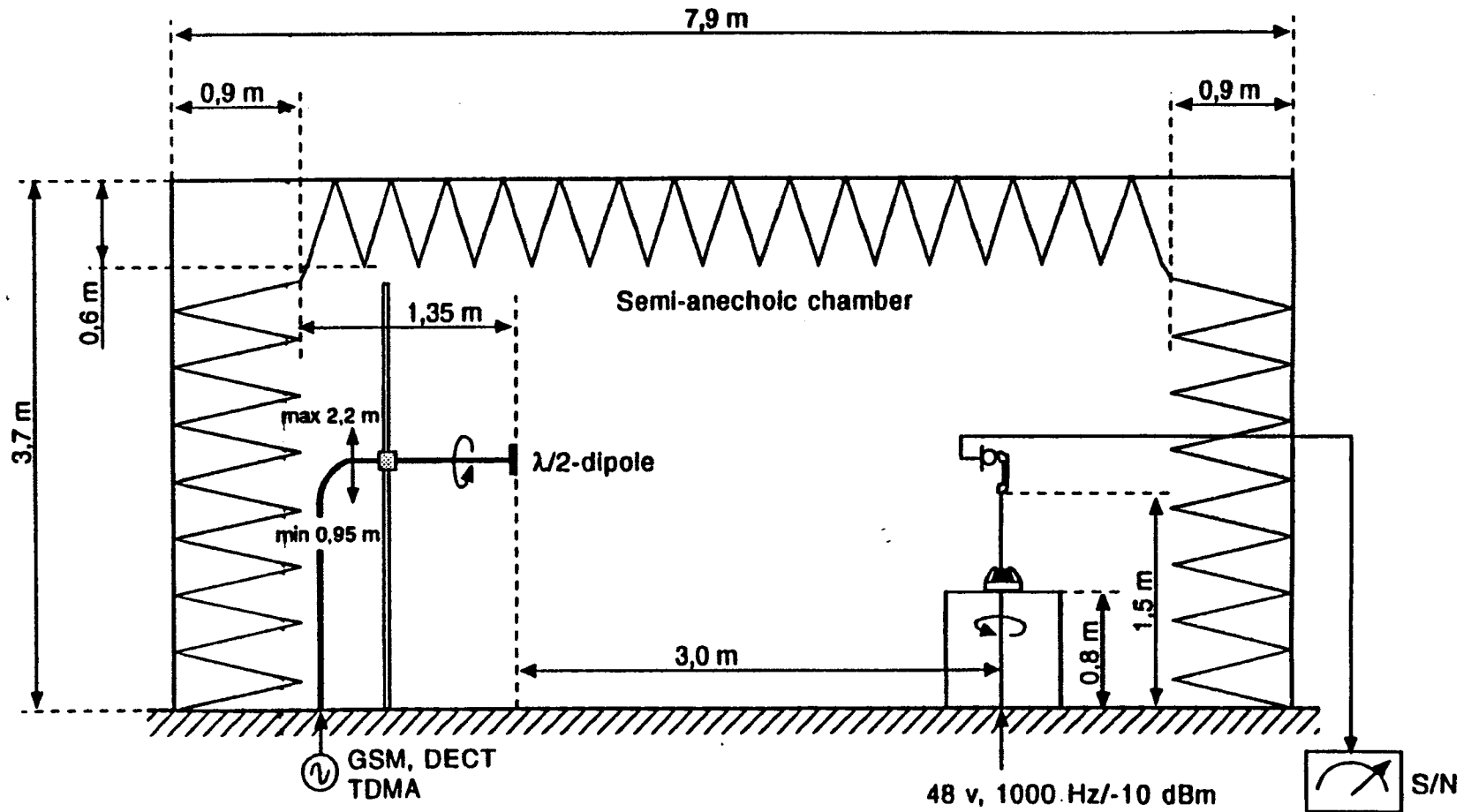

TDMA interference measuring set-up



Date 12.Jun.'92 Time 10:03:29

Ref.Lvl

-20.00 dBm

Res.Bw

49.2 Hz [3dB]

Vid.Bw

100 Hz

CF.Stp

500.000 Hz

RF.Att

10 dB

Unit

[dBm]

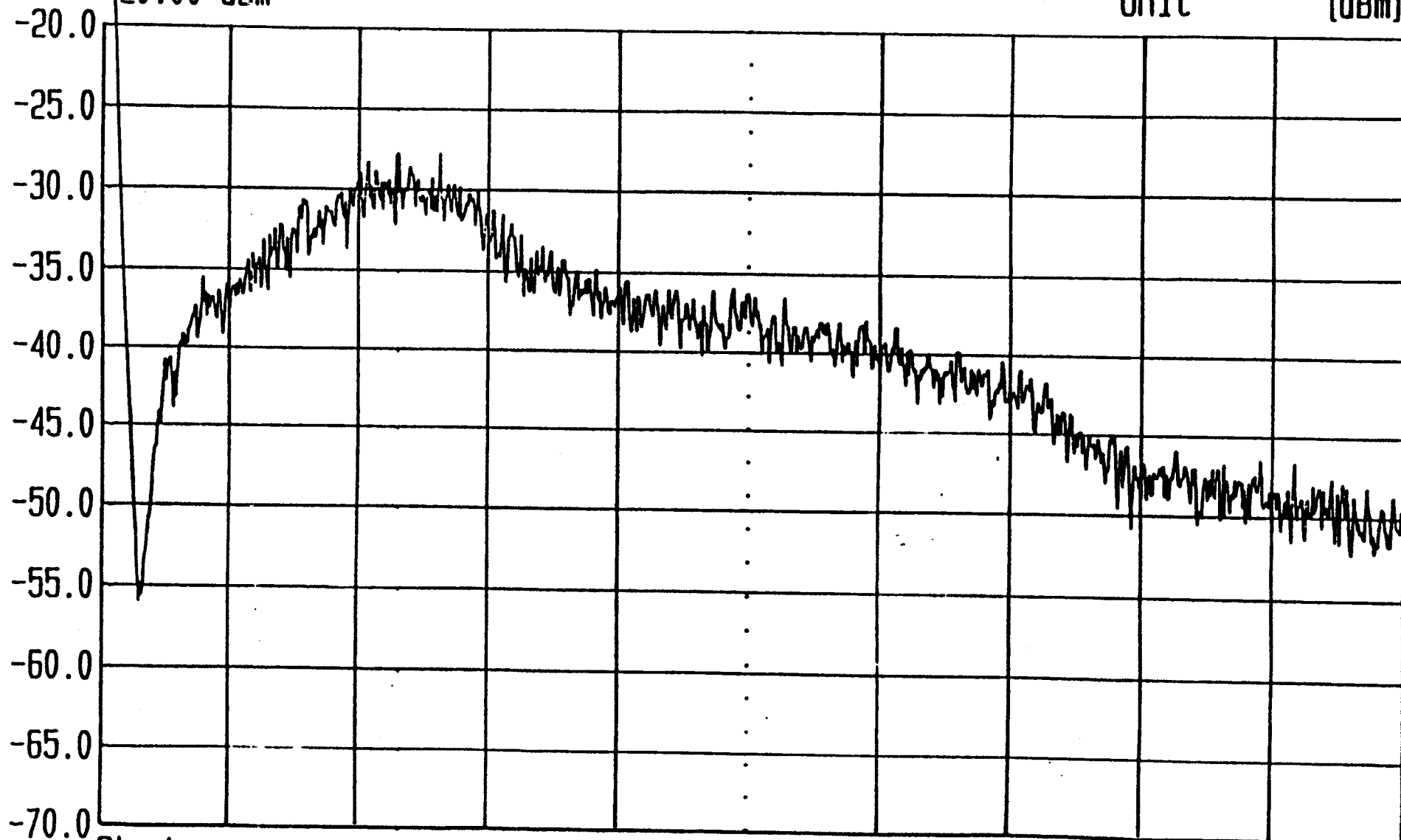

Start
0 Hz

Span
5 kHz

Center
2.5 kHz

Sweep
6.2 s

Stop
5 kHz

Frequency response telephone set nr

GSM - TDMA interference in analog PSTN telephone set Receive side Distance: 3 m

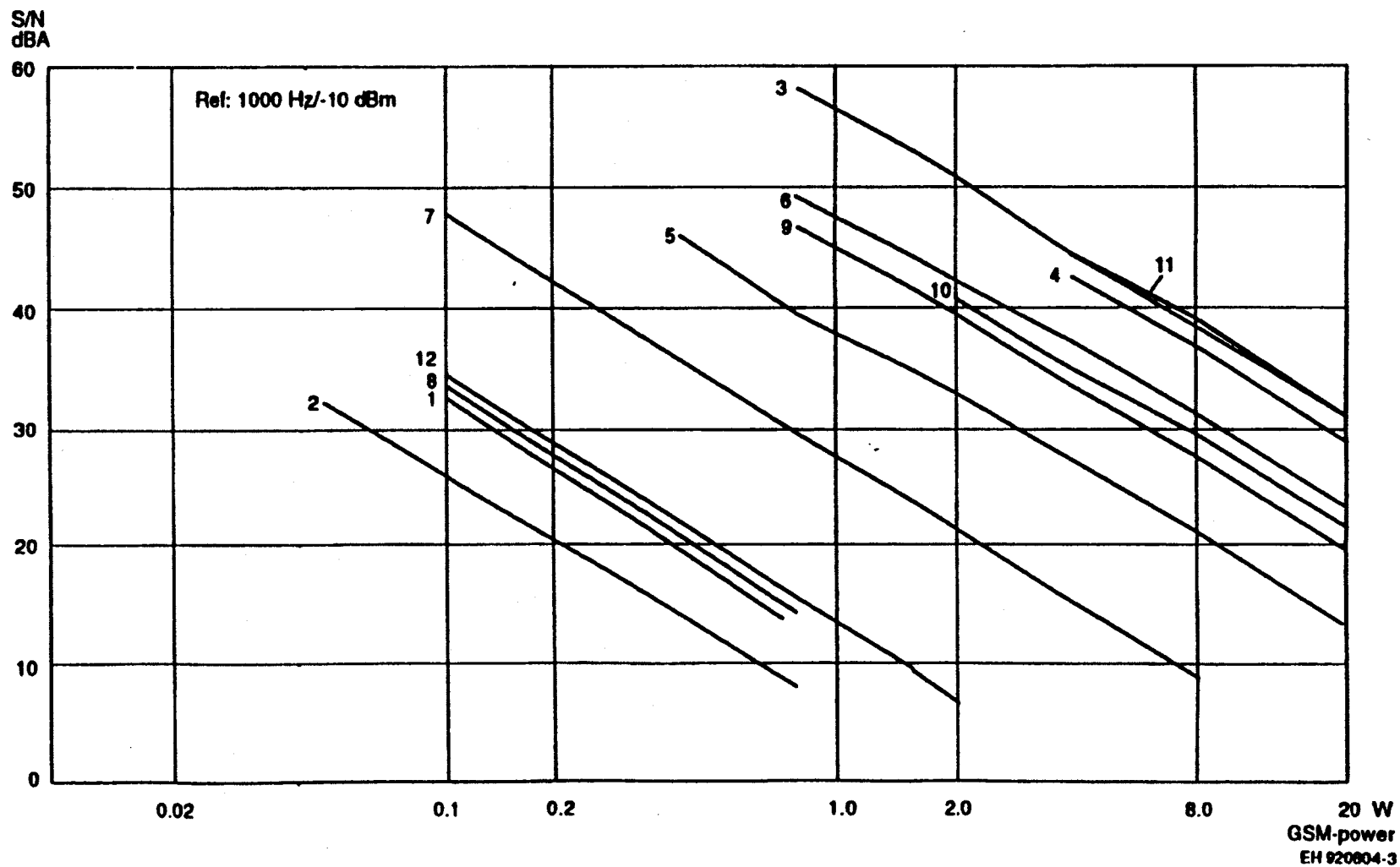

GSM - TDMA interference in analog PSTN telephone set
Transmit side
Distance: 3 m

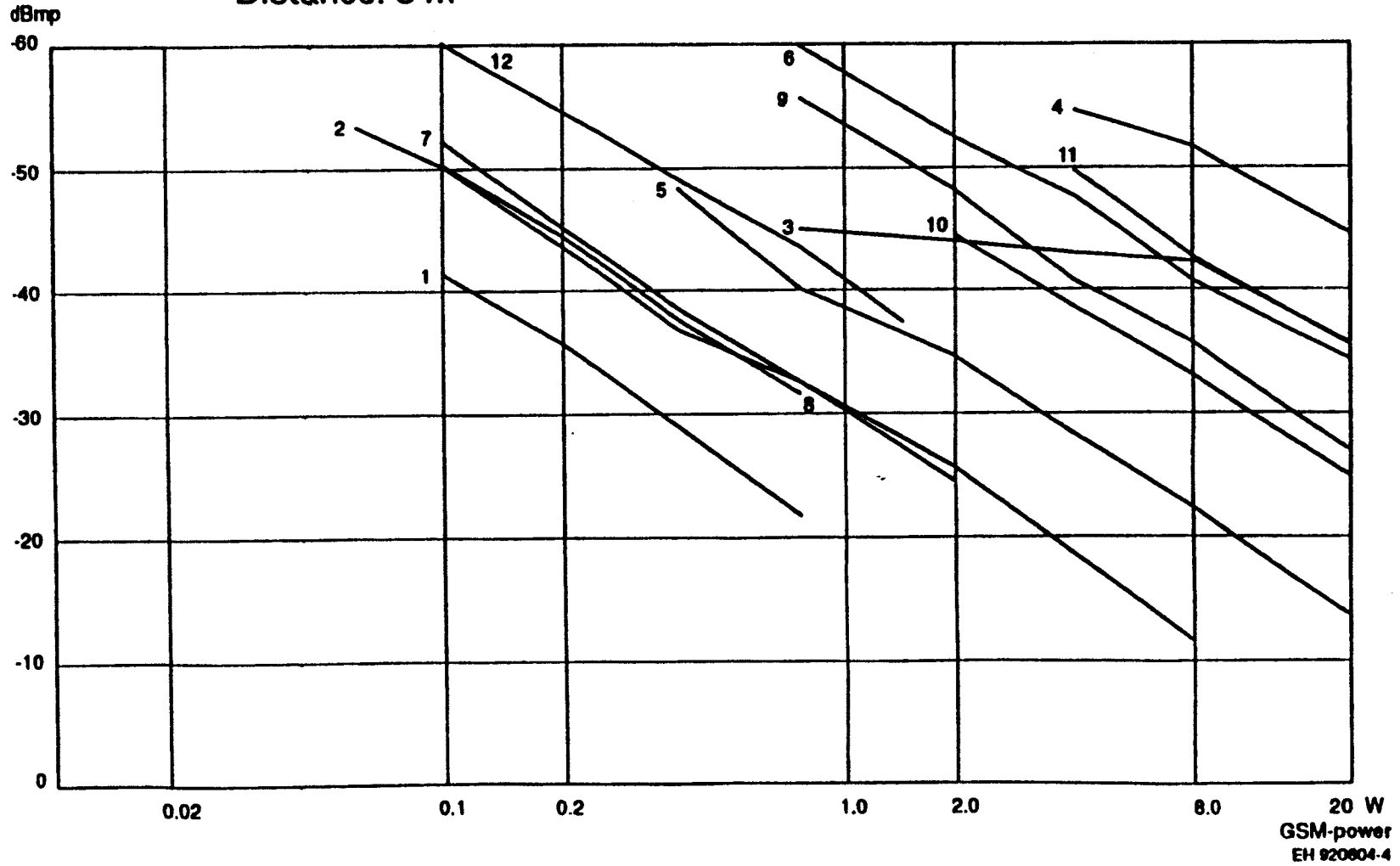



Date 12.Jun.'92 Time 12:47:59
Ref.Lvl
-10.00 dBm

Res.Bw	24.6 Hz [3dB]	Vid.Bw	30 Hz
CF.Stp	500.000 Hz	RF.Att	10 dB
		Unit	[dB]

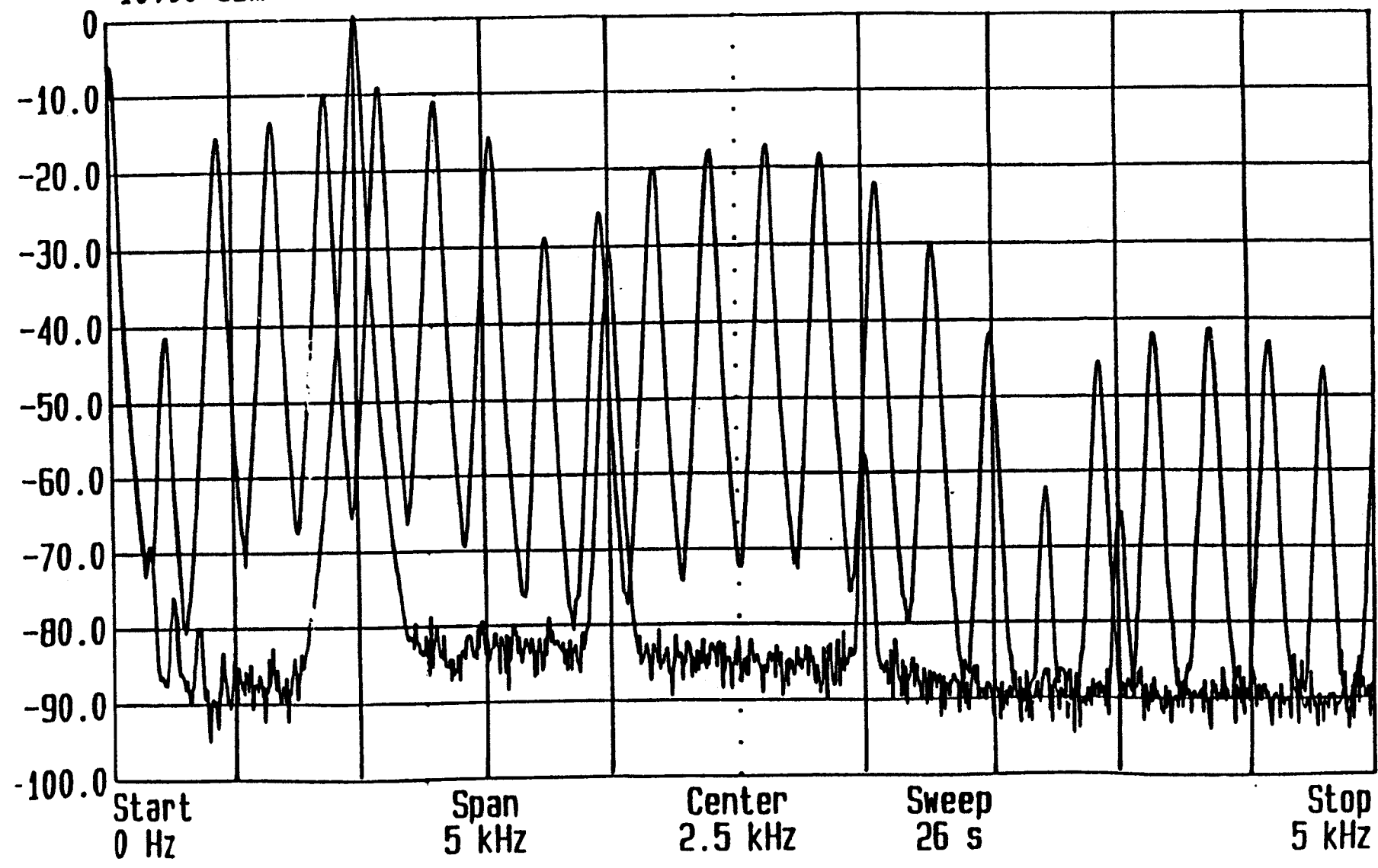

Telephone set nr 2



Date 15.Jun.'92 Time 09:44:48

Ref.Lvl

0 dBm

Res.Bw

24.6 Hz [3dB]

Vid.Bw

30 Hz

CF.Stp

500.000 Hz

RF.Att

10 dB

Unit

[dB]

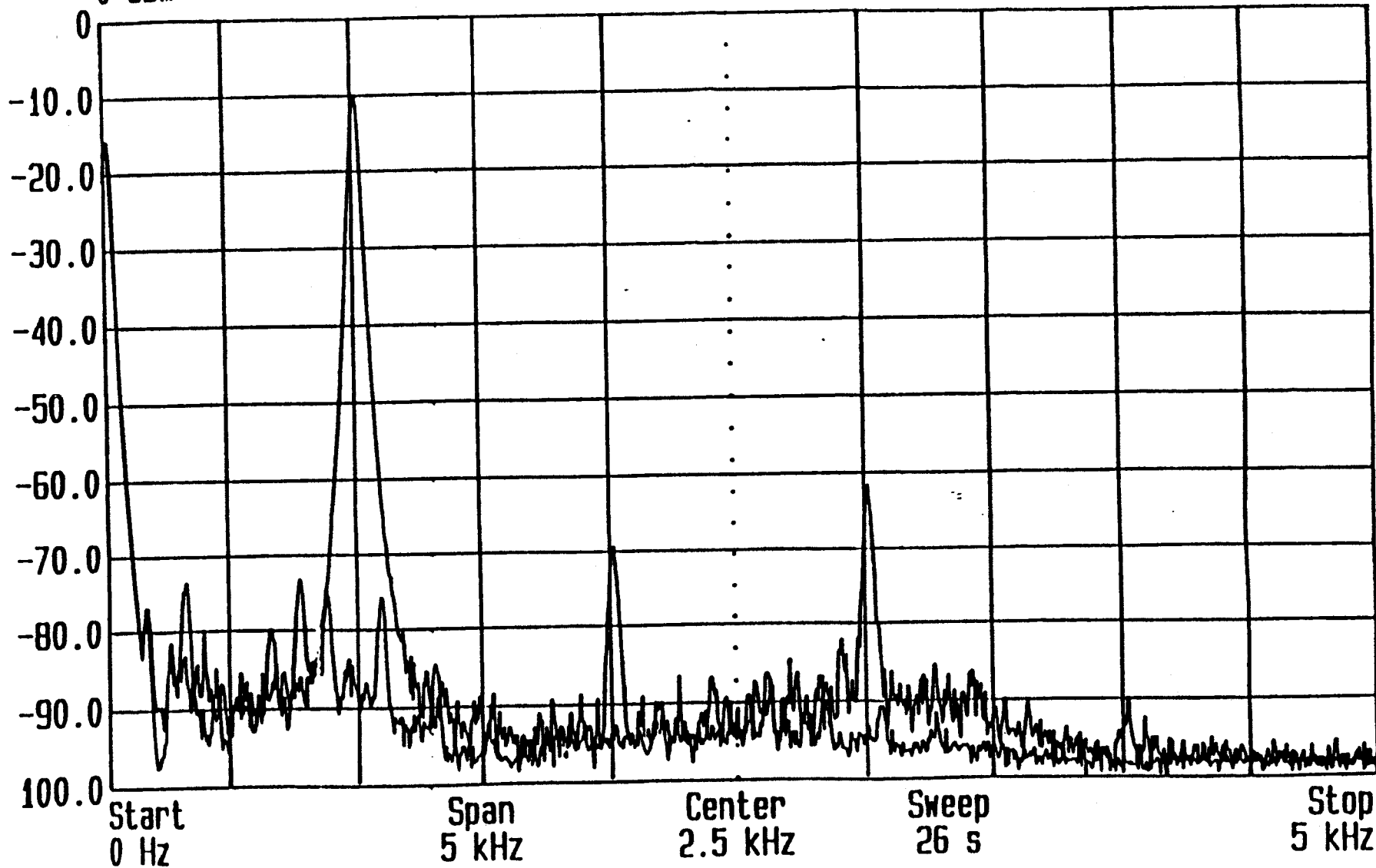

Telephone set nr 3

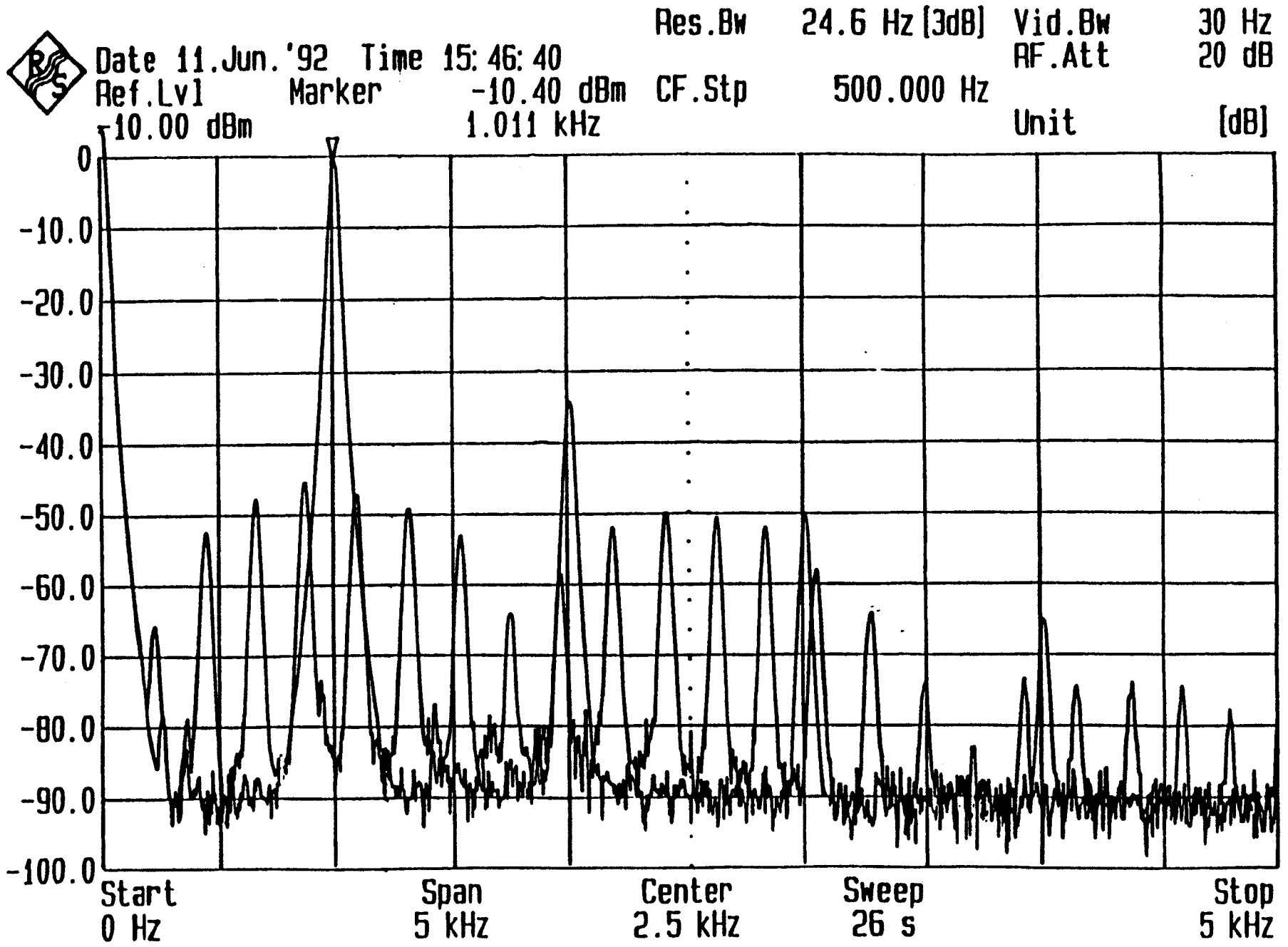

Telephone set nr 5



Date 12.Jun.'92 Time 10:24:09
Ref.Lvl
-10.00 dBm

Res.Bw	24.6 Hz [3dB]	Vid.Bw	30 Hz
CF.Stp	500.000 Hz	RF.Att	10 dB
		Unit	[dB]

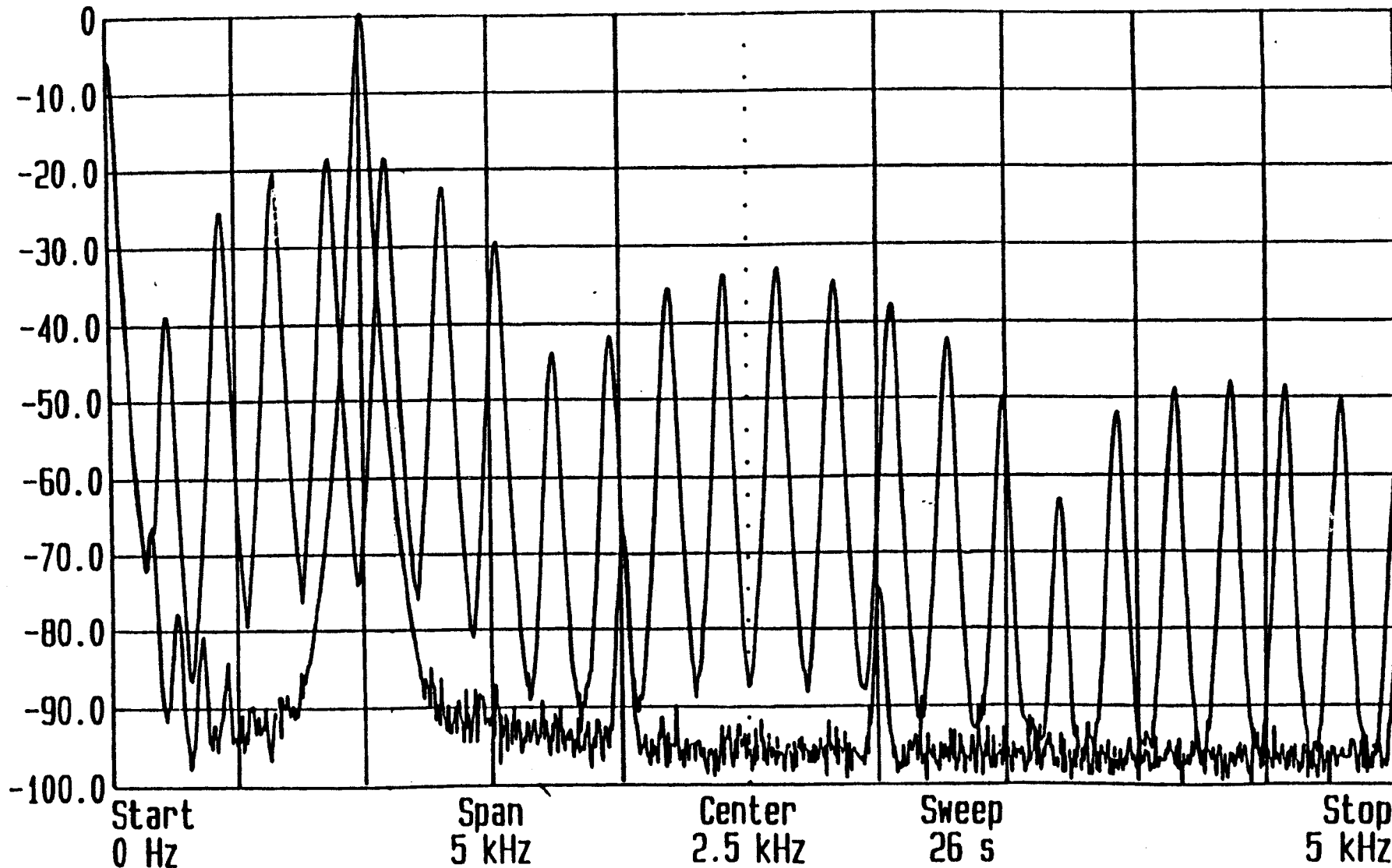

Telephone set nr 8



Date 18.Jun.'92 Time 15:09:55

Ref.Lvl Marker

-10.00 dBm

-9.90 dBm

1.011 kHz

Res.Bw

24.6 Hz [3dB]

Vid.Bw

30 Hz

RF.Att

10 dB

CF.Stp

500.000 Hz

Unit

[dB]

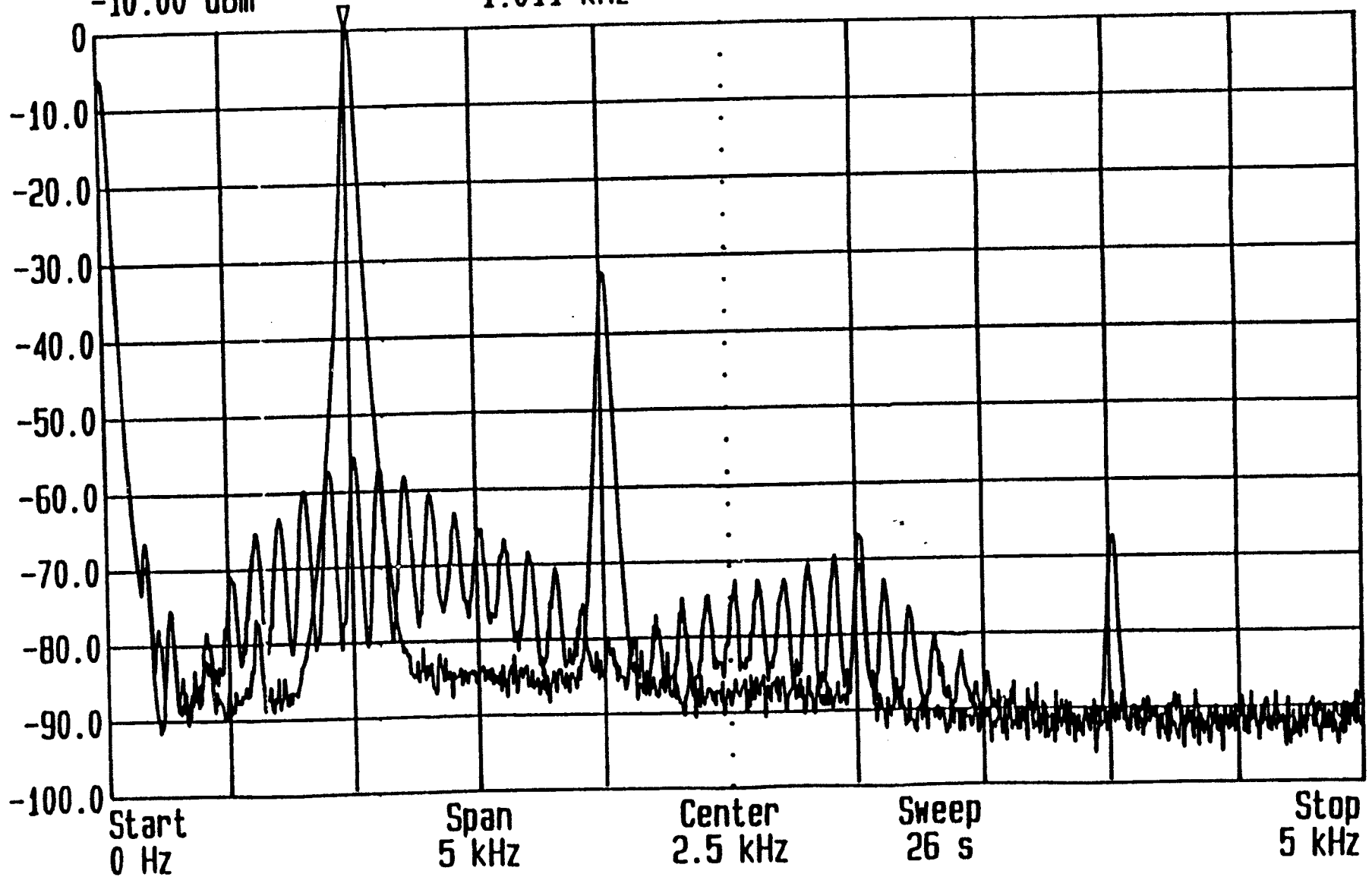

Telephone set nr 2



Date 11.Jun.'92 Time 15:46:40

Ref.Lvl Marker -10.40 dBm

10.00 dBm 1.011 kHz

Res.Bw 24.6 Hz [3dB]

Vid.Bw 30 Hz

RF.Att 20 dB

CF.Stp 500.000 Hz

Unit [dB]

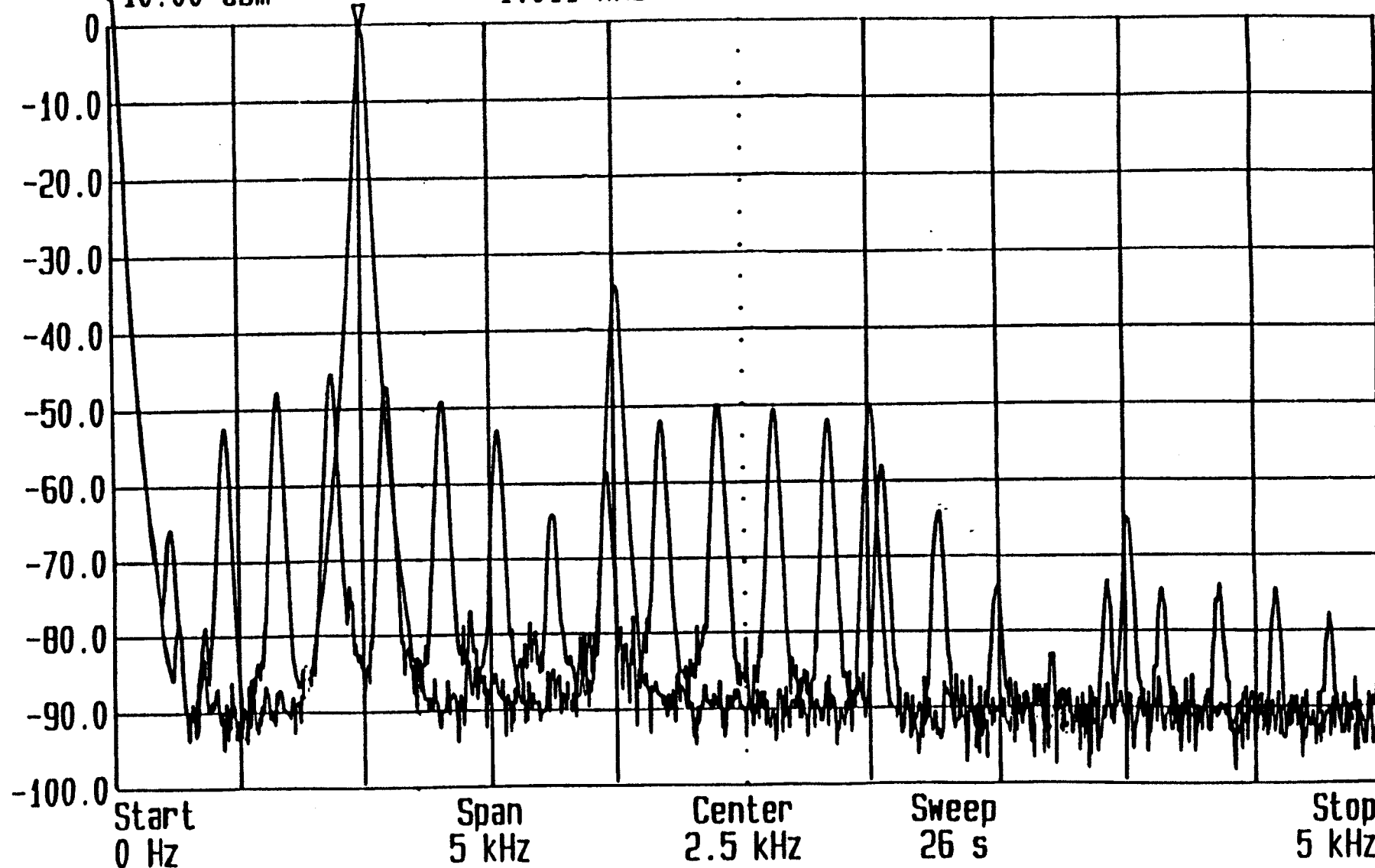

Telephone set nr 5



Date 18.Jun.'92 Time 13:55:31 Res.Bw 24.6 Hz [3dB] Vid.Bw 30 Hz
Ref.Lvl -10.00 dBm Marker -9.88 dBm CF.Stp 500.000 Hz RF.Att 10 dB
1.011 kHz Unit [dB]

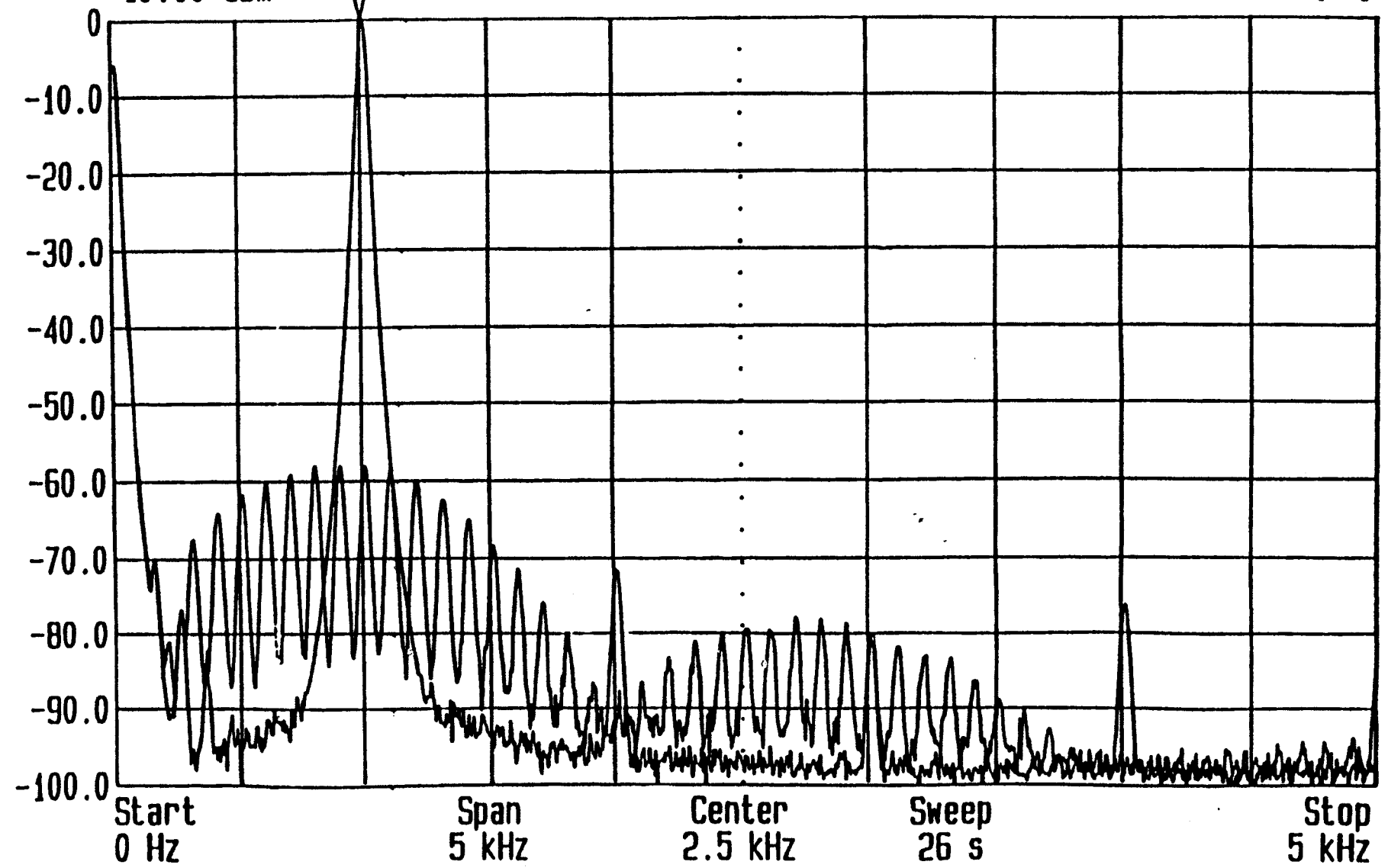

Telephone set nr 8

GSM-power 0,8 w (Handheld)

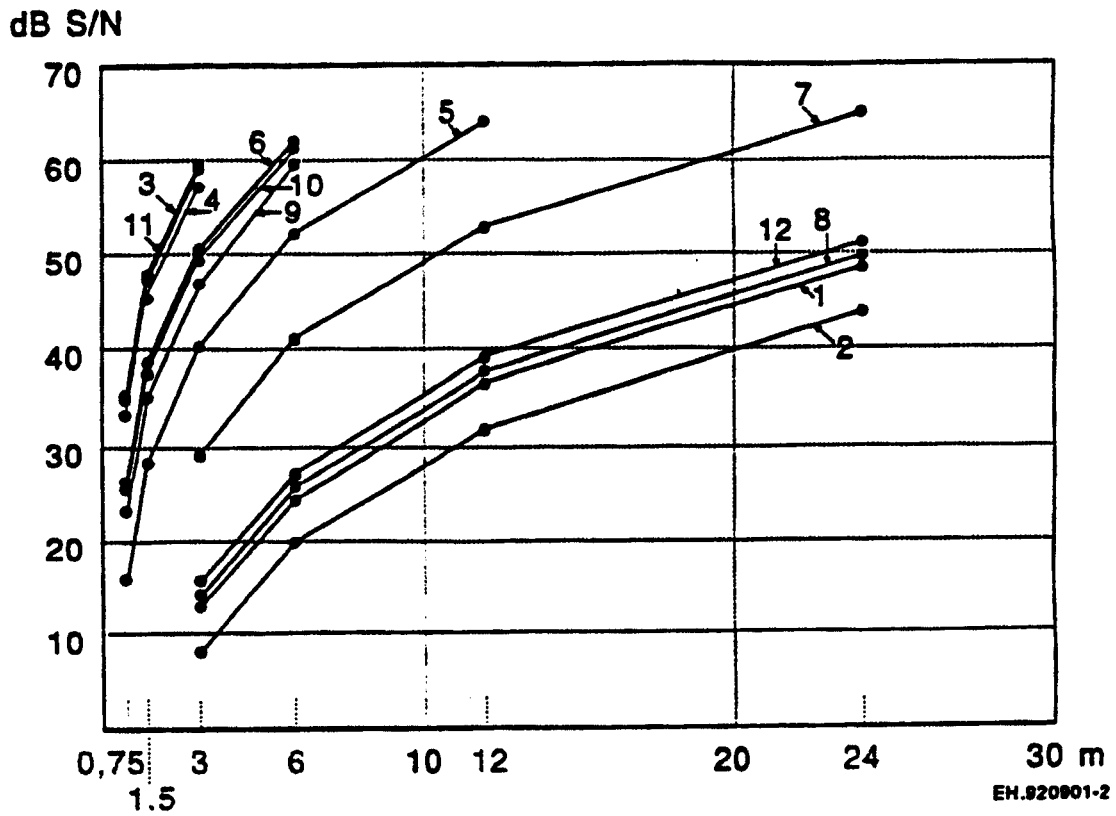

GSM-power 10 w (Car-mounted)

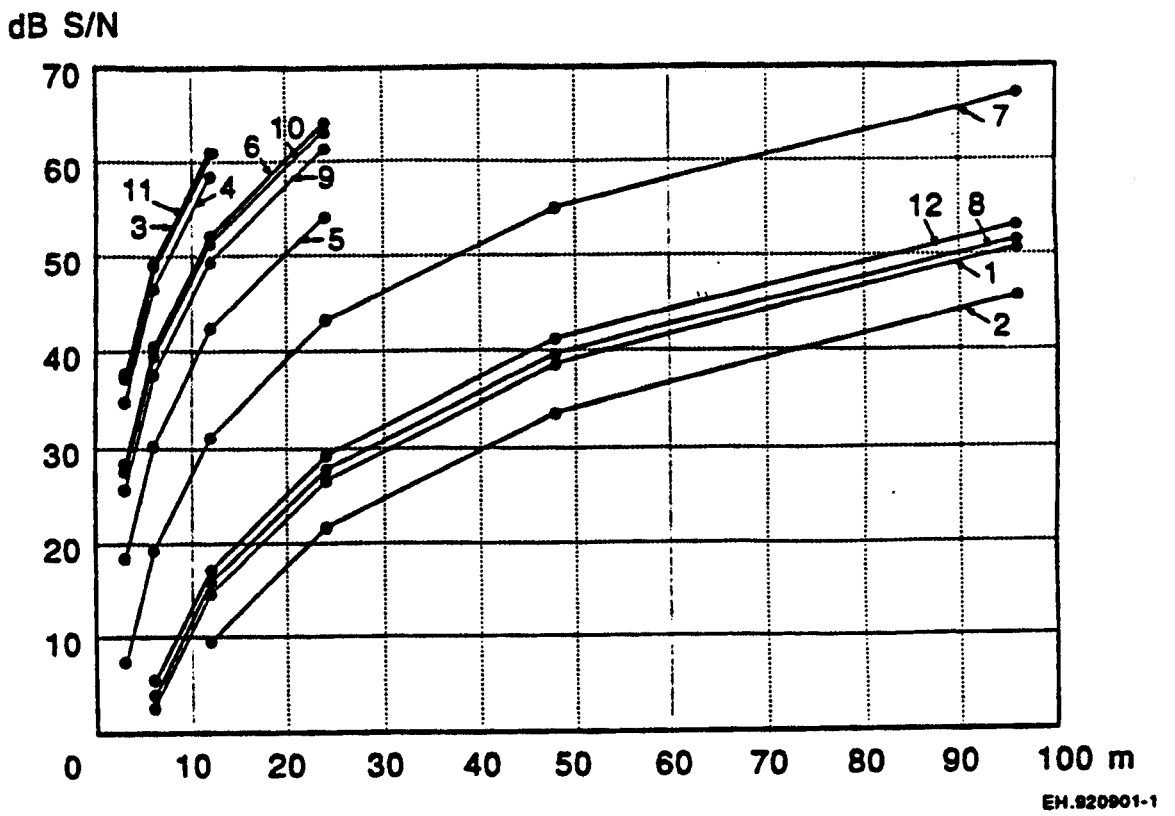

History

Document history	
January 1997	First Edition
January 1998	Upgrade to Version 6.0.0 (Release 1997).