

Source: TSG_N WG4
Title: Corrective CRs to 3G Work Item “GTP enhancements”
Agenda item: 6.14.4
Document for: APPROVAL

Introduction:

This document contains “21” Corrective CRs on Work Item “GTP enhancements”, that have been agreed by TSG_N WG4, and are forwarded to TSG_N Plenary meeting #8 for approval.

TDoc	SPEC	CR	REV	PHAS	VERS	SUBJECT	CAT	NEW_VERS
N4-000101	29.060	093	2	R99	3.4.0	Clarification on the TEID handling	F	3.5.0
N4-000026	29.060	084		R99	3.4.0	16-bit PDCP sequence numbers in GTP header	F	3.5.0
N4-000272	29.060	087	1	R99	3.4.0	Reliable delivery of signalling messages	F	3.5.0
N4-000035	29.060	089		R99	3.4.0	Condition for evaluating the sequence number fields in PDP	F	3.5.0
N4-000075	29.060	090	1	R99	3.4.0	Target RNC Information	F	3.5.0
N4-000076	29.060	091	1	R99	3.4.0	Change of the length of TI	F	3.5.0
N4-000048	29.060	096		R99	3.4.0	Restart counter in Echo Response	F	3.5.0
N4-000081	29.060	097	1	R99	3.4.0	Clarification on the use of TEID in the GTP-C header	F	3.5.0
N4-000055	29.060	098		R99	3.4.0	Add APN IE for PDU Notification Reject Request	F	3.5.0
N4-000083	29.060	099	1	R99	3.4.0	Addition of response code Delete PDP Context Response	F	3.5.0
N4-000324	29.060	100	1	R99	3.4.0	Introduction of a different port number for GTP-C and GTP-U	F	3.5.0
N4-000258	29.060	105		R99	3.4.0	Race Conditions Avoidance	F	3.5.0
N4-000259	29.060	106		R99	3.4.0	Removal of Connection oriented paths	F	3.5.0
N4-000261	29.060	108		R99	3.4.0	The use of the Sequence number in GTP-C	F	3.5.0
N4-000262	29.060	109		R99	3.4.0	the N-PDU number in GTP-C	F	3.5.0
N4-000270	29.060	112		R99	3.4.0	Introducing Supported Extension Headers Notification to	F	3.5.0
N4-000271	29.060	113		R99	3.4.0	Missing IEs in GTP-C Error Indication	F	3.5.0
N4-000279	29.060	114		R99	3.4.0	Clarification of the Cause of Create PDP Context Response	F	3.5.0
N4-000280	29.060	115		R99	3.4.0	Clarification of the TEID for Signalling	F	3.5.0
N4-000281	29.060	116		R99	3.4.0	Clarification on the TEID for Signalling of the PDU Notification	F	3.5.0
N4-000347	29.060	117	2	R99	3.4.0	Clarification of the conditional information elements	F	3.5.0

CHANGE REQUEST		Please see embedded help file at the bottom of this page for instructions on how to fill in this form correctly.	
29.060 CR 084		Current Version: 3.4.0	
GSM (AA.BB) or 3G (AA.BBB) specification number ↑		↑ CR number as allocated by MCC support team	
For submission to: CN#08 <small>list expected approval meeting # here ↑</small>	for approval <input checked="" type="checkbox"/> for information <input type="checkbox"/>	strategic <input type="checkbox"/> non-strategic <input checked="" type="checkbox"/>	(for SMG use only)

Form: CR cover sheet, version 2 for 3GPP and SMG The latest version of this form is available from: ftp://ftp.3gpp.org/Information/CR-Form-v2.doc

Proposed change affects: (U)SIM ME UTRAN / Radio Core Network
(at least one should be marked with an X)

Source: N4 **Date:** 20.03.2000

Subject: 16-bit PDCP sequence numbers in GTP header

Work item: GTP Enhancements

Category:	F Correction <input checked="" type="checkbox"/>	Release:	Phase 2 <input type="checkbox"/>
	A Corresponds to a correction in an earlier release <input type="checkbox"/>		Release 96 <input type="checkbox"/>
(only one category shall be marked with an X)	B Addition of feature <input type="checkbox"/>		Release 97 <input type="checkbox"/>
	C Functional modification of feature <input type="checkbox"/>		Release 98 <input type="checkbox"/>
	D Editorial modification <input type="checkbox"/>		Release 99 <input checked="" type="checkbox"/>
			Release 00 <input type="checkbox"/>

Reason for change: S2 decided, that PDCP sequence numbers are used (instead of RLC sequence numbers) in SRNS relocation and inter-system HO. GTP shall include PDCP number for every GTP packet, which are forwarded from source to target during handover.

In Milan CR 29.060-078r1 Added 8-bit long PDCP number to the spec. In R2 the PDCP sequence number has been decided to be 16-bit long, so this CR changes the PDCP number to 16-bits.

Clauses affected: 6, 6.1

Other specs affected:	Other 3G core specifications <input type="checkbox"/>	→ List of CRs:	
	Other GSM core specifications <input type="checkbox"/>	→ List of CRs:	
	MS test specifications <input type="checkbox"/>	→ List of CRs:	
	BSS test specifications <input type="checkbox"/>	→ List of CRs:	
	O&M specifications <input type="checkbox"/>	→ List of CRs:	

Other comments:

<----- double-click here for help and instructions on how to create a CR.

6. GTP header

... (text missing)

Optional fields:

- Sequence Number: this field is an optional field in GTP-U. It is used as a transaction identity for signalling messages in GTP-C and as an increasing sequence number for T-PDUs, transmitted via GTP-U tunnels, when transmission order must be preserved.
- N-PDU Number: this field is used at the Inter SGSN Routing Area Update procedure and some ~~SRNS relocation or~~ inter-system handover procedures (e.g. between 2G and 3G radio access networks). This field is used to co-ordinate the data transmission for acknowledged mode of communication between the MS and the SGSN or SRNC. The exact meaning of this field depends upon the scenario. (For example, for GSM/GPRS, the SMDCP N-PDU number is present in this field, while for UMTS to GSM/GPRS, the PDCP sequence number is present.)
- Next Extension Header Type: This field defines the type of Extension Header that follows this field in the G-PDU.

... (text missing)

Next Extension Header Field Value	Type of extension header
0000 0000	No more extension headers
<u>1100 0000</u>	<u>PDCP PDU number</u>

Figure 5: Definition of Extension Header types

6.1 Extension headers

6.1.1 PDCP PDU Number

This extension header is transmitted, for example, at SRNS relocation time to provide the PDCP sequence number of not yet acknowledged N-PDUs. It is 4 octets long, and therefore the Length field has value 1.

	Bits							
Octets	8	7	6	5	4	3	2	1
1	1							
2	PDCP PDU number							
3	PDCP PDU number.							
4	Next Extension Header Type (*)							

(*) The value of this field is 0 if no other Extension header follows.

Figure 6: PDCP PDU number Extension Header

CHANGE REQUEST		Please see embedded help file at the bottom of this page for instructions on how to fill in this form correctly.	
29.060	CR	087r1	Current Version: 3.4.0
GSM (AA.BB) or 3G (AA.BBB) specification number ↑		↑ CR number as allocated by MCC support team	
For submission to: CN#08 <small>list expected approval meeting # here ↑</small>	for approval <input checked="" type="checkbox"/>	strategic <input type="checkbox"/>	(for SMG use only)
	for information <input type="checkbox"/>	non-strategic <input checked="" type="checkbox"/>	

Form: CR cover sheet, version 2 for 3GPP and SMG The latest version of this form is available from: <ftp://ftp.3gpp.org/Information/CR-Form-v2.doc>

Proposed change affects: (U)SIM ME UTRAN / Radio Core Network
(at least one should be marked with an X)

Source: N4 **Date:** May 12th 2000

Subject: Reliable delivery of signalling messages

Work item: GTP Enhancements

Category:	F Correction <input checked="" type="checkbox"/> A Corresponds to a correction in an earlier release <input type="checkbox"/> B Addition of feature <input type="checkbox"/> C Functional modification of feature <input type="checkbox"/> D Editorial modification <input type="checkbox"/>	Release:	Phase 2 <input type="checkbox"/> Release 96 <input type="checkbox"/> Release 97 <input type="checkbox"/> Release 98 <input type="checkbox"/> Release 99 <input checked="" type="checkbox"/> Release 00 <input type="checkbox"/>
------------------	--	-----------------	--

(only one category shall be marked with an X)

Reason for change: To be able to use the procedure for reliable delivery of signalling messages as defined in section 7.6, for the messages "Forward Relocation Complete" and "Forward SRNS Context" two new messages must be added: Forward Relocation Complete Acknowledge" and "Forward SRNS Context Acknowledge". The Forward SRNS Context message over the Gn interface corresponds to the Relocation Commit message on the lur interface. The Forward Relocation Complete message is triggered by a Relocation Complete message over the lu interface. Note that both the lur and the lu interface have reliable delivery of messages.

Clauses affected: _____

Other specs affected:	Other 3G core specifications <input checked="" type="checkbox"/> Other GSM core specifications <input type="checkbox"/> MS test specifications <input type="checkbox"/> BSS test specifications <input type="checkbox"/> O&M specifications <input type="checkbox"/>	→ List of CRs: 23.060 CR 152 → List of CRs: → List of CRs: → List of CRs: → List of CRs:
------------------------------	--	---

Other comments: See also the corresponding 23.060 CR 152 submitted to SA2#13, Berlin 22-26 May.

7.1 Signalling Message Formats

GTP defines a set of signalling messages between two associated GSNs or an SGSN and an RNC. The signalling messages to be used are defined in the table below. The three columns to the right define which parts (GTP-C, GTP-U or GTP') that send or receive the specific message type.

Table 1: Signalling messages in GTP

Message Type value (Decimal)	Signalling message	Reference	GTP-C	GTP-U	GTP'
0	For future use. Shall not be sent. If received, shall be treated as an Unknown message.				
1	Echo Request	7.2.1	X	X	
2	Echo Response	7.2.2	X	X	
3	Version Not Supported	7.2.3	X	X	
4	Node Alive Request	GSM 12.15			X
5	Node Alive Response	GSM 12.15			X
6	Redirection Request	GSM 12.15			X
7	Redirection Response	GSM 12.15			X
8-15	For future use. Shall not be sent. If received, shall be treated as an Unknown message.				
16	Create PDP Context Request	7.3.1	X		
17	Create PDP Context Response	7.3.2	X		
18	Update PDP Context Request	7.3.3	X		
19	Update PDP Context Response	7.3.4	X		
20	Delete PDP Context Request	7.3.5	X		
21	Delete PDP Context Response	7.3.6	X		
22-25	For future use. Shall not be sent. If received, shall be treated as an Unknown message.				
26	Error Indication	7.3.7	X		
27	PDU Notification Request	7.3.8	X		
28	PDU Notification Response	7.3.9	X		
29	PDU Notification Reject Request	7.3.10	X		
30	PDU Notification Reject Response	7.3.11	X		
31	Supported Extension Headers Notification	7.3.12	X		
32	Send Routing Information for GPRS Request	7.4.1	X		
33	Send Routing Information for GPRS Response	7.4.2	X		
34	Failure Report Request	7.4.3	X		
35	Failure Report Response	7.4.4	X		
36	Note MS GPRS Present Request	7.4.5	X		
37	Note MS GPRS Present Response	7.4.6	X		
38-47	For future use. Shall not be sent. If received, shall be treated as an Unknown message.				
48	Identification Request	7.5.1	X		
49	Identification Response	7.5.2	X		
50	SGSN Context Request	7.5.3	X		
51	SGSN Context Response	7.5.4	X		
52	SGSN Context Acknowledge	7.5.5	X		
53	Forward Relocation Request	7.5.6	X		
54	Forward Relocation Response	7.5.7	X		
55	Forward Relocation Complete	7.5.8	X		
56	Relocation Cancel Request	7.5.9	X		
57	Relocation Cancel Response	7.5.10	X		
58	Forward SRNS Context	7.5.11	X		
xx	Forward Relocation Complete Acknowledge	7.5.x	X		
xx	Forward SRNS Context Acknowledge	7.5.x	X		
59xx-239	For future use. Shall not be sent. If received, shall be treated as an Unknown message.				
240	Data Record Transfer Request	GSM 12.15			X
241	Data Record Transfer Response	GSM 12.15			X
242-254	For future use. Shall not be sent. If received, shall be treated as an Unknown message.				
255	T-PDU	9.3.1		X	

7.5.x Forward Relocation Complete Acknowledge

The old SGSN sends a Forward Relocation Complete Acknowledge message to the new SGSN as a response to Forward Relocation Complete.

Possible Cause Values are:

- 'Request Accepted'
- 'Optional IE incorrect'
- 'Invalid message format'
- 'Version not supported'

The optional Private Extension contains vendor or operator specific information.

Table XX: Information elements in a Forward Relocation Complete Acknowledge

Information element	Presence requirement	Reference
Cause	Mandatory	7.7.1
Private Extension	Optional	7.7.26

7.5.x Forward SRNS Context Acknowledge

The new SGSN sends a Forward SRNS Context Acknowledge message to the old SGSN as a response to Forward SRNS Context.

Possible Cause values are:

- 'Request Accepted'
- 'Mandatory IE incorrect'
- 'Mandatory IE missing'
- 'Optional IE incorrect'
- 'Invalid message format'
- 'Version not supported'

Table XX: Information elements in a Forward SRNS Context Acknowledge

<u>Information element</u>	<u>Presence requirement</u>	<u>Reference</u>
<u>Cause</u>	<u>Mandatory</u>	<u>7.7.1</u>
<u>Private Extension</u>	<u>Optional</u>	<u>7.7.26</u>

7.6 Reliable delivery of signalling messages

Each path maintains a queue with signalling messages to be sent to the peer. The message at the front of the queue shall be sent with a Sequence Number, and shall be held in a path list until a response is received. Each path has its own list. The Sequence Number shall be unique for each outstanding message in a single path list. A GSN may have several outstanding requests while waiting for responses.

The T3-RESPONSE timer shall be started when a signalling request message is sent. A signalling message request or response has probably been lost if a response has not been received before the T3-RESPONSE timer expires. The request is then retransmitted if the total number of request attempts is less than N3-REQUESTS times. The timer shall be implemented in the signalling application. The wait time for a response (T3-RESPONSE timer value) and the number of retries (N3-REQUESTS) shall be configurable per procedure. The total wait time shall be shorter than the MS wait time between retries of Attach and RA Update messages.

All received request messages shall be responded to and all response messages associated with a certain request shall always include the same information. Duplicated response messages shall be discarded. A response message without a matching outstanding request should be considered as a duplicate.

The Forward Relocation Complete and Forward SRNS Context messages shall be treated as signalling request messages. The Forward Relocation Complete Acknowledge and Forward SRNS Context Acknowledge messages shall be treated as response messages.

If a GSN is not successful with the transfer of a signalling message, e.g. a Create PDP Context Request message, it shall inform the upper layer of the unsuccessful transfer so that the controlling upper entity may take the necessary measures.

<h2 style="margin: 0;">CHANGE REQUEST</h2>		Please see embedded help file at the bottom of this page for instructions on how to fill in this form correctly.
29.060	CR 089	Current Version: 3.4.0
GSM (AA.BB) or 3G (AA.BBB) specification number ↑	↑ CR number as allocated by MCC support team	
For submission to: CN#08 <small>list expected approval meeting # here ↑</small>	for approval <input checked="" type="checkbox"/> for information <input type="checkbox"/>	strategic <input type="checkbox"/> non-strategic <input checked="" type="checkbox"/> <small>(for SMG use only)</small>

Form: CR cover sheet, version 2 for 3GPP and SMG The latest version of this form is available from: <ftp://ftp.3gpp.org/Information/CR-Form-v2.doc>

Proposed change affects: (U)SIM ME UTRAN / Radio Core Network
(at least one should be marked with an X)

Source: N4 **Date:** 2000-03-16

Subject: Condition for evaluating the sequence number fields in PDP context

Work item: GTP enhancements

Category:	F Correction <input checked="" type="checkbox"/> A Corresponds to a correction in an earlier release <input type="checkbox"/> B Addition of feature <input type="checkbox"/> C Functional modification of feature <input type="checkbox"/> D Editorial modification <input type="checkbox"/>	Release:	Phase 2 <input type="checkbox"/> Release 96 <input type="checkbox"/> Release 97 <input type="checkbox"/> Release 98 <input type="checkbox"/> Release 99 <input checked="" type="checkbox"/> Release 00 <input type="checkbox"/>
------------------	--	-----------------	--

(only one category shall be marked with an X)

Reason for change: During UMTS handover/relocation the sequence number status for GTP-U and PDCP are transferred between the involved RNCs either via Iur in the RNSAP message Relocation Commit or via CN in the GTP message Forward SRNS Context. Consequently, the SND, SNU and N-PDU number fields in the PDP contexts transferred by GTP shall not be evaluated by the new SGSN during UMTS handover/relocation.

Clauses affected:

Other specs affected:	Other 3G core specifications <input type="checkbox"/> Other GSM core specifications <input type="checkbox"/> MS test specifications <input type="checkbox"/> BSS test specifications <input type="checkbox"/> O&M specifications <input type="checkbox"/>	→ List of CRs: → List of CRs: → List of CRs: → List of CRs: → List of CRs:
------------------------------	---	--

Other comments:

7.7.19 PDP Context

The PDP Context information element contains the Session Management parameters, defined for an external packet data network address, that are necessary to transfer between SGSNs at the Inter SGSN Routing Area Update procedure.

NSAPI is an integer value in the range [0; 15].

The NSAPI points out the affected PDP context.

The SAPI indicates the LLC SAPI which is associated with the NSAPI.

Transaction Identifier is the 4 bit Transaction Identifier used in the GSM 04.08 Session Management messages which control this PDP Context.

Reordering Required (Order) indicates whether the SGSN shall reorder T-PDUs before delivering the T-PDUs to the MS.

VPLMN Address Allowed (VAA) indicates whether the MS is allowed to use the APN in the domain of the HPLMN only, or additionally the APN in the domain of the VPLMN.

QoS Sub Length, QoS Req Length and QoS Neg Length represent respectively the lengths of the QoS Sub, QoS Req and QoS Neg fields, excluding the QoS Length octet.

Quality of Service Subscribed (QoS Sub), Quality of Service Requested (QoS Req) and Quality of Service Negotiated (QoS Neg) are encoded as described in section 'Quality of Service (QoS) Profile'.

The Sequence Number Down is the number of the next T-PDU that shall be sent from the new SGSN to the MS. The number is associated to the Sequence Number from the GTP Header of an encapsulated T-PDU.

The Sequence Number Up is the number that new SGSN shall use as the Sequence Number in the GTP Header for the next encapsulated T-PDU from the MS to the GGSN.

The Send N-PDU Number is used only when acknowledged peer-to-peer LLC operation is used for the PDP context. The Send N-PDU Number is the N-PDU number to be assigned by SNDSCP to the next downlink N-PDU received from the GGSN. It shall be set to 255 if unacknowledged peer-to-peer LLC operation is used for the PDP context.

The Receive N-PDU Number is used only when acknowledged peer-to-peer LLC operation is used for the PDP context. The Receive N-PDU Number is the N-PDU number expected by SNDSCP from the next uplink N-PDU to be received from the MS. It shall be set to 255 if unacknowledged peer-to-peer LLC operation is used for the PDP context.

The Uplink Tunnel Endpoint Identifier Signalling is the Tunnel Endpoint Identifier used between the old SGSN and the GGSN in uplink direction for signalling purpose. It shall be used by the new SGSN within the GTP header of the Update PDP Context Request message.

The PDP Type Organization and PDP Type Number are encoded as in the End User Address information element.

The PDP Address Length represents the length of the PDP Address field, excluding the PDP Address Length octet.

The PDP Address is an octet array with a format dependent on the PDP Type. The PDP Address is encoded as in the End User Address information element if the PDP Type is IPv4, IPv6 or X.25.

The GGSN Address Length represents the length of the GGSN Address field, excluding the GGSN Address Length octet.

The old SGSN includes the GGSN Address for signalling that it has received from GGSN at PDP context activation or update.

The APN is the APN in use in the old SGSN. I.e. the APN sent in the Create PDP Context request message.

The spare bits x indicate unused bits which shall be set to 0 by the sending side and which shall not be evaluated by the receiving side.

1	Type = 130 (Decimal)				
2-3	Length				
4	Res- rved	AA	Res- rved	rder	NSAPI
5	X	X	X	X	SAPI
6	QoS Sub Length				
7 - (q+6)	QoS Sub [3..15]				
q+7	QoS Req Length				
(q+8)- (2q+7)	QoS Req [3..15]				
2q+8	QoS Neg. Length				
(2q+9)- (3q+8)	QoS Neg [3..15]				
(3q+9)- (3q+10)	Sequence Number Down (SND) ¹⁾				
(3q+11)- (3q+12)	Sequence Number Up (SNU) ¹⁾				
3q+13	Send N-PDU Number ¹⁾				
3q+14	Receive N-PDU Number ¹⁾				
(3q+15)- (3q+18)	Uplink Tunnel Endpoint Identifier Signalling				
3q+19	Spare 1 1 1 1			PDP Type Organization	
3q+20	PDP Type Number				
3q+21	PDP Address Length				
(3q+22)-m	PDP Address [1..63]				
m+1	GGSN Address for signalling Length				
(m+2)-n	GGSN Address for signalling [4..16]				
n+1	APN length				
(n+2)-o	APN				
o+1	Spare (sent as 0 0 0 0)			Transaction Identifier	

Figure 33: PDP Context information element

¹⁾ This field shall not be evaluated when the PDP context is received during UMTS intra system handover/relocation.

Table 46: Reordering Required values

Reordering Required	Value (Decimal)
No	0
Yes	1

Table 47: VPLMN Address Allowed values

VPLMN Address Allowed	Value (Decimal)
No	0
Yes	1

<h2 style="margin: 0;">CHANGE REQUEST</h2>		Please see embedded help file at the bottom of this page for instructions on how to fill in this form correctly.
29.060	CR 090r1	Current Version: 3.3.0
GSM (AA.BB) or 3G (AA.BBB) specification number ↑	↑ CR number as allocated by MCC support team	
For submission to: CN#08 <small>list expected approval meeting # here ↑</small>	for approval <input checked="" type="checkbox"/> For information <input type="checkbox"/>	strategic <input type="checkbox"/> non-strategic <input checked="" type="checkbox"/> <small>(for SMG use only)</small>

Form: CR cover sheet, version 2 for 3GPP and SMG The latest version of this form is available from: <ftp://ftp.3gpp.org/Information/CR-Form-v2.doc>

Proposed change affects: (U)SIM ME UTRAN / Radio Core Network
(at least one should be marked with an X)

Source: N4 **Date:** 2000-03-27

Subject: Target RNC Information

Work item: GTP Enhancements

Category:	F Correction <input checked="" type="checkbox"/> A Corresponds to a correction in an earlier release <input type="checkbox"/> B Addition of feature <input type="checkbox"/> C Functional modification of feature <input type="checkbox"/> D Editorial modification <input type="checkbox"/>	Release:	Phase 2 <input type="checkbox"/> Release 96 <input type="checkbox"/> Release 97 <input type="checkbox"/> Release 98 <input type="checkbox"/> Release 99 <input checked="" type="checkbox"/> Release 00 <input type="checkbox"/>
------------------	--	-----------------	--

(only one category shall be marked with an X)

Reason for change: During relocation the target RNC informs the new SGSN of the RABs setup but also the RABs that failed to setup. Currently the information about which RABs that failed to setup is not transferred in the Forward Relocation Response message. Furthermore, the new SGSN may decide that some of the RABs shall not be relocated and this should be communicated to the source RNC. The proposed changes are to include information about which RABs that shall be released and to rename the Target Information IE to 'RAB Setup Information'.

Clauses affected: _____

Other specs affected:	Other 3G core specifications <input type="checkbox"/> Other GSM core specifications <input type="checkbox"/> MS test specifications <input type="checkbox"/> BSS test specifications <input type="checkbox"/> O&M specifications <input type="checkbox"/>	→ List of CRs: → List of CRs: → List of CRs: → List of CRs: → List of CRs:	
------------------------------	---	--	--

Other comments: _____

7.5.7 Forward Relocation Response

The new SGSN shall send a Forward Relocation Response to the old SGSN as a response to a previous Forward Relocation Request.

Possible Cause values is:

- 'Request Accepted'
- 'System failure'
- 'Mandatory IE incorrect'
- 'Mandatory IE missing'
- 'Optional IE incorrect'
- 'No resources available'
- 'Invalid message format'
- 'Version not supported'.

The Cause and RANAP Cause information element shall be included in the response if the Cause contains another value than 'Request accepted'.

All information elements are mandatory, except Private Extension, if the Cause contains the value 'Request accepted'.

RANAP Cause is mandatory if cause value contains in RANAP message.

Transparent container and RANAP Cause are informed from the target RNC in the new SGSN.

~~Single number or plural number of~~ One or more Target RNC RAB Setup Information parameter(s) shall be set in this message.

The optional Private Extension contains vendor or operator specific information.

Table 33: Information elements in a Forward Relocation Response

Information element	Presence requirement	Reference
Cause	Mandatory	7.7.1
Private Extension	Optional	7.7.26
UTRAN transparent container	Optional	7.7.32
RANAP Cause	Conditional	7.7.33
<u>Target RNC RAB Setup</u> Information	Conditional	7.7.34

7.7.34 Target RNC RAB Setup Information

If the target RNC successfully allocated resources associated with the NSAPI, the Target RNC RAB Setup Information information element contains the RNC Tunnel Endpoint Identifier and RNC IP address for data transmission forwarding from source RNC to target RNC. If the target RNC or the new SGSN failed to allocate resources the RAB Setup Information IE contains only Length and NSAPI indicating that the source RNC shall release the resources associated with the NSAPI.

The spare bits x indicate unused bits, which shall be set to 0 by the sending side and which shall not be evaluated by the receiving side.

The format of the RNC IP address is the same as the GSN address as defined in TS 23.003.

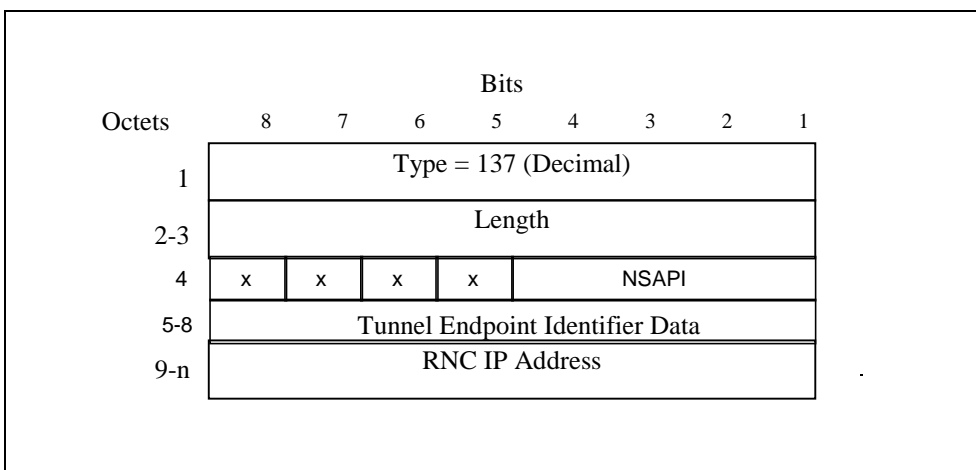

Figure 48: Target RNC RAB Setup Information information element for data forwarding

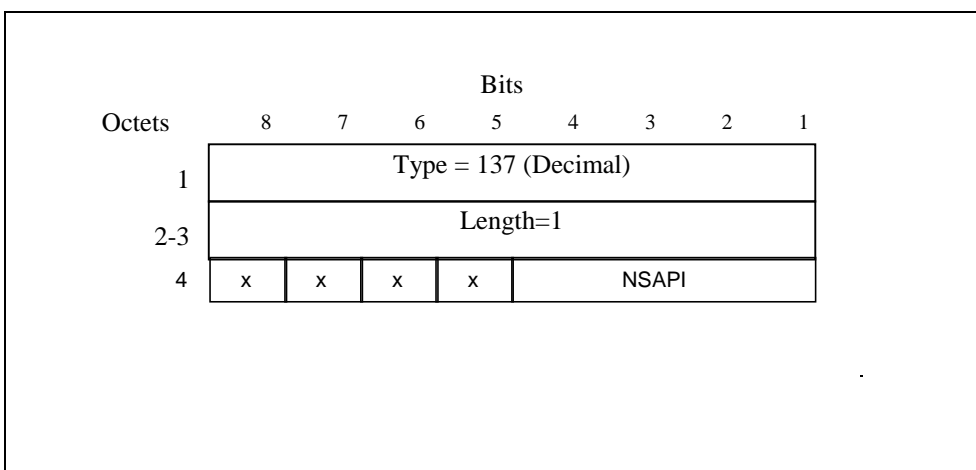

Figure 49: RAB Setup Information information element for release of resources

3G CHANGE REQUEST

Please see embedded help file at the bottom of this page for instructions on how to fill in this form correctly.

29.060

CR 091r1

Current Version: **3.4.0**

3G specification number ↑

↑ CR number as allocated by 3G support team

For submission to TSG **CN#08**
list TSG meeting no. here ↑

For approval (only one box should
For information be marked with an X)

Form: 3G CR cover sheet, version 1.0 The latest version of this form is available from: ftp://ftp.3gpp.org/Information/3GCRF-xx.rtf

Proposed change affects:
(at least one should be marked with an X)

USIM

ME

UTRAN

Core Network

Source: **N4**

Date: **28/03/2000**

Subject: **Change of the length of TI**

3G Work item: **GTP enhancements**

Category:

- F Correction
A Corresponds to a correction in a 2G specification
B Addition of feature
C Functional modification of feature
D Editorial modification

*(only one category
Shall be marked
With an X)*

Reason for change:

N1 decided to introduce an extension mechanism for Transaction Identifier (TI) into R99 SM protocol and that is specified in their latest specification, 24.007 Ver 3.2.0. According to the mechanism, the length of TI in the SM message is 4 or 12 bit. This change has to be reflected to the TI field of the PDP context information element in 29.060.

Clauses affected: **7.7.19**

Other specs

Affected:

- Other 3G core specifications → List of CRs:
Other 2G core specifications → List of CRs:
MS test specifications → List of CRs:
BSS test specifications → List of CRs:
O&M specifications → List of CRs:

Other comments:



help.doc

<----- double-click here for help and instructions on how to create a CR.

7.7.19 PDP Context

The PDP Context information element contains the Session Management parameters, defined for an external packet data network address, that are necessary to transfer between SGSNs at the Inter SGSN Routing Area Update procedure.

NSAPI is an integer value in the range [0; 15].

The NSAPI points out the affected PDP context.

The SAPI indicates the LLC SAPI which is associated with the NSAPI.

Transaction Identifier is the 4 or 12 bit Transaction Identifier used in the ~~GSM-3G TS 024.008~~ Session Management messages which control this PDP Context. If the length of the Transaction Identifier is 4 bit, the second octet shall be set to all zeros. The encoding is defined in 3G TS 24.007.

Reordering Required (Order) indicates whether the SGSN shall reorder T-PDUs before delivering the T-PDUs to the MS.

VPLMN Address Allowed (VAA) indicates whether the MS is allowed to use the APN in the domain of the HPLMN only, or additionally the APN in the domain of the VPLMN.

QoS Sub Length, QoS Req Length and QoS Neg Length represent respectively the lengths of the QoS Sub, QoS Req and QoS Neg fields, excluding the QoS Length octet.

Quality of Service Subscribed (QoS Sub), Quality of Service Requested (QoS Req) and Quality of Service Negotiated (QoS Neg) are encoded as described in section 'Quality of Service (QoS) Profile'.

The Sequence Number Down is the number of the next T-PDU that shall be sent from the new SGSN to the MS. The number is associated to the Sequence Number from the GTP Header of an encapsulated T-PDU.

The Sequence Number Up is the number that new SGSN shall use as the Sequence Number in the GTP Header for the next encapsulated T-PDU from the MS to the GGSN.

The Send N-PDU Number is used only when acknowledged peer-to-peer LLC operation is used for the PDP context. The Send N-PDU Number is the N-PDU number to be assigned by SNDCP to the next downlink N-PDU received from the GGSN. It shall be set to 255 if unacknowledged peer-to-peer LLC operation is used for the PDP context.

The Receive N-PDU Number is used only when acknowledged peer-to-peer LLC operation is used for the PDP context. The Receive N-PDU Number is the N-PDU number expected by SNDCP from the next uplink N-PDU to be received from the MS. It shall be set to 255 if unacknowledged peer-to-peer LLC operation is used for the PDP context.

The Uplink Tunnel Endpoint Identifier Signalling is the Tunnel Endpoint Identifier used between the old SGSN and the GGSN in uplink direction for signalling purpose. It shall be used by the new SGSN within the GTP header of the Update PDP Context Request message.

The PDP Type Organization and PDP Type Number are encoded as in the End User Address information element.

The PDP Address Length represents the length of the PDP Address field, excluding the PDP Address Length octet.

The PDP Address is an octet array with a format dependent on the PDP Type. The PDP Address is encoded as in the End User Address information element if the PDP Type is IPv4, IPv6 or X.25.

The GGSN Address Length represents the length of the GGSN Address field, excluding the GGSN Address Length octet.

The old SGSN includes the GGSN Address for signalling that it has received from GGSN at PDP context activation or update.

The APN is the APN in use in the old SGSN. I.e. the APN sent in the Create PDP Context request message.

The spare bits x indicate unused bits which shall be set to 0 by the sending side and which shall not be evaluated by the receiving side.

1	Type = 130 (Decimal)				
2-3	Length				
4	Res- rved	AA	Res- rved	rder	NSAPI
5	X	X	X	X	SAPI
6	QoS Sub Length				
7 - (q+6)	QoS Sub [3..15]				
q+7	QoS Req Length				
(q+8)- (2q+7)	QoS Req [3..15]				
2q+8	QoS Neg. Length				
(2q+9)- (3q+8)	QoS Neg [3..15]				
(3q+9)- (3q+10)	Sequence Number Down (SND)				
(3q+11)- (3q+12)	Sequence Number Up (SNU)				
3q+13	Send N-PDU Number				
3q+14	Receive N-PDU Number				
(3q+15)- (3q+18)	Uplink Tunnel Endpoint Identifier Signalling				
3q+19	Spare 1 1 1 1			PDP Type Organization	
3q+20	PDP Type Number				
3q+21	PDP Address Length				
(3q+22)-m	PDP Address [1..63]				
m+1	GGSN Address for signalling Length				
(m+2)-n	GGSN Address for signalling [4..16]				
n+1	APN length				
(n+2)-o	APN				
o+1	Spare (sent as 0 0 0 0)			Transaction Identifier	
o+2	Transaction Identifier				

Figure 33: PDP Context information element

Table 46: Reordering Required values

Reordering Required	Value (Decimal)
No	0
Yes	1

Table 47: VPLMN Address Allowed values

VPLMN Address Allowed	Value (Decimal)
No	0
Yes	1

Charleston, U.S.A., 25-25 March 2000

3G CHANGE REQUEST

Please see embedded help file at the bottom of this page for instructions on how to fill in this form correctly.

29.060 CR 093r2

Current Version: **3.4.0**

3G specification number ↑

↑ CR number as allocated by 3G support team

For submission to TSG **CN#08**
list TSG meeting no. here ↑

For approval (only one box should be marked with an X)
For information

Form: 3G CR cover sheet, version 1.0 The latest version of this form is available from: ftp://ftp.3gpp.org/Information/3GCRF-xx.rtf

Proposed change affects:
(at least one should be marked with an X)

USIM

ME

UTRAN

Core Network

Source: **N4**

Date: **29/03/2000**

Subject: **Clarification on the TEID handling**

3G Work item: **GTP enhancement**

Category:
(only one category shall be marked With an X)

- F Correction
- A Corresponds to a correction in a 2G specification
- B Addition of feature
- C Functional modification of feature
- D Editorial modification

R'99

Reason for change:

In the TSG CN#7, the CR on Clarification on the use of TEID in the GTP header (NP-000165, originally N2B000408) was approved. However some ambiguities remain on the handling of the TEID signalling. The purpose of this CR is to clarify these.

Clauses affected: **7.3.1, 7.3.2, 7.3.3, 7.3.4, 7.3.12, 8.2**

Other specs Affected:

- Other 3G core specifications → List of CRs:
- Other 2G core specifications → List of CRs:
- MS test specifications → List of CRs:
- BSS test specifications → List of CRs:
- O&M specifications → List of CRs:

Other comments:



help.doc

<----- double-click here for help and instructions on how to create a CR.

7.3.1 Create PDP Context Request

A Create PDP Context Request shall be sent from a SGSN node to a GGSN node as a part of the GPRS PDP Context Activation procedure. The GGSN IP address where the SGSN sends the Create PDP Context Request is the first IP address in the list of IP addresses provided by the DNS server. After sending the Create PDP Context Request message, the SGSN marks the PDP context as 'waiting for response'. In this state the SGSN shall accept G-PDUs from the GGSN but shall not send these G-PDUs to the MS. A valid request initiates the creation of a tunnel between a PDP Context in a SGSN and a PDP Context in a GGSN. If the procedure is not successfully completed, the SGSN repeats the Create PDP Context Request message to the next GGSN address in the list of IP addresses, if there is one. If the list is exhausted the activation procedure fails.

The Tunnel Endpoint Identifier for Data (I) field specifies a downlink Tunnel Endpoint Identifier for G-PDUs which is chosen by the SGSN. The GGSN shall include this Tunnel Endpoint Identifier in the GTP header of all subsequent downlink G-PDUs which are related to the requested PDP context.

The Tunnel Endpoint Identifier for Signalling field specifies a downlink Tunnel Endpoint Identifier for signalling messages which is chosen by the SGSN. The GGSN shall include this Tunnel Endpoint Identifier in the GTP header of all subsequent downlink signalling messages which are related to the requested PDP context. ~~This field shall not be present if there already exists a signalling tunnel for the given MS between the peer GSNs.~~ If the SGSN has already confirmed successful assignment of its Tunnel Endpoint Identifier for Signalling to the peer GGSN, this field shall not be present. The SGSN confirms successful assignment of its Tunnel Endpoint Identifier for Signalling to the GGSN when it receives any message with its assigned Tunnel Endpoint Identifier for Signalling in the GTP header from the GGSN.

The MSISDN of the MS is passed to the GGSN inside the Create PDP Context Request; This additional information can be used when a secure access to a remote application residing on a server is needed. The GGSN would be in fact able to provide the user identity (i. e. the MSISDN) to the remote application server, providing it with the level of trust granted to users through successfully performing the GPRS authentication procedures, without having to re-authenticate the user at the application level.

If the MS requests a dynamic PDP address and a dynamic PDP address is allowed, then the PDP Address field in the End User Address information element shall be empty. If the MS requests a static PDP Address then the PDP Address field in the End User Address information element shall contain the static PDP Address. In case the PDP addresses carried in the End User Address and optionally in the Protocol Configuration Option information element contain contradicting information, the PDP address carried in the End User Address information element takes the higher precedence. The Quality of Service Profile information element shall be the QoS values to be negotiated between the MS and the SGSN at PDP Context activation.

The SGSN shall include an SGSN Address for signalling and an SGSN address for user traffic, which may differ from that provided by the underlying network service (e.g. IP). The GGSN shall store these SGSN Addresses and use them when sending signalling on this GTP tunnel or G-PDUs to the SGSN for the MS.

The SGSN shall include a Recovery information element into the Create PDP Context Request if the SGSN is in contact with the GGSN for the very first time or if the SGSN has restarted recently and the new Restart Counter value has not yet been indicated to the GGSN. The GGSN that receives a Recovery information element in the Create PDP Context Request message element shall handle it in the same way as when receiving an Echo Response message. The Create PDP Context Request message shall be considered as a valid activation request for the PDP context included in the message.

The SGSN shall include either the MS provided APN, a subscribed APN or an SGSN selected APN in the message; the Access Point Name may be used by the GGSN to differentiate accesses to different external networks. The Selection Mode information element shall indicate the origin of the APN in the message.

For contexts created by the Secondary PDP Context Activation Procedure the SGSN shall include the linked NSAPI. Linked NSAPI indicates the NSAPI assigned to any one of the already activated PDP contexts for this PDP address and APN.

The Secondary PDP Context Activation Procedure may be executed without providing a Traffic Flow Template (TFT) to the newly activated PDP context if all other active PDP contexts for this PDP address and APN already have an associated TFT, otherwise a TFT shall be provided. TFT is used for packet filtering in the GGSN.

When using the Secondary PDP Context Activation Procedure, the Selection mode, MSISDN, End User Address, Access Point Name and Protocol Configuration Options information elements shall not be included in the message.

The optional Protocol Configuration Options information element is applicable for the end user protocol 'IP' only.

The SGSN shall select one GGSN based on the user provided or SGSN selected APN. The GGSN may have a logical name that is converted to an address. The conversion may be performed with any name-to-address function. The converted address shall be stored in the "GGSN Address in Use" field in the PDP context and be used during the entire lifetime of the PDP context.

NOTE: A DNS query may be used as the name-to-IP address mapping of the GGSN. The IP address returned in the DNS response is then stored in the "GGSN Address in Use" field in the PDP context.

The IMSI information element together with the NSAPI information element uniquely identifies the PDP context to be created.

The SGSN may send a Create PDP Context Request even if the PDP context is already active.

The GGSN shall check if the PDP context already exists for the MS. The existing parameters in the PDP context shall then be replaced with the parameters in the Create PDP Context Request message. If a dynamic PDP address has already been allocated for the existing context, this address should be used and copied to the Create PDP Context Response message.

If the GGSN uses the MNRG flag and the flag is set, the GGSN should treat the Create PDP Context Request as a Note MS Present Request and clear the MNRG flag.

The SGSN shall copy Charging Characteristics from the Subscribed Charging Characteristics if the information is present in the Packet Domain Subscription Data.

The SGSN shall include Trace Reference, Trace Type, Trigger Id, and OMC Identity in the message if GGSN trace is activated. The SGSN shall copy Trace Reference, Trace Type, and OMC Identity from the trace request received from the HLR or OMC.

The optional Private Extension contains vendor or operator specific information.

Table 4: Information elements in a Create PDP Context Request

Information element	Presence requirement	Reference
IMSI	Conditional	7.7.2
Recovery	Optional	7.7.11
Selection mode	Mandatory	7.7.12
Tunnel Endpoint Identifier for Data (I)	Mandatory	7.7.13
Tunnel Endpoint Identifier for Signalling	Conditional	7.7.14
NSAPI	Mandatory	7.7.17
Linked NSAPI	Conditional	7.7.17
Charging Characteristics	Optional	7.7.23
Trace Reference	Optional	7.7.24
Trace Type	Optional	7.7.25
End User Address	Conditional	7.7.27
Access Point Name	Conditional	7.7.30
Protocol Configuration Options	Conditional	7.7.31
SGSN Address for signalling	Mandatory	GSN Address 7.7.32
SGSN Address for user traffic	Mandatory	GSN Address 7.7.32
MSISDN	Conditional	7.7.33
Quality of Service Profile	Mandatory	7.7.34
TFT	Conditional	7.7.36
Trigger Id	Optional	7.7.41
OMC Identity	Optional	7.7.42
Private Extension	Optional	7.7.44

*** Next Change ***

7.3.2 Create PDP Context Response

The message shall be sent from a GGSN node to a SGSN node as a response of a Create PDP Context Request. When the SGSN receives a Create PDP Context Response with the Cause value indicating 'Request Accepted', the SGSN activates the PDP context and may start to forward T-PDUs to/from the MS from/to the external data network.

The Cause value indicates if a PDP context has been created in the GGSN or not. A PDP context has not been created in the GGSN if the Cause differs from 'Request accepted'. Possible Cause values are:

- 'Request Accepted'
- 'No resources available'
- 'All dynamic PDP addresses are occupied'
- 'No memory is available'
- 'Service not supported'
- 'User authentication failed'
- 'System failure'
- 'Semantic error in the TFT operation'
- 'Syntactic error in the TFT operation'
- 'Semantic errors in packet filter(s)'
- 'Syntactic errors in packet filters(s)'
- 'Mandatory IE incorrect'
- 'Mandatory IE missing'
- 'Optional IE incorrect'
- 'Invalid message format'
- 'Version not supported'

'No resources available' indicates e.g. that all dynamic PDP addresses are occupied or no memory is available. 'Service not supported' indicates e.g. when the GGSN does not support the PDP type, PDP address or Access Point Name. 'User authentication failed' indicates that the external packet network has rejected the service requested by the user.

Only the Cause information element, optionally Protocol Configuration Options and optionally the Recovery information element shall be included in the response if the Cause contains another value than 'Request accepted'.

All information elements, except Recovery, Protocol Configuration Options, and Private Extension, are mandatory if the Cause contains the value 'Request accepted'.

The Tunnel Endpoint Identifier for Data (I) field specifies an uplink Tunnel Endpoint Identifier for G-PDUs which is chosen by the GGSN. The SGSN shall include this Tunnel Endpoint Identifier in the GTP header of all subsequent uplink G-PDUs which are related to the requested PDP context.

The Tunnel Endpoint Identifier for Signalling field specifies an uplink Tunnel Endpoint Identifier for signalling messages which is chosen by the GGSN. The SGSN shall include this Tunnel Endpoint Identifier in the GTP header of all subsequent uplink signalling messages which are related to the requested PDP context. This field shall not be present if there already exists a signalling tunnel for the given MS between the peer GSNs. If the GGSN has already confirmed successful assignment of its Tunnel Endpoint Identifier for Signalling to the peer SGSN, this field shall not be present. The GGSN confirms successful assignment of its Tunnel Endpoint Identifier for Signalling to the SGSN when it receives any message with its assigned Tunnel Endpoint Identifier for Signalling in the GTP header from the SGSN.

The GGSN shall include a GGSN Address for signalling and a GGSN address for user traffic, which may differ from that provided by the underlying network service (e.g. IP). The SGSN shall store these GGSN Addresses and use them when sending signalling on this GTP tunnel or G-PDUs to the GGSN for the MS.

If the MS requests a dynamic PDP address and a dynamic PDP address is allowed, then the End User Address information element shall be included and the PDP Address field in the End User Address information element shall contain the dynamic PDP Address allocated by the GGSN. In case the PDP addresses carried in the End User Address and optionally in the Protocol Configuration Option information element contain contradicting information, the PDP address carried in the End User Address information element takes the higher precedence.

The QoS values supplied in the Create PDP Context Request may be negotiated downwards by the GGSN. The negotiated values or the original values from SGSN are inserted in the Quality of Service Profile information element of the Create PDP Context Response message.

If a connection-less path is to be used to tunnel T-PDUs for the given PDP context or a reliable connection-oriented path is to be used and a connection already exists, the GGSN may start to forward T-PDUs after the Create PDP Context Response has been sent and the SGSN may start to forward T-PDUs when the Create PDP Context Response has been received. In this case the SGSN shall also be prepared to receive T-PDUs from the GGSN after it has sent a Create PDP Context Request but before a Create PDP Context Response has been received.

If a reliable connection-oriented path is to be used to tunnel T-PDUs for the given PDP context and a connection does not exist between the GSN pair, the SGSN shall establish a connection and the GGSN shall wait for the connection before forwarding of T-PDUs may start.

Only one connection shall be used between any given GSN-pair, and this connection shall be used to tunnel end user traffic in both directions.

The Reordering Required value supplied in the Create PDP Context Response indicates whether the end user protocol benefits from packet in sequence delivery and whether the SGSN and the GGSN therefore shall perform reordering or not, i.e. if reordering is required by the GGSN the SGSN and the GGSN shall perform reordering of incoming T-PDUs on this path. When the Quality of Service (QoS) Profile is Release 99, the Reordering Required shall be ignored by receiving entity.

The GGSN shall include the Recovery information element into the Create PDP Context Response if the GGSN is in contact with the SGSN for the first time or the GGSN has restarted recently and the new Restart Counter value has not yet been indicated to the SGSN. The SGSN receiving the Recovery information element shall handle it as when an Echo Response message is received but shall consider the PDP context being created as active if the response indicates a successful context activation at the GGSN.

The Charging ID is used to identify all charging records produced in SGSN(s) and the GGSN for this PDP context. The Charging ID is generated by the GGSN and shall be unique within the GGSN.

The Charging Gateway Address is the IP address of the recommended Charging Gateway Functionality to which the SGSN should transfer the Charging Detail Records (CDR) for this PDP Context.

The optional Private Extension contains vendor or operator specific information.

Table 5: Information elements in a Create PDP Context Response

Information element	Presence requirement	Reference
Cause	Mandatory	7.7.1
Reordering required	Conditional	7.7.6
Recovery	Optional	7.7.11
Tunnel Endpoint Identifier for Data (I)	Conditional	7.7.13
Tunnel Endpoint Identifier for Signalling	Conditional	7.7.14
Charging ID	Conditional	7.7.26
End user address	Conditional	7.7.27
Protocol Configuration Options	Optional	7.7.31
GGSN Address for signalling	Conditional	GSN Address 7.7.32
GGSN Address for user traffic	Conditional	GSN Address 7.7.32
Quality of Service Profile	Conditional	7.7.34
Charging Gateway Address	Optional	7.7.43
Private Extension	Optional	7.7.44

*** Next Change ***

7.3.3 Update PDP Context Request

An Update PDP Context Request message shall be sent from a SGSN to a GGSN as part of the GPRS Inter SGSN Routeing Update procedure or the PDP Context Modification procedure or to redistribute contexts due to load sharing. It shall be used to change the QoS and the path. The message shall be sent by the new SGSN at the Inter SGSN Routeing Update procedure.

The NSAPI information element together with the Tunnel Endpoint Identifier in the GTP header unambiguously identifies a PDP Context in the GGSN.

The Tunnel Endpoint Identifier for Data (I) field specifies a downlink Tunnel Endpoint Identifier for G-PDUs which is chosen by the SGSN. The GGSN shall include this Tunnel Endpoint Identifier in the GTP header of all subsequent downlink G-PDUs which are related to the requested PDP context.

The Tunnel Endpoint Identifier for Signalling field specifies a downlink Tunnel Endpoint Identifier for signalling messages which is chosen by the SGSN. The GGSN shall include this Tunnel Endpoint Identifier in the GTP header of all subsequent downlink signalling messages which are related to the requested PDP context. ~~This field shall not be present if there already exists a signalling tunnel for the given MS between the peer GSNs.~~ If the SGSN has already confirmed successful assignment of its Tunnel Endpoint Identifier for Signalling to the peer GGSN, this field shall not be present. The SGSN confirms successful assignment of its Tunnel Endpoint Identifier for Signalling to the GGSN when it receives any message with its assigned Tunnel Endpoint Identifier for Signalling in the GTP header from the GGSN.

The Quality of Service Profile information element shall include the QoS negotiated between the MS and SGSN at PDP Context activation or the new QoS negotiated in the PDP Context Modification procedure.

The SGSN shall include an SGSN Address for signalling and an SGSN address for user traffic, which may differ from that provided by the underlying network service (e.g. IP). The GGSN shall store these SGSN Addresses and use them when sending subsequent signalling on this GTP tunnel or G-PDUs to the SGSN for the MS. When active contexts are being redistributed due to load sharing, G-PDUs that are in transit across the Gn-interface are in an undetermined state and may be lost.

The SGSN shall include a Recovery information element into the Update PDP Context Request if the SGSN is in contact with the GGSN for the very first time or if the SGSN has restarted recently and the new Restart Counter value has not yet been indicated to the GGSN. The GGSN that receives a Recovery information element in the Update PDP Context Request message element shall handle it in the same way as when receiving an Echo Response message. The Update PDP Context Request message shall be considered as a valid update request for the PDP context indicated in the message.

The Traffic Flow Template (TFT) is used to distinguish between different user traffic flows.

The SGSN shall include Trace Reference, Trace Type, Trigger Id, and OMC Identity in the message if GGSN trace is activated. The SGSN shall copy Trace Reference, Trace Type, and OMC Identity from the trace request received from the HLR or OMC.

The optional Private Extension contains vendor or operator specific information.

Table 6: Information elements in an SGSN-initiated Update PDP Context Request

Information element	Presence requirement	Reference
Recovery	Optional	7.7.11
Tunnel Endpoint Identifier <u>for</u> Data (I)	Mandatory	7.7.13
Tunnel Endpoint Identifier <u>for</u> Signalling	Conditional	7.7.14
NSAPI	Mandatory	7.7.17
Trace Reference	Optional	7.7.24
Trace Type	Optional	7.7.25
SGSN Address for signalling	Mandatory	GSN Address 7.7.32
SGSN Address for user traffic	Mandatory	GSN Address 7.7.32
Quality of Service Profile	Mandatory	7.7.34
TFT	Optional	7.7.36
Trigger Id	Optional	7.7.41
OMC Identity	Optional	7.7.42
Private Extension	Optional	7.7.44

An Update PDP Context Request may also be sent from a GGSN to a SGSN to re-negotiate the QoS of a PDP context. This GGSN-initiated Update PDP Context Request can also be used to provide a PDP address to the SGSN (and MS). The latter shall be used by GGSN when it acts as a DHCP Relay Agent or Mobil IP Foreign Agent.

The Quality of Service Profile information element shall include the GGSN requested QoS.

The End User Address information element shall contain a valid IPv4 or IPv6 address.

The GGSN shall include a Recovery information element into the Update PDP Context Request if the GGSN has restarted recently and the new Restart Counter value has not yet been indicated to the SGSN. The SGSN that receives a Recovery information element in the Update PDP Context Request message element shall handle it in the same way as when receiving an Echo Response message. The Update PDP Context Request message shall be considered as a valid update request for the PDP context indicated in the message.

The NSAPI information element together with the Tunnel Endpoint Identifier in the GTP header unambiguously identifies a PDP Context in the SGSN.

The optional Private Extension contains vendor or operator specific information.

Table 7: Information elements in a GGSN-initiated Update PDP Context Request

Information element	Presence requirement	Reference
Recovery	Optional	7.7.11
NSAPI	Mandatory	7.7.17
End User Address	Optional	7.7.27
Quality of Service Profile	Optional	7.7.34
Private Extension	Optional	7.7.44

*** *Next Change* ***

7.3.4 Update PDP Context Response

The message shall be sent from a GGSN node to a SGSN node as a response of an Update PDP Context Request.

If the SGSN receives an Update PDP Context Response with a Cause value other than 'Request accepted', it shall deactivate the PDP context.

Only the Cause information element and optionally the Recovery information element shall be included in the response if the Cause contains another value than 'Request accepted'.

Possible Cause values are:

- 'Request Accepted'

- 'Non-existent'
- 'Service not supported'
- 'System failure'
- 'Semantic error in the TFT operation'
- 'Syntactic error in the TFT operation'
- 'Semantic errors in packet filter(s)'
- 'Syntactic errors in packet filters(s)'
- 'Mandatory IE incorrect'
- 'Mandatory IE missing'
- 'Optional IE incorrect'
- 'Invalid message format'
- 'Version not supported'

The Tunnel Endpoint Identifier for Data (I) field specifies an uplink Tunnel Endpoint Identifier for G-PDUs which is chosen by the GGSN. The SGSN shall include this Tunnel Endpoint Identifier in the GTP header of all subsequent uplink G-PDUs which are related to the requested PDP context.

The Tunnel Endpoint Identifier for Signalling field specifies an uplink Tunnel Endpoint Identifier for signalling messages which is chosen by the GGSN. The SGSN shall include this Tunnel Endpoint Identifier in the GTP header of all subsequent uplink signalling messages which are related to the requested PDP context. ~~This field shall not be present if there already exists a signalling tunnel for the given MS between the peer GGSNs.~~ If the GGSN has already confirmed successful assignment of its Tunnel Endpoint Identifier for Signalling to the peer SGSN, this field shall not be present. The GGSN confirms successful assignment of its Tunnel Endpoint Identifier for Signalling to the SGSN when it receives any message with its assigned Tunnel Endpoint Identifier for Signalling in the GTP header from the SGSN.

The QoS values supplied in the Update PDP Context Request may be negotiated downwards by the GGSN. The negotiated values or the original value from SGSN is inserted in the Quality of Service Profile information element. This information element shall be included if the Cause contains the value 'Request accepted'.

If a connection-less path is to be used to tunnel T-PDUs for the given PDP context or a reliable connection-oriented path is to be used and a connection already exists, the GGSN may start to forward T-PDUs after the Update PDP Context Response has been sent and the SGSN may start to forward T-PDUs when the Update PDP Context Response has been received. In this case the SGSN shall also be prepared to receive T-PDUs from the GGSN after it has sent a Update PDP Context Request but before an Update PDP Context Response has been received.

If a reliable connection-oriented path is to be used to tunnel T-PDUs for the given PDP context and a connection does not exist between the GSN pair, the SGSN shall establish a connection and the GGSN shall wait for the connection before forwarding of T-PDUs may start.

Only one connection shall be used between any given GSN-pair, and this connection shall be used to tunnel end user traffic in both directions.

The GGSN shall include a GGSN Address for signalling and an GGSN address for user traffic, which may differ from that provided by the underlying network service (e.g. IP). The SGSN shall store these GGSN Addresses and use them when sending subsequent signalling on this GTP tunnel or G-PDUs to the GGSN for the MS. When active contexts are being redistributed due to load sharing, G-PDUs that are in transit across the Gn-interface are in an undetermined state and may be lost.

The GGSN shall include the Recovery information element into the Update PDP Context Response if the GGSN is in contact with the SGSN for the first time or if the GGSN has restarted recently and the new Restart Counter value has not yet been indicated to the SGSN. The SGSN receiving the Recovery information element shall handle it as when an Echo Response message is received but shall consider the PDP context as updated and active if the response cause indicates a successful operation at the GGSN.

The Charging ID is used to identify all charging records produced in SGSN(s) and the GGSN for this PDP context. The Charging ID has been previously generated by the GGSN and is unique for this PDP context. If an inter-SGSN routing area update occurs, it is transferred to the new SGSN as part of each active PDP context.

The Charging Gateway Address is the IP address of the recommended Charging Gateway Functionality to which the SGSN should transfer the Charging Detail Records (CDR) for this PDP Context.

The optional Private Extension contains vendor or operator specific information.

Table 8: Information elements in an Update PDP Context Response sent by a GGSN

Information element	Presence requirement	Reference
Cause	Mandatory	7.7.1
Recovery	Optional	7.7.11
Tunnel Endpoint Identifier for Data (I)	Conditional	7.7.13
Tunnel Endpoint Identifier for Signalling	Conditional	7.7.14
Charging ID	Conditional	7.7.26
GGSN Address for signalling	Conditional	GSN Address 7.7.32
GGSN Address for user traffic	Conditional	GSN Address 7.7.32
Quality of Service Profile	Conditional	7.7.34
Charging Gateway Address	Optional	7.7.43
Private Extension	Optional	7.7.44

The message can also be sent from a SGSN node to a GGSN node as a response of a GGSN-initiated Update PDP Context Request.

If the GGSN receives an Update PDP Context Response with a Cause value other than 'Request accepted', it shall abort the update of the PDP context.

Only the Cause information element and optionally the Recovery information element shall be included in the response if the Cause contains another value than 'Request accepted'.

Possible Cause values are the same as for the Update PDP Context Response sent by a GGSN.

The QoS values supplied in the Update PDP Context Request may be negotiated downwards by the SGSN. The negotiated values or the original value from GGSN is inserted in the Quality of Service Profile information element. This information element shall be included if the Cause contains the value 'Request accepted' and a QoS information element was supplied in the corresponding request message.

The SGSN shall include the Recovery information element into the Update PDP Context Response if the SGSN has restarted recently and the new Restart Counter value has not yet been indicated to the GGSN. The GGSN receiving the Recovery information element shall handle it as when an Echo Response message is received but shall consider the PDP context as updated and active if the response cause indicates a successful operation at the SGSN.

Table 9: Information elements in an Update PDP Context Response sent by a SGSN

Information element	Presence requirement	Reference
Cause	Mandatory	7.7.1
Recovery	Optional	7.7.11
Quality of Service Profile	Conditional	7.7.34
Private Extension	Optional	7.7.44

*** *Next Change* ***

7.3.8 PDU Notification Request

When receiving a T-PDU the GGSN checks if a PDP context is established for that PDP address. If no PDP context has been previously established, the GGSN may try to deliver the T-PDU by initiating the Network-Requested PDP Context Activation procedure. The criteria, used by the GGSN to determine whether trying to deliver the T-PDU to the MS or not, may be based on subscription information in the GGSN and are outside the scope of GPRS standardisation.

As part of the Network-Requested PDP Context Activation procedure the GGSN sends a PDU Notification Request message to the SGSN indicated by the HLR, i.e. the current location of the MS. When receiving this message, the SGSN shall be responsible for requesting the MS to activate the indicated PDP Context.

The IMSI is inserted in the IMSI information element in the PDU Notification Request message.

The End User Address information element contains the PDP type and PDP address that the SGSN shall request the MS to activate.

The Access Point Name information element identifies the access point of packet data network that wishes to connect to the MS.

The Tunnel Endpoint Identifier for Signalling information element shall be a tunnel endpoint identifier signalling selected by the GGSN and shall be used by the SGSN in the GTP header of the corresponding PDU Notification Response or PDU Notification Request Reject message. ~~This field shall not be present if there already exists a signalling tunnel for the given MS between the peer GSNs.~~ If the GGSN has already confirmed successful assignment of its Tunnel Endpoint Identifier for Signalling to the peer SGSN, this field shall not be present. The GGSN confirms successful assignment of its Tunnel Endpoint Identifier for Signalling to the SGSN when it receives any message with its assigned Tunnel Endpoint Identifier for Signalling in the GTP header from the SGSN.

If the GGSN receives a Create PDP Context Request before the PDU Notification Response, the GGSN shall handle the Create PDP Context Request as a normal context activation and ignore the following PDU Notification Response.

If the SGSN receives a PDU Notification Request after a Create PDP Context Request has been sent but before a Create PDP Context Response has been received, the SGSN shall only send a PDU Notification Response with Cause 'Request accepted' without any further processing and then wait for the Create PDP Context Response.

The optional Private Extension contains vendor or operator specific information.

Table 17: Information elements in a PDU Notification Request

Information element	Presence requirement	Reference
IMSI	Mandatory	7.7.2
Tunnel Endpoint Identifier <u>for</u> Signalling	Conditional	7.7.14
End User Address	Mandatory	7.7.27
Access Point Name	Mandatory	7.7.30
Private Extension	Optional	7.7.44

*** *Next Change* ***

8.2 Usage of the GTP-C Header

For signalling messages the GTP header shall be used as follows:

- Version shall be set to decimal 1 ('001').
- Protocol Type (PT) shall be set to '1'.
- (S) shall be set to '1'.
- PN shall be set to '0'.
- Message Type shall be set to the unique value that is used for each type of signalling message. Valid message types are marked with a x in the GTP-C column in Table 1.
- Length shall be the length, in octets, of the signalling message excluding the GTP header.
- The Tunnel Endpoint Identifier is set by the sending entity to the value requested by the corresponding entity (SGSN or GGSN); it identifies and points out the MS and its associated context data, except for the following cases:

- The ~~first~~ Create PDP Context Request message for a given MS sent to a specific GGSN shall have the Tunnel Endpoint Identifier set to all zeros if the SGSN has not been assigned a Tunnel Endpoint Identifier for Signalling by the GGSN, since this will be the message that establishes the tunnel in the signalling plane for this specific MS. One exception is the Network Initiated PDP context activation procedure, where the TEID in the Create PDP Context Request shall be set to the TEID requested in the PDU Notification Request.
 - The Identification Request/Response messages where the Tunnel Endpoint Identifier shall be set to all zeros.
 - The SGSN Context Request message where the Tunnel Endpoint Identifier shall be set to all zeros.
 - The Echo Request/Response and Version Not Supported messages where the Tunnel Endpoint Identifier shall be set to all zeros.
 - The Forward Relocation Request message where the Tunnel Endpoint Identifier shall be set to all zeros.
 - The PDU Notification Request message where the Tunnel Endpoint Identifier shall be set to all zeros, except for the case, where the GGSN has already been assigned a Tunnel Endpoint Identifier for Signalling by the peer SGSN, a signalling tunnel is already established for that specific MS.
 - All Location Management messages where the Tunnel Endpoint Identifier shall be set to all zeros.
- Sequence Number shall be a message number valid for a path or a tunnel. Within a given set of contiguous Sequence Numbers from 0 to 65535, a given Sequence Number shall, if used, unambiguously define a GTP signalling request message sent on the path or tunnel (see section Reliable delivery of signalling messages). The Sequence Number in a signalling response message shall be copied from the signalling request message that the GSN is replying to.
 - N-PDU Number shall not be present.

The GTP header may be followed by subsequent information elements dependent on the type of signalling message. Only one information element of each type is allowed in a single signalling message, except for the Authentication Triplet, the PDP Context and the Tunnel Endpoint Identifier for Data (II) information element where several occurrences of each type are allowed.

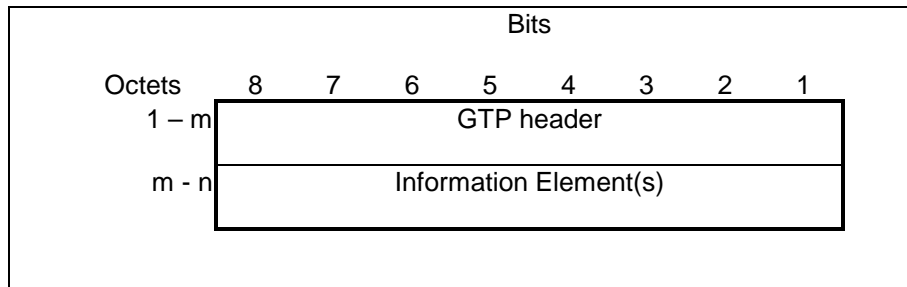

Figure 50: GTP header followed by subsequent Information Elements

CHANGE REQUEST		Please see embedded help file at the bottom of this page for instructions on how to fill in this form correctly.	
29.060	CR	096	Current Version: 3.4.0
GSM (AA.BB) or 3G (AA.BBB) specification number ↑		↑ CR number as allocated by MCC support team	
For submission to: CN#08	for approval <input checked="" type="checkbox"/>	strategic <input type="checkbox"/>	(for SMG use only)
list expected approval meeting # here ↑	for information <input type="checkbox"/>	non-strategic <input checked="" type="checkbox"/>	

Form: CR cover sheet, version 2 for 3GPP and SMG The latest version of this form is available from: <ftp://ftp.3gpp.org/Information/CR-Form-v2.doc>

Proposed change affects: (U)SIM ME UTRAN / Radio Core Network
 (at least one should be marked with an X)

Source: N4 **Date:** 20.3.2000

Subject: Restart counter in Echo response

Work item: GTP enhancements

Category:	F Correction <input checked="" type="checkbox"/> A Corresponds to a correction in an earlier release <input type="checkbox"/> B Addition of feature <input type="checkbox"/> C Functional modification of feature <input type="checkbox"/> D Editorial modification <input type="checkbox"/>	Release:	Phase 2 <input type="checkbox"/> Release 96 <input type="checkbox"/> Release 97 <input type="checkbox"/> Release 98 <input type="checkbox"/> Release 99 <input checked="" type="checkbox"/> Release 00 <input type="checkbox"/>
------------------	--	-----------------	--

(only one category shall be marked with an X)

Reason for change:

Restart counter in the Echo response message is used to inform the peer node that a node has experienced a restart. It is unnecessary to use the Restart counter value in both GTP-U and GTP-C, since it is sufficient to use it only in GTP-C. Moreover, at Lu interface RANAP already has a procedure for node restarts.

Therefore it is proposed that the Restart counter value in the Echo Response message is not used in GTP-U.

The CR also proposes some clarifications how to react when Echo response is received.

Clauses affected:

Other specs affected:	Other 3G core specifications <input type="checkbox"/> Other GSM core specifications <input type="checkbox"/> MS test specifications <input type="checkbox"/> BSS test specifications <input type="checkbox"/> O&M specifications <input type="checkbox"/>	→ List of CRs: → List of CRs: → List of CRs: → List of CRs: → List of CRs:	
------------------------------	---	--	--

Other comments:



<----- double-click here for help and instructions on how to create a CR.

2 Normative references

The following documents contain provisions which, through reference in this text, constitute provisions of the present document.

- References are either specific (identified by date of publication, edition number, version number, etc.) or non-specific.
- For a specific reference, subsequent revisions do not apply.
- For a non-specific reference, the latest version applies.
- A non-specific reference to an ETS shall also be taken to refer to later versions published as an EN with the same number.
- For this Release 1998 document, references to GSM documents are for Release 1998 versions (version 7.x.y).

- [1] GSM 01.04: "Digital cellular telecommunications system (Phase 2+); Abbreviations and acronyms".
- [2] GSM 03.03: "Digital cellular telecommunications system (Phase 2+); Numbering, addressing and identification".
- [3] GSM 03.07: "Digital cellular telecommunications system (Phase 2+); Restoration Procedures".
- [4] GSM 03.20: "Digital cellular telecommunications system (Phase 2+); Security related network functions".
- [5] GSM 03.60: "Digital cellular telecommunications system (Phase 2+); General Packet Radio Service (GPRS); Service Description; Stage 2".
- [6] GSM 03.64: "Digital cellular telecommunications system (Phase 2+); General Packet Radio Service (GPRS); Overall description of the GPRS Radio Interface; Stage 2".
- [7] GSM 04.08: "Digital cellular telecommunications system (Phase 2+); Mobile radio interface layer 3 - specification".
- [8] GSM 04.64: "Digital cellular telecommunications system (Phase 2+); Mobile Station - Serving GPRS Support Node (MS-SGSN) Logical Link Control (LLC) Layer Specification".
- [9] GSM 09.02: "Digital cellular telecommunications system (Phase 2+); Mobile Application Part (MAP) specification".
- [10] TS 25.413: "UTRAN Iu interface RANAP signalling".
- [11] STD 0005: "Internet Protocol", J. Postel.
- [12] STD 0006: "User Datagram Protocol", J. Postel.
- [13] STD 0007: "Transmission Control Protocol", J. Postel.
- [14] RFC 1700: "Assigned Numbers", J. Reynolds and J. Postel.
- [15] RFC 2181: "Clarifications to the DNS Specification", R. Elz and R. Bush.
- [16] ITU-T Recommendation X.25: "Interface between data terminal equipment (DTE) and data circuit-terminating equipment (DCE) for terminals operating in the packet mode and connected to public data networks by dedicated circuit".
- [17] ITU-T Recommendation X.121: "International Numbering Plan for Public Data Networks".
- [18] UMTS TS 33.102: "3G Security; Security Architecture".
- [xx] [UMTS TS 23.007: "Restoration Procedures"](#).

7.2.2 Echo Response

The message shall be sent as a response ~~to~~ a received Echo Request.

The Recovery information element contains the local Restart Counter (see section Restoration and Recovery) value for the GSN ~~or RNC~~ that sends the Echo Response message. For GTP-U the Restart Counter value shall not be used, i.e. it shall be set to zero by the sender and shall be ignored by the receiver.

The GSN ~~or RNC~~ that receives an Echo Response from a peer GSN ~~or RNC~~ shall compare the Restart Counter value received with the previous Restart Counter value stored for that peer GSN. If no previous value was stored, the Restart Counter value received in the Echo Response shall be stored for the peer GSN ~~or RNC~~.

~~If the value of a Restart Counter previously stored for a peer GSN or RNC differs from the Restart Counter value received in the Echo Response from that peer GSN or RNC, the GSN or RNC that sent the Echo Response shall be considered as restarted by the GSN that received the Echo Response. The new Restart Counter value received shall be stored by the receiving entity, replacing the value previously stored for the sending GSN or RNC.~~

~~If the sending GSN is an GGSN and the receiving GSN is a SGSN, the SGSN shall consider all PDP contexts using the GGSN as inactive. For further actions of the SGSN refer to UMTS TS 23.007 [xx]. the SGSN shall notify an affected MS next time the MS contacts the SGSN. An affected MS is an MS that has at least one activated PDP context that was using the restarted GGSN.~~

~~If the sending GSN is an SGSN and the receiving GSN is a GGSN, the GGSN shall consider all PDP contexts using the SGSN as inactive. For further actions of the GGSN refer to 3G3G TS 23.007 [xx].~~

~~The SGSN shall consider all PDP contexts using the path as inactive.~~

The optional Private Extension contains vendor or operator specific information.

Table 3: Information elements in an Echo Response

Information element	Presence requirement	Reference
Recovery	Mandatory	7.7.11
Private Extension	Optional	7.7.26

<h2 style="margin: 0;">CHANGE REQUEST</h2>		Please see embedded help file at the bottom of this page for instructions on how to fill in this form correctly.	
29.060 CR 097r1		Current Version: 3.4.0	
GSM (AA.BB) or 3G (AA.BBB) specification number ↑		↑ CR number as allocated by MCC support team	
For submission to: CN#08 <i>list expected approval meeting # here ↑</i>	for approval <input checked="" type="checkbox"/> for information <input type="checkbox"/>	strategic <input type="checkbox"/> non-strategic <input checked="" type="checkbox"/>	(for SMG use only)

Form: CR cover sheet, version 2 for 3GPP and SMG The latest version of this form is available from: <ftp://ftp.3gpp.org/Information/CR-Form-v2.doc>

Proposed change affects: (U)SIM ME UTRAN / Radio Core Network
(at least one should be marked with an X)

Source: N4 **Date:** 28-03-2000

Subject: Clarification on the use of TEID in the GTP-C header

Work item: GTP Enhancements

Category:	F Correction <input checked="" type="checkbox"/> A Corresponds to a correction in an earlier release <input type="checkbox"/> B Addition of feature <input type="checkbox"/> C Functional modification of feature <input type="checkbox"/> D Editorial modification <input type="checkbox"/>	Release:	Phase 2 <input type="checkbox"/> Release 96 <input type="checkbox"/> Release 97 <input type="checkbox"/> Release 98 <input type="checkbox"/> Release 99 <input checked="" type="checkbox"/> Release 00 <input type="checkbox"/>
------------------	--	-----------------	--

(only one category shall be marked with an X)

Reason for change: The TEID in GTP-C header that is present in Relocation Cancel Request message shall be set to all zeros if the old SGSN send this message to the new SGSN before the old SGSN receives Forward Relocation Response message sent from the new SGSN.

Clauses affected: 8.2

Other specs affected:	Other 3G core specifications <input type="checkbox"/> Other GSM core specifications <input type="checkbox"/> MS test specifications <input type="checkbox"/> BSS test specifications <input type="checkbox"/> O&M specifications <input type="checkbox"/>	→ List of CRs: → List of CRs: → List of CRs: → List of CRs: → List of CRs:	
------------------------------	---	--	--

Other comments:



help.doc

<----- double-click here for help and instructions on how to create a CR.

8.2 Usage of the GTP-C Header

For signalling messages the GTP header shall be used as follows:

- Version shall be set to decimal 1 ('001').
- Protocol Type (PT) shall be set to '1'.
- (S) shall be set to '1'.
- PN shall be set to '0'.
- Message Type shall be set to the unique value that is used for each type of signalling message. Valid message types are marked with a x in the GTP-C column in Table 1.
- Length shall be the length, in octets, of the signalling message excluding the GTP header.
- The Tunnel Endpoint Identifier is set by the sending entity to the value requested by the corresponding entity (SGSN or GGSN); ~~it identifies and points out the the MS and its associated context data, except for the following cases:~~
 - The first Create PDP Context Request message for a given MS sent to a specific GGSN shall have the Tunnel Endpoint Identifier set to all zeros, since this will be the message that establishes the tunnel in the signalling plane for this specific MS. One exception is the Network Initiated PDP context activation procedure, where the TEID in the Create PDP Context Request shall be set to the TEID requested in the PDU Notification Request.
 - The Identification Request/Response messages where the Tunnel Endpoint Identifier shall be set to all zeros.
 - The SGSN Context Request message where the Tunnel Endpoint Identifier shall be set to all zeros.
 - The Echo Request/Response and Version Not Supported messages where the Tunnel Endpoint Identifier shall be set to all zeros.
 - The Forward Relocation Request message where the Tunnel Endpoint Identifier shall be set to all zeros.
 - The PDU Notification Request message where the Tunnel Endpoint Identifier shall be set to all zeros, except for the case where a signalling tunnel is already established for that specific MS.
 - The Relocation Cancel Request message where the Tunnel Endpoint Identifier shall be set to all zeros, except for the case where the old SGSN has already been assigned the Tunnel Endpoint Identifier Signalling of the new SGSN.
 - All Location Management messages where the Tunnel Endpoint Identifier shall be set to all zeros.
- Sequence Number shall be a message number valid for a path or a tunnel. Within a given set of contiguous Sequence Numbers from 0 to 65535, a given Sequence Number shall, if used, unambiguously define a GTP signalling request message sent on the path or tunnel (see section Reliable delivery of signalling messages). The Sequence Number in a signalling response message shall be copied from the signalling request message that the GSN is replying to.
- N-PDU Number shall not be present.

The GTP header may be followed by subsequent information elements dependent on the type of signalling message. Only one information element of each type is allowed in a single signalling message, except for the Authentication Triplet, the PDP Context and the Tunnel Endpoint Identifier Data II information element where several occurrences of each type are allowed.

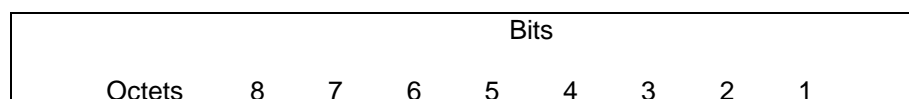

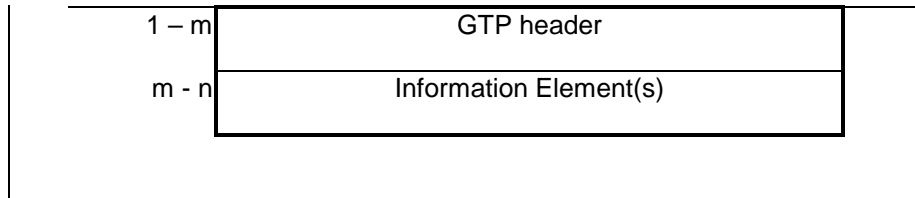

Figure 50: GTP header followed by subsequent Information Elements

CHANGE REQUEST		Please see embedded help file at the bottom of this page for instructions on how to fill in this form correctly.	
29.060 CR 098		Current Version: 3.4.0	
GSM (AA.BB) or 3G (AA.BBB) specification number ↑		↑ CR number as allocated by MCC support team	
For submission to: CN#08 <small>list expected approval meeting # here ↑</small>	for approval <input checked="" type="checkbox"/>	strategic <input type="checkbox"/>	(for SMG use only)
	For information <input type="checkbox"/>	non-strategic <input checked="" type="checkbox"/>	

Form: CR cover sheet, version 2 for 3GPP and SMG The latest version of this form is available from: <ftp://ftp.3gpp.org/Information/CR-Form-v2.doc>

Proposed change affects: (U)SIM ME UTRAN / Radio Core Network
(at least one should be marked with an X)

Source: N4 **Date:** 27 Mar 2000

Subject: Add APN IE for PDU Notification Reject Request message

Work item: GTP enhancements

Category:	F Correction <input checked="" type="checkbox"/>	Release:	Phase 2 <input type="checkbox"/>
(only one category shall be marked with an X)	A Corresponds to a correction in an earlier release <input type="checkbox"/>		Release 96 <input type="checkbox"/>
	B Addition of feature <input type="checkbox"/>		Release 97 <input type="checkbox"/>
	C Functional modification of feature <input type="checkbox"/>		Release 98 <input type="checkbox"/>
	D Editorial modification <input type="checkbox"/>		Release 99 <input checked="" type="checkbox"/>

Reason for change: In a situation that the GGSN receives a PDU Notification Reject Request message as a response when a GGSN sends two PDU Notification messages to a SGSN to terminate to specific MS with both message have a same IP address but different Access Point Name (APN),it is impossible in GGSN to distinguish to which message to be rejected with corresponding APN.
 This CR proposes to add APN parameter to the PDU Notification Reject Request message in order to perform right judgement in GGSN to find corresponding APN with a reject message.

Clauses affected: 7.3.10

Other specs affected:	Other 3G core specifications <input type="checkbox"/>	→ List of CRs:	
	Other GSM core specifications <input type="checkbox"/>	→ List of CRs:	
	MS test specifications <input type="checkbox"/>	→ List of CRs:	
	BSS test specifications <input type="checkbox"/>	→ List of CRs:	
	O&M specifications <input type="checkbox"/>	→ List of CRs:	

Other comments:



help.doc

<----- double-click here for help and instructions on how to create a CR.

7.3.10 PDU Notification Reject Request

If the PDP context activation proceeds after the PDU Notification Response, but the PDP context was not established, the SGSN sends a PDU Notification Reject Request message. The Cause value indicates the reason why the PDP Context could not be established:

- 'MS Not GPRS Responding'.
- 'MS Refuses'.

When receiving the PDU Notification Reject Request message the GGSN may reject or discard the stored T-PDU(s) depending on the PDP type.

After an unsuccessful activation attempt the GSNs may perform some actions to prevent unnecessary enquires to the HLR as described in the section Unsuccessful Network-Requested PDP Context Activation procedure in GSM 03.60.

The Tunnel Endpoint Identifier of the PDU Notification Reject Request message shall be the same as the Tunnel Endpoint Identifier of the PDU Notification Request that triggered the reject.

The End User Address information element contains the PDP type and PDP address of the PDP context that could not be activated.

The Access Point Name shall be the same as the Access Point Name of the received PDU Notification Request message that triggered the reject.

The optional Private Extension contains vendor or operator specific information.

Table 19: Information elements in a PDU Notification Reject Request

Information element	Presence requirement	Reference
Cause	Mandatory	7.7.1
Tunnel Endpoint Identifier Signalling	Mandatory	7.7.14
End User Address	Mandatory	7.7.17
Access Point Name	Mandatory	7.7.30
Private Extension	Optional	7.7.26

CHANGE REQUEST

Please see embedded help file at the bottom of this page for instructions on how to fill in this form correctly.

29.060 CR 099r1

Current Version: **3.4.0**

GSM (AA.BB) or 3G (AA.BBB) specification number ↑

↑ CR number as allocated by MCC support team

For submission to: **CN#08**
list expected approval meeting # here ↑

for approval
for information

strategic
non-strategic (for SMG use only)

Form: CR cover sheet, version 2 for 3GPP and SMG The latest version of this form is available from: <ftp://ftp.3gpp.org/Information/CR-Form-v2.doc>

Proposed change affects:
(at least one should be marked with an X)

(U)SIM ME UTRAN / Radio Core Network

Source: **N4**

Date: **March 27th 2000**

Subject: **Addition of response code Delete PDP Context Response**

Work item: **GTP Enhancements**

Category:
(only one category shall be marked with an X)

F Correction	<input checked="" type="checkbox"/>
A Corresponds to a correction in an earlier release	<input type="checkbox"/>
B Addition of feature	<input type="checkbox"/>
C Functional modification of feature	<input type="checkbox"/>
D Editorial modification	<input type="checkbox"/>

Release:

Phase 2	<input type="checkbox"/>
Release 96	<input type="checkbox"/>
Release 97	<input type="checkbox"/>
Release 98	<input type="checkbox"/>
Release 99	<input checked="" type="checkbox"/>
Release 00	<input type="checkbox"/>

Reason for change:

The list of possible cause values for the Delete PDP Context Response message only contains one value: 'Request Accepted'. However, in R'99 the Delete PDP Context Request has been enhanced with two new parameters Teardown Id and NSAPI.

Therefore, the possible cause values have been updated.

Clauses affected:

Other specs affected:

Other 3G core specifications	<input type="checkbox"/>	→ List of CRs:	
Other GSM core specifications	<input type="checkbox"/>	→ List of CRs:	
MS test specifications	<input type="checkbox"/>	→ List of CRs:	
BSS test specifications	<input type="checkbox"/>	→ List of CRs:	
O&M specifications	<input type="checkbox"/>	→ List of CRs:	

Other comments:

7.3.6 Delete PDP Context Response

The message shall be sent as a response of a Delete PDP Context Request.

A GSN shall ignore a Delete PDP Context Response for a non-existing PDP context.

Possible Cause values are:

- 'Request Accepted'
- 'Mandatory IE incorrect'
- 'Mandatory IE missing'
- 'Optional IE Incorrect'
- 'Invalid message format'

If the received Delete PDP Context Response contains a cause value other than 'Request accepted', the PDP context shall be kept active.

The optional Private Extension contains vendor or operator specific information.

Table 11: Information elements in a Delete PDP Context Response

Information element	Presence requirement	Reference
Cause	Mandatory	7.7.1
Private Extension	Optional	7.7.44

CHANGE REQUEST		Please see embedded help file at the bottom of this page for instructions on how to fill in this form correctly.	
29.060	CR	100r1	Current Version: 3.4.0
GSM (AA.BB) or 3G (AA.BBB) specification number ↑		↑ CR number as allocated by MCC support team	
For submission to: TSG CN#08	for approval <input checked="" type="checkbox"/>	strategic <input type="checkbox"/>	(for SMG use only)
<small>list expected approval meeting # here ↑</small>	for information <input type="checkbox"/>	non-strategic <input checked="" type="checkbox"/>	

Form: CR cover sheet, version 2 for 3GPP and SMG The latest version of this form is available from: <ftp://ftp.3gpp.org/Information/CR-Form-v2.doc>

Proposed change affects: (U)SIM ME UTRAN / Radio Core Network
(at least one should be marked with an X)

Source: Lucent Technologies **Date:** _____

Subject: Introduction of a different port number for GTP-C and GTP-U

Work item: GTP Enhancements

Category:	F Correction <input checked="" type="checkbox"/>	Release:	Phase 2 <input type="checkbox"/>
	A Corresponds to a correction in an earlier release <input type="checkbox"/>		Release 96 <input type="checkbox"/>
(only one category shall be marked with an X)	B Addition of feature <input type="checkbox"/>		Release 97 <input type="checkbox"/>
	C Functional modification of feature <input type="checkbox"/>		Release 98 <input type="checkbox"/>
	D Editorial modification <input type="checkbox"/>		Release 99 <input checked="" type="checkbox"/>
			Release 00 <input type="checkbox"/>

Reason for change:

The separation of the port number for GTP-C and GTP-U allows for distinct processes to handle the two components of GTP even when they are using the same IP address. Introducing the new port number requires updating the procedure used to fall back to GTPv0. This is included in this CR.

Clauses affected: 6, 8, 9.3.1, 10, 11.1.1

Other specs affected:	Other 3G core specifications <input type="checkbox"/>	→ List of CRs:	
	Other GSM core specifications <input type="checkbox"/>	→ List of CRs:	
	MS test specifications <input type="checkbox"/>	→ List of CRs:	
	BSS test specifications <input type="checkbox"/>	→ List of CRs:	
	O&M specifications <input type="checkbox"/>	→ List of CRs:	

Other comments: This CR is a follow-up to Tdoc N2-99E44, approved in Eton



help.doc

<----- double-click here for help and instructions on how to create a CR.

6 GTP header

The GTP header shall be a variable length header used for both the GTP-C and the GTP-U protocols. The minimum length of the GTP header is 8 bytes. There are three flags that are used to signal the presence of additional optional fields: the PN flag, the S flag and the E flag. The PN flag is used to signal the presence of N-PDU Numbers. The S flag is used to signal the presence of the GTP Sequence Number field. The E flag is used to signal the presence of the Extension Header field, used to enable future extensions of the GTP header defined in this document, without the need to use another version number. If any of these three flags are set, the length of the header is at least 12 octets and the fields corresponding to the flags that are set shall be evaluated by the receiver. The sender shall set all the bits of the unused fields to zero. The receiver shall not evaluate the unused fields.

The GTP-C and the GTP-U use some of the fields in the GTP header differently. The different use of such fields is described in the sections related to GTP-C and to GTP-U.

Always present fields:

- Version field: this field is used to determine the version of the GTP protocol. For the treatment of other versions, see section 11.1.1, "Different GTP versions". The version number shall be set to '1'.
- Protocol Type (PT): this bit is used as a protocol discriminator between GTP (when PT is '1') and GTP' (when PT is '0'). GTP is described in this document and the GTP' protocol in GSM 12.15. Note that the interpretation of the header fields may be different in GTP' than in GTP.
- Extension Header flag (E): this flag indicates the presence of the Next Extension Header field when it is set to '1'. When it is set to '0', the Next Extension Header field either is not present or, if present, must not be interpreted.
- Sequence number flag (S): this flag indicates the presence of the Sequence Number field when it is set to '1'. When it is set to '0', the Sequence Number field either is not present or, if present, must not be interpreted. The S flag shall be set to '1' in GTP-C messages.
- N-PDU Number flag (PN): this flag indicates the presence of the N-PDU Number field when it is set to '1'. When it is set to '0', the N-PDU Number field either is not present, or, if present, must not be interpreted. This flag is significant only for GTP-U. As such, this flag is unused by GTP-C and it shall be ignored by a GTP-C receiving entity.
- Message Type: this field indicates the type of GTP message. The valid values of the message type are defined in section 7.1 for both GTP-C and GTP-U.
- Length: this field indicates the length in octets of the payload, i.e. the rest of the packet following the mandatory part of the GTP header (that is the first 8 octets). The Sequence Number, the N-PDU Number or any Extension headers shall be considered to be part of the payload, i.e. included in the length count.
- Tunnel Endpoint Identifier (TEID): this field unambiguously identifies a tunnel endpoint in the receiving GTP-U or GTP-C protocol entity. The receiving end side of a GTP tunnel locally assigns the TEID value the transmitting side has to use. The TEID values are exchanged between tunnel endpoints using GTP-C (or RANAP, over the Iu) messages.

Optional fields:

- Sequence Number: this field is an optional field in GTP-U. It is used as a transaction identity for signalling messages in GTP-C and as an increasing sequence number for T-PDUs, transmitted via GTP-U tunnels, when transmission order must be preserved.
- N-PDU Number: this field is used at the Inter SGSN Routeing Area Update procedure and some SRNS relocation or inter-system handover procedures (e.g. between 2G and 3G radio access networks). This field is used to co-ordinate the data transmission for acknowledged mode of communication between the MS and the SGSN or the SRNC. The exact meaning of this field depends upon the scenario. (For example, for GSM/GPRS to GSM/GPRS, the SNDCP N-PDU number is present in this field, while for UMTS to GSM/GPRS, the PDCP sequence number is present.)
- Next Extension Header Type: this field defines the type of Extension Header that follows this field in the G-PDU.

Octets	Bits							
	8	7	6	5	4	3	2	1
1	Version		PT	(*)	E	S	PN	
2	Message Type							
3	Length (1 st Octet)							
4	Length (2 nd Octet)							
5	Tunnel Endpoint Identifier (1 st Octet)							
6	Tunnel Endpoint Identifier (2 nd Octet)							
7	Tunnel Endpoint Identifier (3 rd Octet)							
8	Tunnel Endpoint Identifier (4 th Octet)							
9	Sequence Number (1 st Octet) ^{1) 4)}							
10	Sequence Number (2 nd Octet) ^{1) 4)}							
11	N-PDU Number ^{2) 4)}							
12	Next Extension Header Type ^{3) 4)}							

(*) This bit is a spare bit. It shall be sent as '0'. The receiver shall not evaluate this bit.

- 1) This field shall only be evaluated when indicated by the S flag.
- 2) This field shall only be evaluated when indicated by the PN flag
- 3) This field shall only be evaluated when indicated by the E flag
- 4) This field shall be present when any one or more of the S, PN and E flags are set.

Figure 2: Outline of the GTP header

***** NEXT CHANGE *****

8 Signalling Plane (GTP-C)

The signalling plane in this case relates to GPRS Mobility Management functions like for example GPRS Attach, GPRS Routing Area Update and Activation of PDP Contexts. The GPRS Tunnelling Protocol-Control plane (GTP-C) shall perform the signalling between GSN nodes.

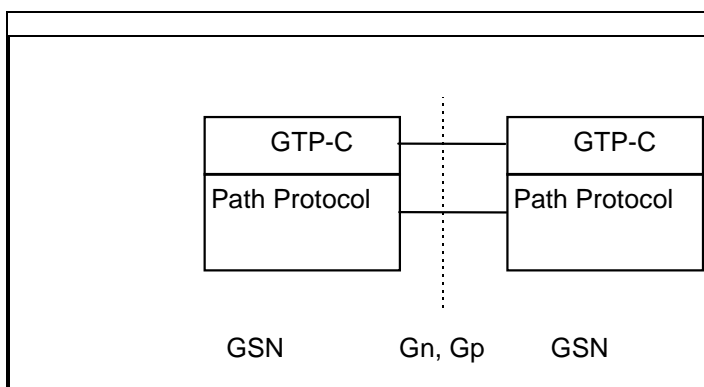

Figure 58: Signalling Plane - Protocol stack

8.1 Signalling protocol

The GTP-C signalling flow shall be logically associated with, but separate from, the GTP-U tunnels. For each GSN-GSN pair one or more paths exist. One or more tunnels may use each path. GTP-C shall be the means by which tunnels are established, used, managed and released. A path may be maintained by keep-alive echo messages. This ensures that a connectivity failure between GSNs can be detected in a timely manner.

8.2 Usage of the GTP-C Header

For signalling messages the GTP header shall be used as follows:

- Version shall be set to decimal 1 ('001').
- Protocol Type (PT) shall be set to '1'.
- (S) shall be set to '1'.
- PN shall be set to '0'. A GTP-C receiver shall ignore this flag.
- Message Type shall be set to the unique value that is used for each type of signalling message. Valid message types are marked with a x in the GTP-C column in Table 1.
- Length shall be the length, in octets, of the signalling message excluding the GTP header.
- The Tunnel Endpoint Identifier is set by the sending entity to the value requested by the corresponding entity (SGSN or GGSN) and points out the MS and its associated context data, except for the following cases:
 - The first Create PDP Context Request message for a given MS sent to a specific GGSN shall have the Tunnel Endpoint Identifier set to all zeros, since this will be the message that establishes the tunnel in the signalling plane for this specific MS. One exception is the Network Initiated PDP context activation procedure, where the TEID in the Create PDP Context Request shall be set to the TEID requested in the PDU Notification Request.
 - The Identification Request/Response messages where the Tunnel Endpoint Identifier shall be set to all zeros.
 - The SGSN Context Request message where the Tunnel Endpoint Identifier shall be set to all zeros.
 - The Echo Request/Response and Version Not Supported messages where the Tunnel Endpoint Identifier shall be set to all zeros.
 - The Forward Relocation Request message where the Tunnel Endpoint Identifier shall be set to all zeros.
 - The PDU Notification Request message where the Tunnel Endpoint Identifier shall be set to all zeros, except for the case where a signalling tunnel is already established for that specific MS.
 - All Location Management messages where the Tunnel Endpoint Identifier shall be set to all zeros.
- Sequence Number shall be a message number valid for a path or a tunnel. Within a given set of contiguous Sequence Numbers from 0 to 65535, a given Sequence Number shall, if used, unambiguously define a GTP signalling request message sent on the path or tunnel (see section Reliable delivery of signalling messages). The Sequence Number in a signalling response message shall be copied from the signalling request message that the GSN is replying to.
- N-PDU Number shall not be present.

The GTP-C header may be followed by subsequent information elements dependent on the type of signalling message. Only one information element of each type is allowed in a single signalling message, except for the Authentication Triplet, the PDP Context and the Tunnel Endpoint Identifier Data II information element where several occurrences of each type are allowed.

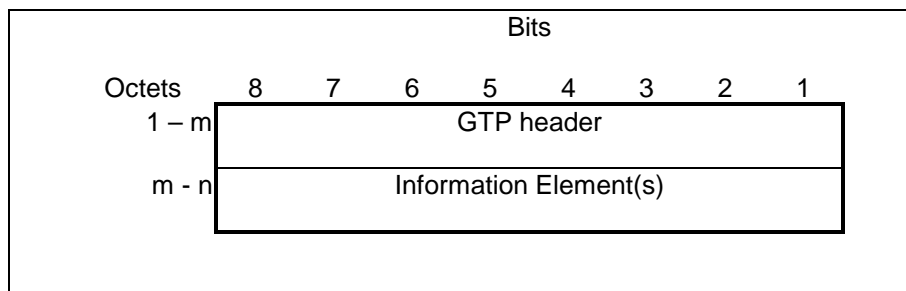

Figure 59: GTP header followed by subsequent Information Elements

***** NEXT CHANGE *****

9.3.1 Usage of the GTP-U Header

The GTP-U header shall be used as follows:

- Version shall be set to decimal 1 ('001').
- Protocol Type (PT) shall be set to '1'.
- If the S field is set to '1' the sequence number field is present otherwise it is set to '0'.
- PN flag: the GTP-U header includes the N-PDU Number field if the PN flag is set to 1.
- Message Type shall be set according to Table 1. The value 255 is used when T-PDUs are transmitted. The value 1 and 2 are used for "Echo" messages. The value 3 for "Version Non Supported" messages.
- Length: Size of the T-PDU excluding the GTP-U header size.
- Sequence Number: This field is present only if the S field is set to 1. The handling of this field is specified in section 9.1.1. It shall be used in order to decide whether or not to discard a received T-PDU, as specified in sub-clause 9.3.1.1 Usage of the Sequence Number.
- N-PDU Number: This field shall be included if and only if the PN flag is set to 1. In this case, the old SGSN (or RNC) uses it, at the Inter SGSN Routing Area Update procedure (or SRNS relocation), to inform the new SGSN (or RNC) of the N-PDU number assigned to T-PDU. If an N-PDU number was not assigned to the T-PDU by PDCP, or if the T-PDU is to be transferred using unacknowledged peer-to-peer LLC operation, then PN shall be set to 0.
- TEID: Contains the Tunnel Endpoint Identifier for the tunnel to which this T-PDU belongs. The TEID shall be used by the receiving entity to find the PDP context.

***** NEXT CHANGE *****

10 Path Protocols

10.1 UDP/IP

UDP/IP is the only path protocol defined to transfer GTP signalling messages in the version 1 of GTP. UDP/IP is also the recommended choice as a connection-less path to tunnel connection-less T-PDUs. A User Datagram Protocol (UDP) compliant with STD 0006 shall be used.

10.1.1 UDP Header

10.1.1.1 Signalling request messages

The UDP Destination Port ~~is the server port number is 21233386. It shall be reserved~~ is the registered port number for GTP-C.

The UDP Source Port is a locally allocated port number at the sending GSN.

10.1.1.2 Signalling response messages

The UDP Destination Port value shall be the value of the UDP Source Port of the corresponding signalling request message.

The UDP Source Port shall be the value from the UDP Destination Port of the corresponding signalling request message.

10.1.1.3 Encapsulated T-PDUs

The UDP Destination Port ~~shall be the server port number 3386~~ shall be 2152. It shall be reserved is the registered port number for GTP-U. The UDP Source Port is a locally allocated port number at the sending GSN.

***** NEXT CHANGE *****

11.1.1 Different GTP versions

If a receiving node receives a GTP signalling message of an unsupported version, that node shall return a GTP Version Not Supported message indicating in the Version field of the GTP header the latest GTP version that that node supports. The received G-PDU shall then be discarded.

A GTP version '0' only GSN is may not be listening on port 2123 and as such it won't be able to send back a Version Not Supported message to a peer trying to establish a dialogue with it using GTP-C. As such, a GSN supporting both version '1' and version '0' shall fall back to version '0' if the attempt to contact a peer using version '1' fails.

It is an implementation option keeping a shortlist of recently contacted version '0' only GSNs, as well of the version supported by those nodes sending back a Version Not Supported message.

<h2 style="margin: 0;">CHANGE REQUEST</h2>			Please see embedded help file at the bottom of this page for instructions on how to fill in this form correctly.	
29.060 CR 105		Current Version: V3.4.0		
GSM (AA.BB) or 3G (AA.BBB) specification number ↑		↑ CR number as allocated by MCC support team		
For submission to: CN#08	for approval <input checked="" type="checkbox"/>	strategic <input type="checkbox"/>	(for SMG use only)	
<small>list expected approval meeting # here ↑</small>	for information <input type="checkbox"/>	non-strategic <input checked="" type="checkbox"/>		

Form: CR cover sheet, version 2 for 3GPP and SMG The latest version of this form is available from: <ftp://ftp.3gpp.org/Information/CR-Form-v2.doc>

Proposed change affects: (U)SIM ME UTRAN / Radio Core Network
(at least one should be marked with an X)

Source: **N4** **Date:** **26 May 2000**

Subject: **Race Conditions Avoidance**

Work item: **GTP Enhancements**

Category: (only one category shall be marked with an X)	F Correction	<input checked="" type="checkbox"/>	Release: Phase 2 <input type="checkbox"/> Release 96 <input type="checkbox"/> Release 97 <input type="checkbox"/> Release 98 <input type="checkbox"/> Release 99 <input checked="" type="checkbox"/> Release 00 <input type="checkbox"/>
	A Corresponds to a correction in an earlier release	<input type="checkbox"/>	
	B Addition of feature	<input type="checkbox"/>	
	C Functional modification of feature	<input type="checkbox"/>	
	D Editorial modification	<input type="checkbox"/>	

Reason for change:

The creation and deletion of PDP contexts as currently defined is prone to race conditions. SGSN sends to GGSN creation of PDP context #2. This message gets lost.

SGSN sends to GGSN deletion of PDP context #1 (the primary and only PDP context already active)

GGSN ACKs deletion of PDP context # 1 and deletes all the context associated to the MS (including the TEID for signaling)

SGSN re-sends to GGSN creation of PDP context #2. The GGSN receives this message, but it is unfortunately populated with stale information (wrong TEID for signaling and linked N-SAPI) .

As a result the user gets unexpectedly disconnected, and the operator may receive complaints. This CR proposes changes to the mechanism that will avoid such situations:

The reason for the problem is that the concept of PDP session needs to be overlaid to the concept of PDP context. In R'98 this was not a problem, since a data session and a PDP contexts were isomorphic. Now, the session may be made of 1 or more PDP contexts. This introduces some problems if we don't explicitly differentiate between tear down of the session or of the PDP context.

Clauses affected: **7.3.5**

Other specs affected:	Other 3G core specifications	<input type="checkbox"/>	→ List of CRs:	
	Other GSM core specifications	<input type="checkbox"/>	→ List of CRs:	
	MS test specifications	<input type="checkbox"/>	→ List of CRs:	
	BSS test specifications	<input type="checkbox"/>	→ List of CRs:	
	O&M specifications	<input type="checkbox"/>	→ List of CRs:	

Other comments: There may be the need to send a LS toS2 and N1



help.doc

<----- double-click here for help and instructions on how to create a CR.

7.3.5 Delete PDP Context Request

A Delete PDP Context Request shall be sent from a SGSN node to a GGSN node as part of the GPRS Detach procedure or the GPRS PDP Context Deactivation procedure or from a GGSN node to a SGSN node as part of the PDP Context Deactivation Initiated by GGSN procedure. A request shall be used to deactivate an activated PDP Context or an activated set of PDP contexts associated to a PDP address assigned to a single MS.

A GSN shall be prepared to receive a Delete PDP Context Request at any time and shall always reply regardless if the PDP context exists or not, except in the case described below.

If any collision occurs, the Delete PDP Context Request takes precedence over any other Tunnel Management message.

The ~~optional~~ Teardown Ind is used to indicate that all PDP contexts that share the PDP address with the PDP context identified in the request should also be deactivated. This may trigger the deletion of all the information kept for a MS at a GSN, if no other PDP contexts associated to other PDP addresses are active on the GSN. This information element shall always be included when the Last PDP context associated to a PDP address is torn down.

If a GSN receives a Delete PDP context without a Teardown Indicator and only that PDP context is active for a PDP address, then the GSN shall ignore the message. (Note: This is symptom of a race condition. The reliable delivery of signalling messages will eventually lead to a consistent situation, allowing the teardown of the PDP context.)

The optional Private Extension contains vendor or operator specific information.

Table 10: Information elements in a Delete PDP Context Request

Information element	Presence requirement	Reference
Teardown Ind	Optional Conditional	7.7.16
NSAPI	Mandatory	7.7.17
Private Extension	Optional	7.7.44

CHANGE REQUEST

Please see embedded help file at the bottom of this page for instructions on how to fill in this form correctly.

29.060 CR 106

Current Version: **3.4.0**

GSM (AA.BB) or 3G (AA.BBB) specification number ↑

↑ CR number as allocated by MCC support team

For submission to: **CN#08**
list expected approval meeting # here ↑

for approval
for information

strategic
non-strategic (for SMG use only)

Form: CR cover sheet, version 2 for 3GPP and SMG The latest version of this form is available from: <ftp://ftp.3gpp.org/Information/CR-Form-v2.doc>

Proposed change affects:
(at least one should be marked with an X)

(U)SIM ME UTRAN / Radio Core Network

Source: **N4**

Date: **26 May 2000**

Subject: **Removal of Connection oriented paths**

Work item: **GTP enhancements**

Category:
(only one category shall be marked with an X)
F Correction
A Corresponds to a correction in an earlier release
B Addition of feature
C Functional modification of feature
D Editorial modification

Release:
Phase 2
Release 96
Release 97
Release 98
Release 99
Release 00

Reason for change: **Since GTPv1 does not include connection oriented TCP protocol, the use of connection oriented path is obsolete. The CR removes any use of connection oriented paths.**

Clauses affected: **7.3.2, 7.3.4, 7.5.5**

Other specs affected:
Other 3G core specifications → List of CRs:
Other GSM core specifications → List of CRs:
MS test specifications → List of CRs:
BSS test specifications → List of CRs:
O&M specifications → List of CRs:

Other comments:



help.doc

<----- double-click here for help and instructions on how to create a CR.

7.3.2 Create PDP Context Response

The message shall be sent from a GGSN node to a SGSN node as a response of a Create PDP Context Request. When the SGSN receives a Create PDP Context Response with the Cause value indicating 'Request Accepted', the SGSN activates the PDP context and may start to forward T-PDUs to/from the MS from/to the external data network.

The Cause value indicates if a PDP context has been created in the GGSN or not. A PDP context has not been created in the GGSN if the Cause differs from 'Request accepted'. Possible Cause values are:

- 'Request Accepted'
- 'No resources available'
- 'All dynamic PDP addresses are occupied'
- 'No memory is available'
- 'Service not supported'
- 'User authentication failed'
- 'System failure'
- 'Semantic error in the TFT operation'
- 'Syntactic error in the TFT operation'
- 'Semantic errors in packet filter(s)'
- 'Syntactic errors in packet filters(s)'
- 'Mandatory IE incorrect'
- 'Mandatory IE missing'
- 'Optional IE incorrect'
- 'Invalid message format'
- 'Version not supported'

'No resources available' indicates e.g. that all dynamic PDP addresses are occupied or no memory is available. 'Service not supported' indicates e.g. when the GGSN does not support the PDP type, PDP address or Access Point Name. 'User authentication failed' indicates that the external packet network has rejected the service requested by the user.

Only the Cause information element, optionally Protocol Configuration Options and optionally the Recovery information element shall be included in the response if the Cause contains another value than 'Request accepted'.

All information elements, except Recovery, Protocol Configuration Options, and Private Extension, are mandatory if the Cause contains the value 'Request accepted'.

The Tunnel Endpoint Identifier Data I field specifies an uplink Tunnel Endpoint Identifier for G-PDUs that is chosen by the GGSN. The SGSN shall include this Tunnel Endpoint Identifier in the GTP header of all subsequent uplink G-PDUs which are related to the requested PDP context.

The Tunnel Endpoint Identifier Signalling field specifies an uplink Tunnel Endpoint Identifier for signalling messages, which is chosen by the GGSN. The SGSN shall include this Tunnel Endpoint Identifier in the GTP header of all subsequent uplink-signalling messages, which are related to the requested PDP context. This field shall not be present if a signalling tunnel already exists for the given MS between the peer GSNs.

The GGSN shall include a GGSN Address for signalling and a GGSN address for user traffic, which may differ from that provided by the underlying network service (e.g. IP). The SGSN shall store these GGSN Addresses and use them when sending signalling on this GTP tunnel or G-PDUs to the GGSN for the MS.

If the MS requests a dynamic PDP address and a dynamic PDP address is allowed, then the End User Address information element shall be included and the PDP Address field in the End User Address information element shall contain the dynamic PDP Address allocated by the GGSN. In case the PDP addresses carried in the End User Address

and optionally in the Protocol Configuration Option information element contain contradicting information, the PDP address carried in the End User Address information element takes the higher precedence.

The QoS values supplied in the Create PDP Context Request may be negotiated downwards by the GGSN. The negotiated values or the original values from SGSN are inserted in the Quality of Service Profile information element of the Create PDP Context Response message.

~~If a connection less (or an already existing reliable connection oriented) path is to be used to tunnel T-PDUs for the given PDP context, the GGSN may start to forward T-PDUs after the Create PDP Context Response has been sent. The SGSN may start to forward T-PDUs when the Create PDP Context Response has been received. In this case the SGSN shall also be prepared to receive T-PDUs from the GGSN after it has sent a Create PDP Context Request but before a Create PDP Context Response has been received.~~

~~If a reliable connection oriented path is to be used to tunnel T-PDUs for the given PDP context and a connection does not exist between the GSN pair, the SGSN shall establish a connection and the GGSN shall wait for the connection before forwarding of T-PDUs may start.~~

~~Only one connection shall be used between any given GSN pair, and this connection shall be used to tunnel end user traffic in both directions.~~

The Reordering Required value supplied in the Create PDP Context Response indicates whether the end user protocol benefits from packet in sequence delivery and whether the SGSN and the GGSN therefore shall perform reordering or not. In other words, if reordering is required by the GGSN, the SGSN and the GGSN shall perform reordering of incoming T-PDUs on this path. When the Quality of Service (QoS) Profile is Release 99, receiving entity shall ignore the Reordering Required.

The GGSN shall include the Recovery information element into the Create PDP Context Response if the GGSN is in contact with the SGSN for the first time or the GGSN has restarted recently and the new Restart Counter value has not yet been indicated to the SGSN. The SGSN receiving the Recovery information element shall handle it as when an Echo Response message is received but shall consider the PDP context being created as active if the response indicates successful context activation at the GGSN.

The Charging ID is used to identify all charging records produced in SGSN(s) and the GGSN for this PDP context. The Charging ID is generated by the GGSN and shall be unique within the GGSN.

The Charging Gateway Address is the IP address of the recommended Charging Gateway Functionality to which the SGSN should transfer the Charging Detail Records (CDR) for this PDP Context.

The optional Private Extension contains vendor or operator specific information.

***** NEXT CHANGE *****

7.3.4 Update PDP Context Response

The message shall be sent from a GGSN node to a SGSN node as a response of an Update PDP Context Request.

If the SGSN receives an Update PDP Context Response with a Cause value other than 'Request accepted', it shall deactivate the PDP context.

Only the Cause information element and optionally the Recovery information element shall be included in the response if the Cause contains another value than 'Request accepted'.

Possible Cause values are:

- 'Request Accepted'
- 'Non-existent'
- 'Service not supported'
- 'System failure'
- 'Semantic error in the TFT operation'
- 'Syntactic error in the TFT operation'
- 'Semantic errors in packet filter(s)'

- 'Syntactic errors in packet filters(s)'
- 'Mandatory IE incorrect'
- 'Mandatory IE missing'
- 'Optional IE incorrect'
- 'Invalid message format'
- 'Version not supported'

The Tunnel Endpoint Identifier Data I field specifies an uplink Tunnel Endpoint Identifier for G-PDUs that is chosen by the GGSN. The SGSN shall include this Tunnel Endpoint Identifier in the GTP header of all subsequent uplink G-PDUs that are related to the requested PDP context.

The Tunnel Endpoint Identifier Signalling field specifies an uplink Tunnel Endpoint Identifier for signalling messages, which is chosen by the GGSN. The SGSN shall include this Tunnel Endpoint Identifier in the GTP header of all subsequent uplink signalling messages, which are related to the requested PDP context. This field shall not be present if a signalling tunnel for the given MS between the peer GSNs already exists.

The QoS values supplied in the Update PDP Context Request may be negotiated downwards by the GGSN. The negotiated values or the original value from SGSN is inserted in the Quality of Service Profile information element. This information element shall be included if the Cause contains the value 'Request accepted'.

~~If a connection less (or an existing reliable connection oriented) path is to be used to tunnel T-PDUs for the given PDP context, the GGSN may start to forward T-PDUs after the Update PDP Context Response has been sent. The SGSN may start to forward T-PDUs when the Update PDP Context Response has been received. In this case the SGSN shall also be prepared to receive T-PDUs from the GGSN after it has sent an Update PDP Context Request but before an Update PDP Context Response has been received.~~

~~If a reliable connection oriented path is to be used to tunnel T-PDUs for the given PDP context and a connection does not exist between the GSN pair, the SGSN shall establish a connection and the GGSN shall wait for the connection before forwarding of T-PDUs may start.~~

~~Only one connection shall be used between any given GSN pair, and this connection shall be used to tunnel end user traffic in both directions.~~

The GGSN shall include a GGSN Address for signalling and an GGSN address for user traffic, which may differ from that provided by the underlying network service (e.g. IP). The SGSN shall store these GGSN Addresses and use them when sending subsequent signalling on this GTP tunnel or G-PDUs to the GGSN for the MS. When active contexts are being redistributed due to load sharing, G-PDUs that are in transit across the Gn-interface are in an undetermined state and may be lost.

The GGSN shall include the Recovery information element into the Update PDP Context Response if the GGSN is in contact with the SGSN for the first time or if the GGSN has restarted recently and the new Restart Counter value has not yet been indicated to the SGSN. The SGSN receiving the Recovery information element shall handle it as when an Echo Response message is received but shall consider the PDP context as updated and active if the response cause indicates a successful operation at the GGSN.

The Charging ID is used to identify all charging records produced in SGSN(s) and the GGSN for this PDP context. The Charging ID has been previously generated by the GGSN and is unique for this PDP context. If an inter-SGSN routing area update occurs, it is transferred to the new SGSN as part of each active PDP context.

The Charging Gateway Address is the IP address of the recommended Charging Gateway Functionality to which the SGSN should transfer the Charging Detail Records (CDR) for this PDP Context.

The optional Private Extension contains vendor or operator specific information.

***** NEXT CHANGE *****

7.5.5 SGSN Context Acknowledge

The new SGSN shall send an SGSN Context Acknowledge message to the old SGSN as a response to the SGSN Context Response message. Only after receiving the SGSN Context Acknowledge message, shall the old SGSN start to forward user data packets. SGSN Context Acknowledge indicates to the old SGSN that the new SGSN has correctly

received PDP Context information and is ready to receive user data packets identified by the corresponding Tunnel Endpoint Identifier values.

Possible cause values are:

- 'Request accepted'
- 'System failure'
- 'Mandatory IE incorrect'
- 'Mandatory IE missing'
- 'Optional IE incorrect'
- 'No resources available'
- 'Invalid message format'
- 'Version not supported'
- 'Authentication failure'.

Only the Cause information element shall be included in the acknowledgement if the Cause contains a value other than 'Request accepted'.

For each active PDP context the new SGSN shall include a Tunnel Endpoint Identifier Data II information element. The Tunnel Endpoint Identifier Data II field specifies a Tunnel Endpoint Identifier which is chosen by the new SGSN for a particular PDP context. The old SGSN shall include this Tunnel Endpoint Identifier I in the GTP header of all subsequent G-PDUs which are sent from the old SGSN to the new SGSN and related to the particular PDP context.

~~If any of the PDP contexts has a QoS reliability class which indicates that a reliable connection-oriented path should be used to forward T-PDUs coming via the old route and no connection has already been established, the old SGSN shall set up a connection to the new SGSN after receiving SGSN-Context-Acknowledge message.~~

The new SGSN shall include an SGSN Address for user traffic, which may differ from that provided by the underlying network service (e.g. IP). The old SGSN shall store this SGSN Address and use it when sending G-PDUs to the new SGSN for the MS.

The optional Private Extension contains vendor or operator specific information.

CHANGE REQUEST		Please see embedded help file at the bottom of this page for instructions on how to fill in this form correctly.	
29.060 CR 108		Current Version: 3.4.0	
GSM (AA.BB) or 3G (AA.BBB) specification number ↑		↑ CR number as allocated by MCC support team	
For submission to: CN#08 <small>list expected approval meeting # here ↑</small>	for approval <input checked="" type="checkbox"/> for information <input type="checkbox"/>	strategic <input type="checkbox"/> non-strategic <input checked="" type="checkbox"/>	(for SMG use only)

Form: CR cover sheet, version 2 for 3GPP and SMG The latest version of this form is available from: <ftp://ftp.3gpp.org/Information/CR-Form-v2.doc>

Proposed change affects: (U)SIM ME UTRAN / Radio Core Network
(at least one should be marked with an X)

Source: **N4** **Date:** _____

Subject: On the use of the Sequence number in GTP-C

Work item: GTP Enhancements

Category:	F Correction <input checked="" type="checkbox"/>	Release:	Phase 2 <input type="checkbox"/>
(only one category shall be marked with an X)	A Corresponds to a correction in an earlier release <input type="checkbox"/>		Release 96 <input type="checkbox"/>
	B Addition of feature <input type="checkbox"/>		Release 97 <input type="checkbox"/>
	C Functional modification of feature <input type="checkbox"/>		Release 98 <input type="checkbox"/>
	D Editorial modification <input type="checkbox"/>		Release 99 <input checked="" type="checkbox"/>
			Release 00 <input type="checkbox"/>

Reason for change: Section "Reliable delivery of signaling messages" specifies the following:

"Each path maintains a queue with signalling messages to be sent to the peer. The message at the front of the queue shall be sent with a Sequence Number, and shall be held in a path list until a response is received. Each path has its own list. The Sequence Number shall be unique for each outstanding message in a single path list. A GSN may have several outstanding requests while waiting for responses."

This is in contradiction with the use of the Sequence number as specified in section 8.2, where it is possible to use the sequence number on a per tunnel basis. This would make impossible guaranteeing that "The Sequence Number shall be unique for each outstanding message in a single path list", since different signaling tunnels may use different sequences over the same path.

This CR solves this problem.

Clauses affected: **8.2**

Other specs affected:	Other 3G core specifications <input type="checkbox"/>	→ List of CRs:	_____
	Other GSM core specifications <input type="checkbox"/>	→ List of CRs:	_____
	MS test specifications <input type="checkbox"/>	→ List of CRs:	_____
	BSS test specifications <input type="checkbox"/>	→ List of CRs:	_____
	O&M specifications <input type="checkbox"/>	→ List of CRs:	_____

Other comments: _____



help.doc

<----- double-click here for help and instructions on how to create a CR.

8.2 Usage of the GTP-C Header

For signalling messages the GTP header shall be used as follows:

- Version shall be set to decimal 1 ('001').
- Protocol Type (PT) shall be set to '1'.
- (S) shall be set to '1'.
- PN shall be set to '0'.
- Message Type shall be set to the unique value that is used for each type of signalling message. Valid message types are marked with a x in the GTP-C column in Table 1.
- Length shall be the length, in octets, of the signalling message excluding the GTP header.
- The Tunnel Endpoint Identifier is set by the sending entity to the value requested by the corresponding entity (SGSN or GGSN) and points out the MS and its associated context data, except for the following cases:
 - The first Create PDP Context Request message for a given MS sent to a specific GGSN shall have the Tunnel Endpoint Identifier set to all zeros, since this will be the message that establishes the tunnel in the signalling plane for this specific MS. One exception is the Network Initiated PDP context activation procedure, where the TEID in the Create PDP Context Request shall be set to the TEID requested in the PDU Notification Request.
 - The Identification Request/Response messages where the Tunnel Endpoint Identifier shall be set to all zeros.
 - The SGSN Context Request message where the Tunnel Endpoint Identifier shall be set to all zeros.
 - The Echo Request/Response and Version Not Supported messages where the Tunnel Endpoint Identifier shall be set to all zeros.
 - The Forward Relocation Request message where the Tunnel Endpoint Identifier shall be set to all zeros.
 - The PDU Notification Request message where the Tunnel Endpoint Identifier shall be set to all zeros, except for the case where a signalling tunnel is already established for that specific MS.
 - All Location Management messages where the Tunnel Endpoint Identifier shall be set to all zeros.
- Sequence Number shall be a message number valid for a path ~~or a tunnel~~. Within a given set of contiguous Sequence Numbers from 0 to 65535, a given Sequence Number shall, if used, unambiguously define a GTP signalling request message sent on the path ~~or tunnel~~ (see section Reliable delivery of signalling messages). The Sequence Number in a signalling response message shall be copied from the signalling request message that the GSN is replying to.
- N-PDU Number shall not be present.

CHANGE REQUEST

Please see embedded help file at the bottom of this page for instructions on how to fill in this form correctly.

29.060 CR 109

Current Version: **3.4.0**

GSM (AA.BB) or 3G (AA.BBB) specification number ↑

↑ CR number as allocated by MCC support team

For submission to: **CN#08**
list expected approval meeting # here ↑

for approval
for information

strategic
non-strategic (for SMG use only)

Form: CR cover sheet, version 2 for 3GPP and SMG The latest version of this form is available from: <ftp://ftp.3gpp.org/Information/CR-Form-v2.doc>

Proposed change affects:
(at least one should be marked with an X)

(U)SIM ME UTRAN / Radio Core Network

Source: **N4** **Date:**

Subject: **N-PDU number in GTP-C**

Work item: **GTP Enhancements**

Category:
(only one category shall be marked with an X)

F Correction	<input checked="" type="checkbox"/>	Release: Phase 2	<input type="checkbox"/>
A Corresponds to a correction in an earlier release	<input type="checkbox"/>	Release 96	<input type="checkbox"/>
B Addition of feature	<input type="checkbox"/>	Release 97	<input type="checkbox"/>
C Functional modification of feature	<input type="checkbox"/>	Release 98	<input type="checkbox"/>
D Editorial modification	<input type="checkbox"/>	Release 99	<input checked="" type="checkbox"/>
		Release 00	<input type="checkbox"/>

Reason for change:
Section 8.2 on GTP-C header usage specifies that the "N-PDU number shall not be present"
Reality is that such a field Shall be present, but Shall not be interpreted.
This CR solves this problem.

Clauses affected: **8.2**

Other specs affected:

Other 3G core specifications	<input type="checkbox"/>	→ List of CRs:	
Other GSM core specifications	<input type="checkbox"/>	→ List of CRs:	
MS test specifications	<input type="checkbox"/>	→ List of CRs:	
BSS test specifications	<input type="checkbox"/>	→ List of CRs:	
O&M specifications	<input type="checkbox"/>	→ List of CRs:	

Other comments:



<----- double-click here for help and instructions on how to create a CR.

8.2 Usage of the GTP-C Header

For signalling messages the GTP header shall be used as follows:

- Version shall be set to decimal 1 ('001').
- Protocol Type (PT) shall be set to '1'.
- (S) shall be set to '1'.
- PN shall be set to '0'.
- Message Type shall be set to the unique value that is used for each type of signalling message. Valid message types are marked with a x in the GTP-C column in Table 1.
- Length shall be the length, in octets, of the signalling message excluding the GTP header.
- The Tunnel Endpoint Identifier is set by the sending entity to the value requested by the corresponding entity (SGSN or GGSN) and points out the MS and its associated context data, except for the following cases:
 - The first Create PDP Context Request message for a given MS sent to a specific GGSN shall have the Tunnel Endpoint Identifier set to all zeros, since this will be the message that establishes the tunnel in the signalling plane for this specific MS. One exception is the Network Initiated PDP context activation procedure, where the TEID in the Create PDP Context Request shall be set to the TEID requested in the PDU Notification Request.
 - The Identification Request/Response messages where the Tunnel Endpoint Identifier shall be set to all zeros.
 - The SGSN Context Request message where the Tunnel Endpoint Identifier shall be set to all zeros.
 - The Echo Request/Response and Version Not Supported messages where the Tunnel Endpoint Identifier shall be set to all zeros.
 - The Forward Relocation Request message where the Tunnel Endpoint Identifier shall be set to all zeros.
 - The PDU Notification Request message where the Tunnel Endpoint Identifier shall be set to all zeros, except for the case where a signalling tunnel is already established for that specific MS.
 - All Location Management messages where the Tunnel Endpoint Identifier shall be set to all zeros.
- Sequence Number shall be a message number valid for a path or a tunnel. Within a given set of contiguous Sequence Numbers from 0 to 65535, a given Sequence Number shall, if used, unambiguously define a GTP signalling request message sent on the path or tunnel (see section Reliable delivery of signalling messages). The Sequence Number in a signalling response message shall be copied from the signalling request message that the GSN is replying to.
- N-PDU Number shall not be ~~present~~interpreted.

CHANGE REQUEST			Please see embedded help file at the bottom of this page for instructions on how to fill in this form correctly.
29.060	CR	112	Current Version: 3.4.0
GSM (AA.BB) or 3G (AA.BBB) specification number ↑		↑ CR number as allocated by MCC support team	
For submission to: CN#08	for approval	<input checked="" type="checkbox"/>	strategic <input type="checkbox"/>
list expected approval meeting # here ↑	for information	<input type="checkbox"/>	non-strategic <input checked="" type="checkbox"/> <small>(for SMG use only)</small>

Form: CR cover sheet, version 2 for 3GPP and SMG The latest version of this form is available from: <ftp://ftp.3gpp.org/Information/CR-Form-v2.doc>

Proposed change affects: (U)SIM ME UTRAN / Radio Core Network
(at least one should be marked with an X)

Source: N4 **Date:** 16th May 2000

Subject: Introducing Supported Extension Headers Notification to GTP-U

Work item: GTP Enhancements

Category:	F Correction <input checked="" type="checkbox"/>	Release:	Phase 2 <input type="checkbox"/>
(only one category shall be marked with an X)	A Corresponds to a correction in an earlier release <input type="checkbox"/>		Release 96 <input type="checkbox"/>
	B Addition of feature <input type="checkbox"/>		Release 97 <input type="checkbox"/>
	C Functional modification of feature <input type="checkbox"/>		Release 98 <input type="checkbox"/>
	D Editorial modification <input type="checkbox"/>		Release 99 <input checked="" type="checkbox"/>
			Release 00 <input type="checkbox"/>

Reason for change: Extension headers can also be used in GTP-U. This CR proposes to include Supported Extension Headers Notification message also to GTP-U.

Furthermore, Supported Extension Headers Notification message is proposed to be moved under Path Management messages from Tunnel Management messages, since the scope of this message is Path Management.

Clauses affected: 7.1, 7.3.12 moved to 7.2.4

Other specs affected:	Other 3G core specifications <input type="checkbox"/>	→ List of CRs:	
	Other GSM core specifications <input type="checkbox"/>	→ List of CRs:	
	MS test specifications <input type="checkbox"/>	→ List of CRs:	
	BSS test specifications <input type="checkbox"/>	→ List of CRs:	
	O&M specifications <input type="checkbox"/>	→ List of CRs:	

Other comments:



help.doc

<----- double-click here for help and instructions on how to create a CR.

7 GTP Messages and Message Formats

7.1 Signalling Message Formats

GTP defines a set of signalling messages between two associated GSNs or an SGSN and an RNC. The signalling messages to be used are defined in the table below. The three columns to the right define which parts (GTP-C, GTP-U or GTP*) that send or receive the specific message type.

Table 1: Signalling messages in GTP

Message Type value (Decimal)	Signalling message	Reference	GTP-C	GTP-U	GTP'
0	For future use. Shall not be sent. If received, shall be treated as an Unknown message.				
1	Echo Request	7.2.1	X	X	
2	Echo Response	7.2.2	X	X	
3	Version Not Supported	7.2.3	X	X	
4	Node Alive Request	GSM 12.15			X
5	Node Alive Response	GSM 12.15			X
6	Redirection Request	GSM 12.15			X
7	Redirection Response	GSM 12.15			X
8-15	For future use. Shall not be sent. If received, shall be treated as an Unknown message.				
16	Create PDP Context Request	7.3.1	X		
17	Create PDP Context Response	7.3.2	X		
18	Update PDP Context Request	7.3.3	X		
19	Update PDP Context Response	7.3.4	X		
20	Delete PDP Context Request	7.3.5	X		
21	Delete PDP Context Response	7.3.6	X		
22-25	For future use. Shall not be sent. If received, shall be treated as an Unknown message.				
26	Error Indication	7.3.7	X		
27	PDU Notification Request	7.3.8	X		
28	PDU Notification Response	7.3.9	X		
29	PDU Notification Reject Request	7.3.10	X		
30	PDU Notification Reject Response	7.3.11	X		
31	Supported Extension Headers Notification	7.3.12 7.2.4	X	X	
32	Send Routing Information for GPRS Request	7.4.1	X		
33	Send Routing Information for GPRS Response	7.4.2	X		
34	Failure Report Request	7.4.3	X		
35	Failure Report Response	7.4.4	X		
36	Note MS GPRS Present Request	7.4.5	X		
37	Note MS GPRS Present Response	7.4.6	X		
38-47	For future use. Shall not be sent. If received, shall be treated as an Unknown message.				
48	Identification Request	7.5.1	X		
49	Identification Response	7.5.2	X		
50	SGSN Context Request	7.5.3	X		
51	SGSN Context Response	7.5.4	X		
52	SGSN Context Acknowledge	7.5.5	X		
53	Forward Relocation Request	7.5.6	X		
54	Forward Relocation Response	7.5.7	X		
55	Forward Relocation Complete	7.5.8	X		
56	Relocation Cancel Request	7.5.9	X		
57	Relocation Cancel Response	7.5.10	X		
58	Forward SRNS Context	7.5.11	X		
59-239	For future use. Shall not be sent. If received, shall be treated as an Unknown message.				
240	Data Record Transfer Request	GSM 12.15			X
241	Data Record Transfer Response	GSM 12.15			X
242-254	For future use. Shall not be sent. If received, shall be treated as an Unknown message.				
255	T-PDU	9.3.1		X	

7.2 Path Management Messages

The Path Management messages may be sent between any type of GSN or GSN - RNC pair.

7.2.1 Echo Request

An Echo Request may be sent on a path to another GSN or RNC to find out if the peer GSN or RNC is alive (see section Path Failure). Echo Request messages may be sent for each path in use. A path is considered to be in use if at least one PDP context uses the path to the other GSN. When and how often an Echo Request message may be sent is implementation specific but an Echo Request shall not be sent more often than every 60 seconds on each path.

A GSN or RNC shall be prepared to receive an Echo Request at any time and it shall reply with an Echo Response. A GSN or RNC may optionally send Echo Request messages.

The optional Private Extension contains vendor or operator specific information.

Table 2: Information Elements in an Echo Request

Information element	Presence requirement	Reference
Private Extension	Optional	7.7.44

7.2.2 Echo Response

The message shall be sent as a response of a received Echo Request.

The Recovery information element contains the local Restart Counter (see section Restoration and Recovery) value for the GSN or RNC that sends the Echo Response message.

The GSN or RNC that receives an Echo Response from a peer GSN or RNC shall compare the Restart Counter value received with the previous Restart Counter value stored for that peer GSN. If no previous value was stored, the Restart Counter value received in the Echo Response shall be stored for the peer GSN or RNC.

The value of a Restart Counter previously stored for a peer GSN or RNC may differ from the Restart Counter value received in the Echo Response from that peer GSN or RNC. In this case, the GSN or RNC that sent the Echo Response shall be considered as restarted by the GSN that received the Echo Response. The new Restart Counter value received shall be stored by the receiving entity, replacing the value previously stored for the sending GSN or RNC. If the sending GSN is a GGSN and the receiving GSN is a SGSN, the SGSN shall notify an affected MS next time the MS contacts the SGSN. An affected MS is an MS that has at least one activated PDP context that was using the restarted GGSN. The SGSN shall consider all PDP contexts using the path as inactive.

The optional Private Extension contains vendor or operator specific information.

Table 3: Information Elements in an Echo Response

Information element	Presence requirement	Reference
Recovery	Mandatory	7.7.11
Private Extension	Optional	7.7.44

7.2.3 Version Not Supported

This message contains only the GTP header and indicates the latest GTP version that the GTP entity on the identified UDP/IP address can support.

7.3.127.2.4 Supported Extension Headers Notification

This message indicates a list of supported Extension Headers that the GTP entity on the identified IP address can support. This message is sent only in case a GTP entity was required to interpret a mandatory Extension Header but the GSN or RNC was not yet upgraded to support that extension header. The GTP endpoint at the GSN or RNC sending this message is marked as not enabled to support some extension headers (as derived from the supported extension header list). The GSN may retry to use all the extension headers with that node, in an attempt to verify it has been upgraded. Implementers should avoid repeated attempts to use unknown extension headers with an endpoint that has signalled its inability to interpret them.

Table 17: Information Elements in Supported Extension Headers Notification

Information element	Presence requirement	Reference
Extension Header Type List	Mandatory	7.7.40

CHANGE REQUEST				Please see embedded help file at the bottom of this page for instructions on how to fill in this form correctly.	
29.060		CR 113		Current Version: 3.4.0	
GSM (AA.BB) or 3G (AA.BBB) specification number ↑		↑ CR number as allocated by MCC support team			
For submission to: CN#08		for approval X		strategic <input type="checkbox"/>	
list expected approval meeting # here ↑		for information <input type="checkbox"/>		non-strategic X (for SMG use only)	

Form: CR cover sheet, version 2 for 3GPP and SMG The latest version of this form is available from: <ftp://ftp.3gpp.org/Information/CR-Form-v2.doc>

Proposed change affects: (U)SIM ME UTRAN / Radio Core Network **X**
(at least one should be marked with an X)

Source: N4 **Date:** 2000-05-16

Subject: Missing IEs in Error Indication

Work item: GTP Enhancements

Category:	F Correction <input checked="" type="checkbox"/> A Corresponds to a correction in an earlier release <input type="checkbox"/> B Addition of feature <input type="checkbox"/> C Functional modification of feature <input type="checkbox"/> D Editorial modification <input type="checkbox"/>		Release:	Phase 2 <input type="checkbox"/> Release 96 <input type="checkbox"/> Release 97 <input type="checkbox"/> Release 98 <input type="checkbox"/> Release 99 <input checked="" type="checkbox"/> Release 00 <input type="checkbox"/>
------------------	--	--	-----------------	--

(only one category shall be marked with an X)

Reason for change: Since the Error Indication is a GTP-C message, it should use an established GTP-C tunnel if possible. If no GTP-C tunnel exists for that particular MS, the 'default' GTP-C tunnel (with TEID filled with zeros) shall be used.

In order for the receiving GSN to be able to act on the incoming Error Indication, it needs information about the TEID and GSN address of the G-PDU that triggered the procedure. These two IEs are added to the Error Indication.

Clauses affected: 7.3.7 and 8.2

Other specs affected:	Other 3G core specifications <input type="checkbox"/> Other GSM core specifications <input type="checkbox"/> MS test specifications <input type="checkbox"/> BSS test specifications <input type="checkbox"/> O&M specifications <input type="checkbox"/>	→ List of CRs: → List of CRs: → List of CRs: → List of CRs: → List of CRs:	
------------------------------	---	--	--

Other comments:



<----- double-click here for help and instructions on how to create a CR.

7.3.7 Error Indication

The SGSN may send an Error Indication to the GGSN if no PDP context exists or the PDP context is inactive for a received G-PDU. The SGSN shall also send an Error Indication to the GGSN if no MM context exists for a received G-PDU.

At the Inter SGSN Routing Area Update and the Inter SRNS Relocation procedures the new SGSN sends an Error Indication to the old SGSN if no active PDP context exists for a received G-PDU.

The GGSN may send an Error Indication to the SGSN if no PDP context exists for a received G-PDU.

The GGSN shall delete its PDP context and may notify the Operation and Maintenance network element when an Error Indication is received.

The SGSN shall indicate to the MS when a PDP context has been deleted due to the reception of an Error Indication message. The MS may then request the re-establishment of the PDP context.

The old SGSN shall delete its PDP context and may notify the Operation and Maintenance network element when an Error Indication is received.

The information elements Tunnel Endpoint Identifier Data I and GSN address shall be the TEID and GSN address respectively, fetched from the G-PDU that triggered this procedure.

~~The Tunnel Endpoint Identifier used in the Error Indication message shall be fetched from the G-PDU that triggered this procedure.~~

The optional Private Extension contains vendor or operator specific information.

Table 12: Information Elements in an Error Indication

Information element	Presence requirement	Reference
Tunnel Endpoint Identifier Data I	Mandatory	7.7.13
GSN Address	Mandatory	7.7.32
Private Extension	Optional	7.7.44

***** Next change *****

8.2 Usage of the GTP-C Header

For signalling messages the GTP header shall be used as follows:

- Version shall be set to decimal 1 ('001').
- Protocol Type (PT) shall be set to '1'.
- (S) shall be set to '1'.
- PN shall be set to '0'.
- Message Type shall be set to the unique value that is used for each type of signalling message. Valid message types are marked with a x in the GTP-C column in Table 1.
- Length shall be the length, in octets, of the signalling message excluding the GTP header.
- The Tunnel Endpoint Identifier is set by the sending entity to the value requested by the corresponding entity (SGSN or GGSN) and points out the MS and its associated context data, except for the following cases:
 - The first Create PDP Context Request message for a given MS sent to a specific GGSN shall have the Tunnel Endpoint Identifier set to all zeros, since this will be the message that establishes the tunnel in the signalling plane for this specific MS. One exception is the Network Initiated PDP context activation procedure, where the TEID in the Create PDP Context Request shall be set to the TEID requested in the PDU Notification Request.

- The Identification Request/Response messages where the Tunnel Endpoint Identifier shall be set to all zeros.
- The SGSN Context Request message where the Tunnel Endpoint Identifier shall be set to all zeros.
- The Echo Request/Response and Version Not Supported messages where the Tunnel Endpoint Identifier shall be set to all zeros.
- The Forward Relocation Request message where the Tunnel Endpoint Identifier shall be set to all zeros.
- The PDU Notification Request message where the Tunnel Endpoint Identifier shall be set to all zeros, except for the case where a signalling tunnel is already established for that specific MS.
- The Error Indication message where the Tunnel Endpoint Identifier shall be set to all zeros, in case there is no signalling tunnel established for that specific MS.
- All Location Management messages where the Tunnel Endpoint Identifier shall be set to all zeros.
 - Sequence Number shall be a message number valid for a path or a tunnel. Within a given set of contiguous Sequence Numbers from 0 to 65535, a given Sequence Number shall, if used, unambiguously define a GTP signalling request message sent on the path or tunnel (see section Reliable delivery of signalling messages). The Sequence Number in a signalling response message shall be copied from the signalling request message that the GSN is replying to.
 - N-PDU Number shall not be present.

The GTP header may be followed by subsequent information elements dependent on the type of signalling message. Only one information element of each type is allowed in a single signalling message, except for the Authentication Triplet, the PDP Context and the Tunnel Endpoint Identifier Data II information element where several occurrences of each type are allowed.

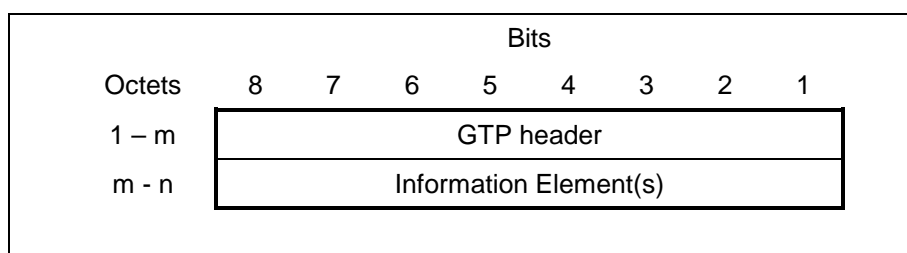

Figure 59: GTP Header followed by subsequent Information Elements

CHANGE REQUEST

Please see embedded help file at the bottom of this page for instructions on how to fill in this form correctly.

29.060 CR 114

Current Version: **3.4.0**

GSM (AA.BB) or 3G (AA.BBB) specification number ↑

↑ CR number as allocated by MCC support team

For submission to: **CN#08**
 list expected approval meeting # here ↑

for approval
 for information

strategic
 non-strategic (for SMG use only)

Form: CR cover sheet, version 2 for 3GPP and SMG The latest version of this form is available from: <ftp://ftp.3gpp.org/Information/CR-Form-v2.doc>

Proposed change affects: (U)SIM ME UTRAN / Radio Core Network
 (at least one should be marked with an X)

Source: **N4** **Date:** **16/May/2000**

Subject: Clarification of the Cause of Create PDP Context Response

Work item: GTP enhancements

Category: <small>(only one category shall be marked with an X)</small>	F Correction	<input checked="" type="checkbox"/>	Release:	Phase 2	<input type="checkbox"/>
	A Corresponds to a correction in an earlier release	<input type="checkbox"/>		Release 96	<input type="checkbox"/>
	B Addition of feature	<input type="checkbox"/>		Release 97	<input type="checkbox"/>
	C Functional modification of feature	<input type="checkbox"/>		Release 98	<input type="checkbox"/>
	D Editorial modification	<input type="checkbox"/>		Release 99	<input checked="" type="checkbox"/>
			Release 00	<input type="checkbox"/>	

Reason for change: The cause 'Service not supported' in Create PDP Context Response can't be mapped to the cause in Activate PDP Context Reject defined in 24.008. Because 'Missing or unknown APN' and 'Unknown PDP address or PDP type' is defined separately in 24.008. Then the SGSN can't decide which cause code should be mapped to the cause in Activate PSP Context Reject.
 This CR proposes to remove 'Service not supported' and add 'Missing or unknown APN' and 'Unknown PDP address or PDP type' in the cause list of Create PDP Context Response.

Clauses affected: 7.3.2, 7.7.1

Other specs affected:	Other 3G core specifications	<input type="checkbox"/>	→ List of CRs:	
	Other GSM core specifications	<input type="checkbox"/>	→ List of CRs:	
	MS test specifications	<input type="checkbox"/>	→ List of CRs:	
	BSS test specifications	<input type="checkbox"/>	→ List of CRs:	
	O&M specifications	<input type="checkbox"/>	→ List of CRs:	

Other comments:



help.doc

<----- double-click here for help and instructions on how to create a CR.

7.3.2 Create PDP Context Response

The message shall be sent from a GGSN node to a SGSN node as a response of a Create PDP Context Request. When the SGSN receives a Create PDP Context Response with the Cause value indicating 'Request Accepted', the SGSN activates the PDP context and may start to forward T-PDUs to/from the MS from/to the external data network.

The Cause value indicates if a PDP context has been created in the GGSN or not. A PDP context has not been created in the GGSN if the Cause differs from 'Request accepted'. Possible Cause values are:

- "Request Accepted".
- "No resources available".
- "All dynamic PDP addresses are occupied".
- "No memory is available".
- ~~"Service not supported".~~
- "Missing or unknown APN".
- "Unknown PDP address or PDP type".
- "User authentication failed".
- "System failure".
- "Semantic error in the TFT operation".
- "Syntactic error in the TFT operation".
- "Semantic errors in packet filter(s)".
- "Syntactic errors in packet filters(s)".
- "Mandatory IE incorrect".
- "Mandatory IE missing".
- "Optional IE incorrect".
- "Invalid message format".
- "Version not supported".

'No resources available' indicates e.g. that all dynamic PDP addresses are occupied or no memory is available. "Missing or unknown APN" indicates e.g. when the GGSN does not support the "Missing or unknown APN" Access Point Name. "Unknown PDP address or PDP type" indicates e.g. when the GGSN does not support the "Unknown PDP address or PDP type" PDP type or the PDP address.

'User authentication failed' indicates that the external packet network has rejected the service requested by the user.

Only the Cause information element, optionally Protocol Configuration Options and optionally the Recovery information element shall be included in the response if the Cause contains another value than 'Request accepted'.

All information elements, except Recovery, Protocol Configuration Options, and Private Extension, are mandatory if the Cause contains the value 'Request accepted'.

The Tunnel Endpoint Identifier Data I field specifies an uplink Tunnel Endpoint Identifier for G-PDUs that is chosen by the GGSN. The SGSN shall include this Tunnel Endpoint Identifier in the GTP header of all subsequent uplink G-PDUs which are related to the requested PDP context.

The Tunnel Endpoint Identifier Signalling field specifies an uplink Tunnel Endpoint Identifier for signalling messages, which is chosen by the GGSN. The SGSN shall include this Tunnel Endpoint Identifier in the GTP header of all subsequent uplink-signalling messages, which are related to the requested PDP context. This field shall not be present if a signalling tunnel already exists for the given MS between the peer GSNs.

The GGSN shall include a GGSN Address for signalling and a GGSN address for user traffic, which may differ from that provided by the underlying network service (e.g. IP). The SGSN shall store these GGSN Addresses and use them when sending signalling on this GTP tunnel or G-PDUs to the GGSN for the MS.

If the MS requests a dynamic PDP address and a dynamic PDP address is allowed, then the End User Address information element shall be included and the PDP Address field in the End User Address information element shall contain the dynamic PDP Address allocated by the GGSN. In case the PDP addresses carried in the End User Address and optionally in the Protocol Configuration Option information element contain contradicting information, the PDP address carried in the End User Address information element takes the higher precedence.

The QoS values supplied in the Create PDP Context Request may be negotiated downwards by the GGSN. The negotiated values or the original values from SGSN are inserted in the Quality of Service Profile information element of the Create PDP Context Response message.

If a connection-less (or an already existing reliable connection-oriented) path is to be used to tunnel T-PDUs for the given PDP context, the GGSN may start to forward T-PDUs after the Create PDP Context Response has been sent. The SGSN may start to forward T-PDUs when the Create PDP Context Response has been received. In this case the SGSN shall also be prepared to receive T-PDUs from the GGSN after it has sent a Create PDP Context Request but before a Create PDP Context Response has been received.

If a reliable connection-oriented path is to be used to tunnel T-PDUs for the given PDP context and a connection does not exist between the GSN pair, the SGSN shall establish a connection and the GGSN shall wait for the connection before forwarding of T-PDUs may start.

Only one connection shall be used between any given GSN-pair, and this connection shall be used to tunnel end user traffic in both directions.

The Reordering Required value supplied in the Create PDP Context Response indicates whether the end user protocol benefits from packet in sequence delivery and whether the SGSN and the GGSN therefore shall perform reordering or not. In other words, if reordering is required by the GGSN, the SGSN and the GGSN shall perform reordering of incoming T-PDUs on this path. When the Quality of Service (QoS) Profile is Release 99 the receiving entity shall ignore the Reordering Required.

The GGSN shall include the Recovery information element into the Create PDP Context Response if the GGSN is in contact with the SGSN for the first time or the GGSN has restarted recently and the new Restart Counter value has not yet been indicated to the SGSN. The SGSN receiving the Recovery information element shall handle it as when an Echo Response message is received but shall consider the PDP context being created as active if the response indicates successful context activation at the GGSN.

The Charging ID is used to identify all charging records produced in SGSN(s) and the GGSN for this PDP context. The Charging ID is generated by the GGSN and shall be unique within the GGSN.

The Charging Gateway Address is the IP address of the recommended Charging Gateway Functionality to which the SGSN should transfer the Charging Detail Records (CDR) for this PDP Context.

The optional Private Extension contains vendor or operator specific information.

Table 5: Information Elements in a Create PDP Context Response

Information element	Presence requirement	Reference
Cause	Mandatory	7.7.1
Reordering required	Conditional	7.7.6
Recovery	Optional	7.7.11
Tunnel Endpoint Identifier Data I	Conditional	7.7.13
Tunnel Endpoint Identifier Signalling	Conditional	7.7.14
Charging ID	Conditional	7.7.26
End User Address	Conditional	7.7.27
Protocol Configuration Options	Optional	7.7.31
GGSN Address for signalling	Conditional	GSN Address 7.7.32
GGSN Address for user traffic	Conditional	GSN Address 7.7.32
Quality of Service Profile	Conditional	7.7.34
Charging Gateway Address	Optional	7.7.43
Private Extension	Optional	7.7.44

***** Next Modification *****

7.7.1 Cause

In a request, the Cause Value indicates the reason for the request. The Cause shall be included in the request message.

In a response, the Cause Value indicates the acceptance or the rejection of the corresponding request. In addition, the Cause Value may indicate what was the reason for the corresponding request. The Cause value shall be included in the response message.

'Request accepted' is returned when a GSN has accepted a signalling request.

'Non-existent' indicates a non-existent or an inactive PDP context.

'IMSI not known' indicates a non-existent MM context.

'MS is GPRS Detached' indicates an idle MM context.

'MS is not GPRS Responding' and 'MS Refuses' may be used by SGSN to reject a Network-Requested PDP Context Activation.

'Version not supported' is returned when the recipient does not recognise the version number in the request message.

'Request IMSI', 'Request IMEI', 'Request IMSI and IMEI' and 'No identity needed' are used by GGSN to notify SGSN what to do.

'No resources available' is a generic temporary error condition e.g. all dynamic PDP addresses occupied or no memory available.

'Service not supported' is a generic error indicated that the GSN do not support the requested service.

'User authentication failed' indicates that the external packet network has rejected the user's service request.

'System failure' is a generic permanent error condition.

'Roaming restriction' indicates that the SGSN cannot activate the requested PDP context because of the roaming restrictions.

'P-TMSI Signature mismatch' is returned if either:

- the P-TMSI Signature stored in the old SGSN does not match the value sent by the MS via the new SGSN
- or the MS does not provide the P-TMSI Signature to the new SGSN while the old SGSN has stored the P-TMSI Signature for that MS.

‘Semantic error in the TFT operation’, ‘Syntactic error in the TFT operation’, ‘Semantic errors in packet filter(s)’ and ‘Syntactic errors in packet filters(s) are indications of abnormal cases involving TFTs. The abnormal TFT cases and the use of the cause codes are defined in 3G TS 24.008.

‘Invalid message format’, ‘Mandatory IE incorrect’, ‘Mandatory IE missing’ and ‘Optional IE incorrect’ are indications of protocol errors described in the section Error handling.

‘GPRS connection suspended’ indicates that the GPRS activities of the mobile station are suspended.

‘Authentication failure’ indicates that the user authentication failed in the new SGSN.

‘Context not found’ indicates that the PDP Context referenced in an Active Secondary Context Request message was not found in the receiving GGSN.

‘Relocation failure’ indicates that the SRNS relocation failed in the new SGSN side.

‘Unknown mandatory extension header’ signals in a response message that the corresponding request included an extension header for which comprehension was required but unknown to the receiving end.

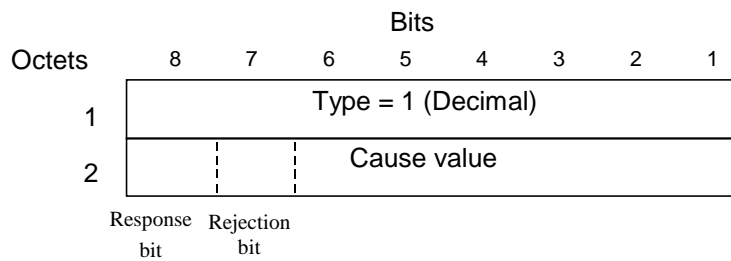

Figure 8: Cause information element

Table 36: Cause Values

Cause		Value (Decimal)	
request	Request IMSI	0	
	Request IMEI	1	
	Request IMSI and IMEI	2	
	No identity needed	3	
	MS Refuses	4	
	MS is not GPRS Responding	5	
	For future use	6-48	
Cause values reserved for GPRS charging protocol use (see GTP' in GSM 12.15)		49-63	
For future use		64-127	
response	acc	Request accepted	128
		For future use	129-176
		Cause values reserved for GPRS charging protocol use (see GTP' in GSM 12.15)	177-191
	rej	Non-existent	192
		Invalid message format	193
		IMSI not known	194
		MS is GPRS Detached	195
		MS is not GPRS Responding	196
		MS Refuses	197
		Version not supported	198
		No resources available	199
		Service not supported	200
		Mandatory IE incorrect	201
		Mandatory IE missing	202
		Optional IE incorrect	203
		System failure	204
		Roaming restriction	205
		P-TMSI Signature mismatch	206
		GPRS connection suspended	207
		Authentication failure	208
		User authentication failed	209
		Context not found	210
		All dynamic PDP addresses are occupied	211
		No memory is available	212
		Relocation failure	213
		Unknown mandatory extension header	214
		Semantic error in the TFT operation	215
		Syntactic error in the TFT operation	216
		Semantic errors in packet filter(s)	217
		Syntactic errors in packet filter(s)	218
		Missing or unknown APN	219
		Unknown PDP address or PDP type	220
		For future use	221-240
Cause values reserved for GPRS charging protocol use (see GTP' in GSM 12.15)		241-255	

NOTE: With this coding, bits 8 and 7 of the Cause Value respectively indicate whether the message was a request or a response, and whether the request was accepted or rejected.

Table 37: Use of the Cause Values

Cause 8	value bits 7	Result
0	0	Request
0	1	For future use (Note)
1	0	Acceptance
1	1	Rejection

NOTE: The value '01' is for future use and shall not be sent. If received in a response, it shall be treated as a rejection.

CHANGE REQUEST		Please see embedded help file at the bottom of this page for instructions on how to fill in this form correctly.	
29.060	CR	115	Current Version: 3.4.0
GSM (AA.BB) or 3G (AA.BBB) specification number ↑		↑ CR number as allocated by MCC support team	
For submission to: CN#08	for approval <input checked="" type="checkbox"/>	strategic <input type="checkbox"/>	(for SMG use only)
list expected approval meeting # here ↑	for information <input type="checkbox"/>	non-strategic <input checked="" type="checkbox"/>	

Form: CR cover sheet, version 2 for 3GPP and SMG The latest version of this form is available from: <ftp://ftp.3gpp.org/Information/CR-Form-v2.doc>

Proposed change affects: (U)SIM ME UTRAN / Radio Core Network
(at least one should be marked with an X)

Source: N4 **Date:** 2000-05-15

Subject: Clarification of the TEID for Signalling

Work item: GTP enhancements

Category:	F Correction <input checked="" type="checkbox"/> A Corresponds to a correction in an earlier release <input type="checkbox"/> B Addition of feature <input type="checkbox"/> C Functional modification of feature <input type="checkbox"/> D Editorial modification <input type="checkbox"/>	Release:	Phase 2 <input type="checkbox"/> Release 96 <input type="checkbox"/> Release 97 <input type="checkbox"/> Release 98 <input type="checkbox"/> Release 99 <input checked="" type="checkbox"/> Release 00 <input type="checkbox"/>
------------------	--	-----------------	--

(only one category shall be marked with an X)

Reason for change: The receiving side locally assigns the value of the TEID and sends to the transmitting side. The receiving side confirms TEID of the GTP header which the transmitting side sent.
 If the receiving side sends TEID which is different from the TEID sent before to the transmitting side, there are following problems:

- the transmitting side can't decide which TEID to set in GTP header.
- the receiving side can't know TEID to receive with the GTP header.

Therefore, the receiving side must not change TEID when TEID is sent toward the same transmitting side.
 This CR adds an explanation about the assignment of the TEID for Signalling.

Clauses affected: 7.7.14

Other specs affected:	Other 3G core specifications <input type="checkbox"/> Other GSM core specifications <input type="checkbox"/> MS test specifications <input type="checkbox"/> BSS test specifications <input type="checkbox"/> O&M specifications <input type="checkbox"/>	→ List of CRs: → List of CRs: → List of CRs: → List of CRs: → List of CRs:	
------------------------------	---	--	--

Other comments:



help.doc

<----- double-click here for help and instructions on how to create a CR.

7.7.14 Tunnel Endpoint Identifier Signalling

The Tunnel Endpoint Identifier Signalling information element contains the Tunnel Endpoint Identifier for signalling requested by the receiver of the flow.

If the receiver has already confirmed successful assignment of its Tunnel Endpoint Identifier for Signalling to the transmitter, this information element shall be the same as the value sent before. The receiver confirms successful assignment of its Tunnel Endpoint Identifier for Signalling to the transmitter when it receives any message with its assigned Tunnel Endpoint Identifier for Signalling in the GTP header from the transmitter.

If the transmitter received the Tunnel Endpoint Identifier for Signalling for the first time from the receiver, this information element shall be stored. If the transmitter has already received the Tunnel Endpoint Identifier for Signalling, this information shall be ignored.

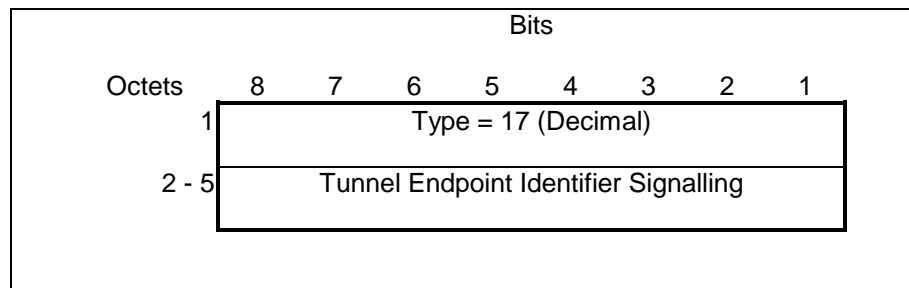

Figure 21: Tunnel Endpoint Identifier Signalling Information Element

CHANGE REQUEST

Please see embedded help file at the bottom of this page for instructions on how to fill in this form correctly.

29.060 CR 116

Current Version: **3.4.0**

GSM (AA.BB) or 3G (AA.BBB) specification number ↑

↑ CR number as allocated by MCC support team

For submission to: **CN#08**
list expected approval meeting # here ↑

for approval
for information

strategic
non-strategic (for SMG use only)

Form: CR cover sheet, version 2 for 3GPP and SMG The latest version of this form is available from: <ftp://ftp.3gpp.org/Information/CR-Form-v2.doc>

Proposed change affects:

(at least one should be marked with an X)

(U)SIM ME UTRAN / Radio Core Network

Source:

N4

Date:

2000-05-15

Subject:

Clarification on the TEID for Signalling of the PDU Notification Reject Request

Work item:

GTP enhancements

Category:

(only one category shall be marked with an X)

F Correction
A Corresponds to a correction in an earlier release
B Addition of feature
C Functional modification of feature
D Editorial modification

Release:

Phase 2
Release 96
Release 97
Release 98
Release 99
Release 00

Reason for change:

The clarification of the TEID for Signalling except for the PDU Notification Reject Request message was proposed by 29.060-CR093r2 (N4-000101) on the N4 meeting #1 in Charleston.
If the SGSN has already confirmed successful assignment of the TEID for Signalling to the peer GGSN, the SGSN doesn't need to include the TEID for Signalling in the PDU Notification Reject Request message.
Therefore, this CR proposes to change the presence requirement of the TEID for Signalling from 'Mandatory' to 'Conditional'.

Clauses affected:

7.3.10

Other specs affected:

Other 3G core specifications → List of CRs:
Other GSM core specifications → List of CRs:
MS test specifications → List of CRs:
BSS test specifications → List of CRs:
O&M specifications → List of CRs:

Other comments:

The **Tunnel Endpoint Identifier Signalling IE** were changed to the **Tunnel Endpoint Identifier for Signalling IE** on 29.060-CR093r2 (N4-000101) that agreed on N4 meeting #1 in Charleston.
And the explanation of the TEID in the GTP header of PDU Notification Reject Request message was clarified by 29.060-CR092r1 (N4-000070).



help.doc

<----- double-click here for help and instructions on how to create a CR.

7.3.10 PDU Notification Reject Request

If the PDP context activation proceeds after the PDU Notification Response, but the PDP context was not established, the SGSN sends a PDU Notification Reject Request message. The Cause value indicates the reason why the PDP Context could not be established:

- 'MS Not GPRS Responding'.
- 'MS Refuses'.

When receiving the PDU Notification Reject Request message the GGSN may reject or discard the stored T-PDU(s) depending on the PDP type.

After an unsuccessful activation attempt the GSNs may perform some actions to prevent unnecessary enquiries to the HLR as described in the section Unsuccessful Network-Requested PDP Context Activation procedure in 3G TS 23.060.

The Tunnel Endpoint Identifier in the GTP header of the PDU Notification Reject Request message shall be the same as the Tunnel Endpoint Identifier for Signalling information element of the PDU Notification Request that triggered the reject.

The Tunnel Endpoint Identifier for Signalling information element shall be a tunnel endpoint identifier signalling selected by the SGSN and shall be used by the GGSN in the GTP header of the corresponding PDU Notification Reject Response message. If the SGSN has already confirmed successful assignment of its Tunnel Endpoint Identifier for Signalling to the peer GGSN, this field shall not be present. The SGSN confirms successful assignment of its Tunnel Endpoint Identifier for Signalling to the GGSN when it receives any message with its assigned Tunnel Endpoint Identifier for Signalling in the GTP header from the GGSN.

The End User Address information element contains the PDP type and PDP address of the PDP context that could not be activated.

The optional Private Extension contains vendor or operator specific information.

Table 15: Information Elements in a PDU Notification Reject Request

Information element	Presence requirement	Reference
Cause	Mandatory	7.7.1
Tunnel Endpoint Identifier for Signalling	Conditional Mandatory	7.7.14
End User Address	Mandatory	7.7.27
Private Extension	Optional	7.7.44

<h2 style="margin: 0;">CHANGE REQUEST</h2>		Please see embedded help file at the bottom of this page for instructions on how to fill in this form correctly.
29.060	CR 117r2	Current Version: 3.4.0
GSM (AA.BB) or 3G (AA.BBB) specification number ↑	↑ CR number as allocated by MCC support team	
For submission to: CN#08 <small>list expected approval meeting # here ↑</small>	for approval <input checked="" type="checkbox"/> for information <input type="checkbox"/>	strategic <input type="checkbox"/> non-strategic <input checked="" type="checkbox"/> <small>(for SMG use only)</small>

Form: CR cover sheet, version 2 for 3GPP and SMG The latest version of this form is available from: <ftp://ftp.3gpp.org/Information/CR-Form-v2.doc>

Proposed change affects: (U)SIM ME UTRAN / Radio Core Network
(at least one should be marked with an X)

Source: **N4** **Date:** **2000-05-23**

Subject: Clarification of the conditional information elements

Work item: GTP enhancements

Category:	F Correction <input checked="" type="checkbox"/> A Corresponds to a correction in an earlier release <input type="checkbox"/> B Addition of feature <input type="checkbox"/> C Functional modification of feature <input type="checkbox"/> D Editorial modification <input type="checkbox"/>	Release:	Phase 2 <input type="checkbox"/> Release 96 <input type="checkbox"/> Release 97 <input type="checkbox"/> Release 98 <input type="checkbox"/> Release 99 <input checked="" type="checkbox"/> Release 00 <input type="checkbox"/>
------------------	--	-----------------	--

(only one category shall be marked with an X)

Reason for change: This CR proposes the addition of the explanation about the conditional information elements. Additional reasons are shown in the following.

- 1) If the SGSN is changed, the following information elements of the Update PDP Context Response are necessary. Because the new SGSN doesn't know them.
 - Tunnel Endpoint Identifier for Data I
 - Charging ID
 - GGSN Address for user traffic
- 2) If the SGSN Context Response contains the PDP context(s), the Tunnel Endpoint Identifier for Data II and the SGSN Address for user traffic information element in the SGSN Context Acknowledge is necessary. Because the old SGSN must send G-PDUs to address of the SGSN Address for user traffic.
- 3) The Tunnel Endpoint Identifier for Signalling information element in the Forward Relocation Response shall be included if the Cause contains the value 'Request accepted'.
- 4) If the Forward Relocation Request contains the PDP context(s), the RAB Setup Information in the Forward Relocation Response is necessary. Because the old SGSN must know the result of RAB setup in the new SGSN.

Clauses affected: **7.3.4, 7.5.5, 7.5.7**

Other specs affected:	Other 3G core specifications <input type="checkbox"/> Other GSM core specifications <input type="checkbox"/> MS test specifications <input type="checkbox"/> BSS test specifications <input type="checkbox"/> O&M specifications <input type="checkbox"/>	→ List of CRs: → List of CRs: → List of CRs: → List of CRs: → List of CRs:	
------------------------------	---	--	--

**Other
comments:**



help.doc

<----- double-click here for help and instructions on how to create a CR.

7.3.4 Update PDP Context Response

The message shall be sent from a GGSN node to a SGSN node as a response of an Update PDP Context Request.

If the SGSN receives an Update PDP Context Response with a Cause value other than 'Request accepted', it shall deactivate the PDP context.

Only the Cause information element and optionally the Recovery information element shall be included in the response if the Cause contains another value than 'Request accepted'.

Possible Cause values are:

- 'Request Accepted'.
- 'Non-existent'.
- 'Service not supported'.
- 'System failure'.
- 'Semantic error in the TFT operation'.
- 'Syntactic error in the TFT operation'.
- 'Semantic errors in packet filter(s)'.
- 'Syntactic errors in packet filters(s)'.
- 'Mandatory IE incorrect'.
- 'Mandatory IE missing'.
- 'Optional IE incorrect'.
- 'Invalid message format'.
- 'Version not supported'.

The Tunnel Endpoint Identifier Data I field specifies an uplink Tunnel Endpoint Identifier for G-PDUs that is chosen by the GGSN. The SGSN shall include this Tunnel Endpoint Identifier in the GTP header of all subsequent uplink G-PDUs that are related to the requested PDP context. When the source IP address of the Update PDP Context Request changes, this information element shall be included if the Cause contains the value 'Request accepted'.

The Tunnel Endpoint Identifier Signalling field specifies an uplink Tunnel Endpoint Identifier for signalling messages which is chosen by the GGSN. The SGSN shall include this Tunnel Endpoint Identifier in the GTP header of all subsequent uplink signalling messages which are related to the requested PDP context. This field shall not be present if a signalling tunnel for the given MS between the peer GSNs already exists.

The QoS values supplied in the Update PDP Context Request may be negotiated downwards by the GGSN. The negotiated values or the original value from SGSN is inserted in the Quality of Service Profile information element. This information element shall be included if the Cause contains the value 'Request accepted'.

If a connection-less (or an existing reliable connection oriented) path is to be used to tunnel T-PDUs for the given PDP context, the GGSN may start to forward T-PDUs after the Update PDP Context Response has been sent. The SGSN may start to forward T-PDUs when the Update PDP Context Response has been received. In this case the SGSN shall also be prepared to receive T-PDUs from the GGSN after it has sent an Update PDP Context Request but before an Update PDP Context Response has been received.

If a reliable connection-oriented path is to be used to tunnel T-PDUs for the given PDP context and a connection does not exist between the GSN pair, the SGSN shall establish a connection and the GGSN shall wait for the connection before forwarding of T-PDUs may start.

Only one connection shall be used between any given GSN-pair, and this connection shall be used to tunnel end user traffic in both directions.

The GGSN shall include a GGSN Address for signalling and an GGSN address for user traffic, which may differ from that provided by the underlying network service (e.g. IP). The SGSN shall store these GGSN Addresses and use them

when sending subsequent signalling on this GTP tunnel or G-PDUs to the GGSN for the MS. When active contexts are being redistributed due to load sharing, G-PDUs that are in transit across the Gn-interface are in an undetermined state and may be lost. When the source IP address of the Update PDP Context Request changes, the GGSN Address for user traffic shall be included if the Cause contains the value 'Request accepted'.

The GGSN shall include the Recovery information element into the Update PDP Context Response if the GGSN is in contact with the SGSN for the first time or if the GGSN has restarted recently and the new Restart Counter value has not yet been indicated to the SGSN. The SGSN receiving the Recovery information element shall handle it as when an Echo Response message is received but shall consider the PDP context as updated and active if the response cause indicates a successful operation at the GGSN.

The Charging ID is used to identify all charging records produced in SGSN(s) and the GGSN for this PDP context. The Charging ID has been previously generated by the GGSN and is unique for this PDP context. If an inter-SGSN routing area update occurs, it is transferred to the new SGSN as part of each active PDP context. When the source IP address of the Update PDP Context Request changes, this information element shall be included if the Cause contains the value 'Request accepted'.

The Charging Gateway Address is the IP address of the recommended Charging Gateway Functionality to which the SGSN should transfer the Charging Detail Records (CDR) for this PDP Context.

The optional Private Extension contains vendor or operator specific information.

Table 8: Information Elements in an Update PDP Context Response sent by a GGSN

Information element	Presence requirement	Reference
Cause	Mandatory	7.7.1
Recovery	Optional	7.7.11
Tunnel Endpoint Identifier Data I	Conditional	7.7.13
Tunnel Endpoint Identifier Signalling	Conditional	7.7.14
Charging ID	Conditional	7.7.26
GGSN Address for Signalling	Conditional	GSN Address 7.7.32
GGSN Address for User Traffic	Conditional	GSN Address 7.7.32
Quality of Service Profile	Conditional	7.7.34
Charging Gateway Address	Optional	7.7.43
Private Extension	Optional	7.7.44

The message can also be sent from a SGSN node to a GGSN node as a response of a GGSN-initiated Update PDP Context Request.

If the GGSN receives an Update PDP Context Response with a Cause value other than 'Request accepted', it shall abort the update of the PDP context.

Only the Cause information element and optionally the Recovery information element shall be included in the response if the Cause contains another value than 'Request accepted'.

Possible Cause values are the same as for the Update PDP Context Response sent by a GGSN.

The QoS values supplied in the Update PDP Context Request may be negotiated downwards by the SGSN. The negotiated values or the original value from GGSN is inserted in the Quality of Service Profile information element. This information element shall be included if the Cause contains the value 'Request accepted' and a QoS information element was supplied in the corresponding request message.

The SGSN shall include the Recovery information element into the Update PDP Context Response if the SGSN has restarted recently and the new Restart Counter value has not yet been indicated to the GGSN. The GGSN receiving the Recovery information element shall handle it as when an Echo Response message is received but shall consider the PDP context as updated and active if the response cause indicates a successful operation at the SGSN.

Table 9: Information Elements in an Update PDP Context Response sent by a SGSN

Information element	Presence requirement	Reference
Cause	Mandatory	7.7.1
Recovery	Optional	7.7.11
Quality of Service Profile	Conditional	7.7.34
Private Extension	Optional	7.7.44

**** Next Modified Section ****

7.5.5 SGSN Context Acknowledge

The new SGSN shall send an SGSN Context Acknowledge message to the old SGSN as a response to the SGSN Context Response message. Only after receiving the SGSN Context Acknowledge message, shall the old SGSN start to forward user data packets. SGSN Context Acknowledge indicates to the old SGSN that the new SGSN has correctly received PDP Context information and is ready to receive user data packets identified by the corresponding Tunnel Endpoint Identifier values.

Possible cause values are:

- 'Request accepted'.
- 'System failure'.
- 'Mandatory IE incorrect'.
- 'Mandatory IE missing'.
- 'Optional IE incorrect'.
- 'No resources available'.
- 'Invalid message format'.
- 'Version not supported'.
- 'Authentication failure'.

Only the Cause information element shall be included in the acknowledgement if the Cause contains a value other than 'Request accepted'.

For each active PDP context the new SGSN shall include a Tunnel Endpoint Identifier Data II information element. The Tunnel Endpoint Identifier Data II field specifies a Tunnel Endpoint Identifier which is chosen by the new SGSN for a particular PDP context. The old SGSN shall include this Tunnel Endpoint Identifier I in the GTP header of all subsequent G-PDUs which are sent from the old SGSN to the new SGSN and related to the particular PDP context. When active PDP context(s) exist, this information element shall be included if the Cause contains the value 'Request accepted'.

If any of the PDP contexts has a QoS reliability class which indicates that a reliable connection-oriented path should be used to forward T-PDUs coming via the old route and no connection has already been established, the old SGSN shall set-up a connection to the new SGSN after receiving SGSN Context Acknowledge message.

The new SGSN shall include an SGSN Address for user traffic, which may differ from that provided by the underlying network service (e.g. IP). The old SGSN shall store this SGSN Address and use it when sending G-PDUs to the new SGSN for the MS. When active PDP context(s) exist, this information element shall be included if the Cause contains the value 'Request accepted'.

The optional Private Extension contains vendor or operator specific information.

Table 28: Information Elements in a SGSN Context Acknowledge

Information element	Presence requirement	Reference
Cause	Mandatory	7.7.1
Tunnel Endpoint Identifier Data II	Conditional	7.7.15
SGSN Address for user traffic	Conditional	GSN Address 7.7.32
Private Extension	Optional	7.7.44

**** Next Modified Section ****

7.5.7 Forward Relocation Response

The new SGSN shall send a Forward Relocation Response to the old SGSN as a response to a previous Forward Relocation Request.

Possible Cause values is:

- 'Request Accepted'.
- 'System failure'.
- 'Mandatory IE incorrect'.
- 'Mandatory IE missing'.
- 'Optional IE incorrect'.
- 'No resources available'.
- 'Invalid message format'.
- 'Version not supported'.
- 'Relocation failure'.

RANAP Cause is mandatory if cause value is contained in RANAP message.

Target RNC Information, UTRAN transparent container and RANAP Cause are information from the target RNC in the new SGSN.

Single number or plural number of Target RNC Information parameter shall be set in this message. This information element shall be included if the Cause contains the value 'Request accepted'.

The Tunnel Endpoint Identifier Signalling field specifies a Tunnel Endpoint Identifier that is chosen by the new SGSN. The old SGSN shall include this Tunnel Endpoint Identifier in the GTP header of all subsequent signalling messages that are sent from the old SGSN to the new SGSN. This information element shall be included if the Cause contains the value 'Request accepted'.

The optional Private Extension contains vendor or operator specific information.

Table 30: Information Elements in a Forward Relocation Response

Information element	Presence requirement	Reference
Cause	Mandatory	7.7.1
Tunnel Endpoint Identifier Signalling	Conditional	7.7.14
RANAP Cause	Conditional	7.7.18
UTRAN transparent container	Optional	7.7.38
Target RNC Information	Conditional	7.7.39
Private Extension	Optional	7.7.44