

## **Presentation of Specification to TSG**

---

<b>Presentation to:</b>	<b>TSG SA Meeting #&lt;21&gt;</b>
<b>Document for presentation:</b>	<b>TS 23.246, Multimedia Broadcast/Multicast Service (MBMS)</b>
<b>Version</b>	<b>2.0.0</b>
<b>Presented for:</b>	<b>Approval</b>

---

### **Abstract of document:**

The presented document TS 23.246 describes the stage 2 description (architectural solution and functionalities) for MBMS, which includes the elements necessary to realise the stage 1 requirements in 3GPP TS 22.146.

TS 23.246 is now more than 80% complete and is ready for presentation for approval to SA.

TS 23.246 describes the architecture to support MBMS. A good overview of the architectures and procedures to support MBMS are shown.

### **Changes since last presentation to SA**

Refinement to MBMS Procedures

---

### **Outstanding Issues:**

Support of MBMS for GERAN has been discussed but has not been fully documented, however the assumption is that this functionality will be very similar to that for UTRAN. However it is the intention to identify any differences and if necessary present applicable change requests at the following SA meeting in December.

---

### **Contentious Issues:**

None at present

# 3GPP TS 23.246 V.2.0.0 (2003-09)

---

*Technical Specification*

## **3rd Generation Partnership Project; Technical Specification Group Services and System Aspects; Multimedia Broadcast/Multicast Service (MBMS); Architecture and Functional Description (Release 6)**

---



The present document has been developed within the 3<sup>rd</sup> Generation Partnership Project (3GPP™) and may be further elaborated for the purposes of 3GPP.

The present document has not been subject to any approval process by the 3GPP Organizational Partners and shall not be implemented. This Specification is provided for future development work within 3GPP only. The Organizational Partners accept no liability for any use of this Specification. Specifications and reports for implementation of the 3GPP™ system should be obtained via the 3GPP Organizational Partners' Publications Offices.

---

Keywords

---

Presence

**3GPP**

Postal address

---

3GPP support office address

---

650 Route des Lucioles - Sophia Antipolis  
Valbonne - FRANCE  
Tel.: +33 4 92 94 42 00 Fax: +33 4 93 65 47 16

Internet

---

<http://www.3gpp.org>

---

**Copyright Notification**

---

No part may be reproduced except as authorized by written permission.  
The copyright and the foregoing restriction extend to reproduction in all media.

© 2002, 3GPP Organizational Partners (ARIB, CWTS, ETSI, T1, TTA, TTC).  
All rights reserved.

# Contents

Foreword.....	4
1 Scope.....	5
2 References.....	5
3 Definitions and abbreviations.....	5
3.1 Definitions.....	5
3.2 Abbreviations.....	5
4 MBMS Architecture.....	6
4.1 Overview.....	6
4.2 Reference Architecture Model.....	7
4.3 MBMS Specific Reference points.....	7
4.3.1 Gmb.....	7
4.4 MBMS Service Provision.....	9
4.4.1 MULTICAST MODE.....	9
4.4.1.1 Subscription.....	10
4.4.1.2 Service announcement.....	10
4.4.1.3 Joining.....	11
4.4.1.4 Session Start.....	11
4.4.1.5 MBMS notification.....	11
4.4.1.6 Data transfer.....	11
4.4.1.7 Session Stop.....	11
4.4.1.8 Leaving.....	11
4.4.2 Multicast Mode timeline.....	11
4.4.2.1 Period between Service Announcement and Session Start.....	11
4.4.2.2 Period between Service Announcement and Service Subscription.....	11
4.4.2.3 Period between Service Announcement and Joining.....	11
4.4.2.4 Period between Joining and Session Start.....	12
4.4.2.5 Period between Session Start and First Data Arrival.....	12
4.4.2.6 Period between Session Start and Session Stop.....	12
4.4.3 BROADCAST MODE.....	12
4.4.3.1 Service announcement.....	14
4.4.3.2 Session Start.....	14
4.4.3.3 MBMS notification.....	14
4.4.3.4 Data transfer.....	14
4.4.3.5 Session Stop.....	14
4.4.4 Broadcast Mode timeline.....	15
4.4.4.1 Period between Service Announcement and Session Start.....	15
4.4.4.2 Period between Session Start and First Data Arrival.....	15
4.4.4.3 Period between Session Start and Session Stop.....	15
5 Functional Entities To Support MBMS.....	15
5.1 Broadcast-Multicast Service Centre (BM-SC).....	15
5.1.1 Content Provider Authentication, Authorization and Charging.....	15
5.1.2 MBMS Transport.....	15
5.1.3 MBMS Transmissions.....	15
5.1.4 Service Advertisement and Description.....	16
5.2 User Equipment.....	16
5.3 UTRAN/GERAN.....	16
5.4 SGSN.....	17
5.5 GGSN.....	17
5.6 MBMS Data Sources and Content Provider.....	17
5.7 Optional Functional Element.....	17
5.7.1 CSE.....	17
5.7.2 CBC.....	17
5.7.3 OSA-SCS.....	17

6	MBMS attributes and Parameters .....	18
6.1	MBMS UE Context .....	18
6.2	MBMS Bearer Context .....	18
6.3	Quality-of-Service .....	19
6.3.1	MBMS QoS distribution tree .....	20
6.4	Temporary Mobile Group Identity.....	20
8	MBMS Procedures .....	20
8.1	MBMS Notification .....	20
8.2	MBMS Multicast Service Activation.....	21
8.3	MBMS Session Start Procedure .....	23
8.4	MBMS Registration Procedure.....	24
8.5	MBMS Session Stop Procedure.....	26
8.6	MBMS De-Registration Procedure.....	27
8.6.1	BM-SC initiated MBMS De-Registration Procedure – .....	28
8.7	MBMS Multicast Service Deactivation .....	29
8.8	Iu Bearer Plane release procedure.....	31
8.9	RAN Resource Setup .....	31
8.10	Inter SGSN Routeing Area Update .....	31
8.11	Inter SGSN Serving RNS Relocation Procedure.....	33
8.12	MBMS Broadcast Service Activation .....	34
8.13	MBMS Broadcast service de-activation.....	34
8.14	MBMS Broadcast Session Start Procedure .....	34
9	Security .....	35
10	Charging requirement .....	36
Annex A (Informative):	Information flows .....	37
A.1	General information flow.....	37
Annex B	.....	37
Change history	.....	37

---

## Foreword

This Technical Specification has been produced by the 3<sup>rd</sup> Generation Partnership Project (3GPP).

The contents of the present document are subject to continuing work within the TSG and may change following formal TSG approval. Should the TSG modify the contents of the present document, it will be re-released by the TSG with an identifying change of release date and an increase in version number as follows:

Version x.y.z

where:

- x the first digit:
  - 1 presented to TSG for information;
  - 2 presented to TSG for approval;
  - 3 or greater indicates TSG approved document under change control.
- y the second digit is incremented for all changes of substance, i.e. technical enhancements, corrections, updates, etc.
- z the third digit is incremented when editorial only changes have been incorporated in the document.

---

# 1 Scope

The present document describes the stage 2 description (architectural solution and functionalities) for MBMS, which includes the elements necessary to realise the stage 1 requirements in 3GPP TS 22.146 [2].

The present document includes information applicable to network operators, service providers and manufacturers.

---

## 2 References

The following documents contain provisions which, through reference in this text, constitute provisions of the present document.

- References are either specific (identified by date of publication, edition number, version number, etc.) or non-specific.
- For a specific reference, subsequent revisions do not apply.
- For a non-specific reference, the latest version applies. In the case of a reference to a 3GPP document (including a GSM document), a non-specific reference implicitly refers to the latest version of that document *in the same Release as the present document*.

- [1] 3GPP TR 21.905: "3G Vocabulary".
- [2] 3GPP TS 22.146: "MBMS; Stage 1".
- [3] 3GPP TS 23.107: "QoS Concept and Architecture"
- [4] 3GPP TS 29.061: "Interworking between the Public Land Mobile Network (PLMN) supporting Packet Based Services and Packet Data Networks (PDN)"

---

## 3 Definitions and abbreviations

### 3.1 Definitions

For the purposes of the present document, the terms and definitions defined in 3GPP TS 21.905 [1] and 3GPP TS 22.146 [2] and the following apply:

**MBMS Service Announcement:** Mechanism to allow users to be informed about the MBMS services available.

**MBMS Bearer Service:** the service provided by the PS Domain to MBMS User Services to deliver IP multicast datagrams to multiple receivers using minimum network and radio resources.

**MBMS User Service:** the MBMS service provided to the end user by means of the MBMS Bearer Service and possibly other capabilities.

### 3.2 Abbreviations

For the purposes of the present document, the abbreviations in 3GPP TS 21.905 [1] and 3GPP TS 22.141 [2] and the following apply:

---

## 4 MBMS Architecture

### 4.1 Overview

MBMS is a point-to-multipoint service in which data is transmitted from a single source entity to multiple recipients. Transmitting the same data to multiple recipients allows network resources to be shared.

The MBMS offers two modes:

- Broadcast Mode
- Multicast Mode

MBMS architecture enables the efficient usage of radio-network and core-network resources, with an emphasis on radio interface efficiency.

MBMS is realised by the addition of a number of new capabilities to existing functional entities of the 3GPP architecture and by addition of a number of new functional entities.

The existing PS Domain functional entities (GGSN, SGSN, UTRAN, GERAN and UE) are enhanced to provide the 'MBMS Bearer Service'. In the user plane, this service provides delivery of IP Multicast datagrams from the Gi reference point to UEs with a specified Quality of Service. In the control plane, this service provides mechanisms for:

- managing the MBMS bearer service activation status of UEs (in the case of multicast)
- outsourcing authorisation decisions to the MBMS User Service (i.e. to the BM-SC) (in the case of multicast)
- providing control of session initiation/termination by the MBMS User Service and managing bearer resources for the distribution of MBMS data (in the case of multicast and broadcast)

A particular instance of the MBMS Bearer Service is identified by an IP Multicast Address and an APN Network Identifier.

The boundary of the MBMS Bearer Service is the Gmb and Gi reference points as shown in Section 4.3 below. The former provides the control plane functions and the latter the user plane.

A functional entity, the Broadcast Multicast Service Centre (BM-SC) provides a set of functions for MBMS User Services. BM-SC functions for different MBMS User Services may be supported from the same or different physical network elements.

## 4.2 Reference Architecture Model

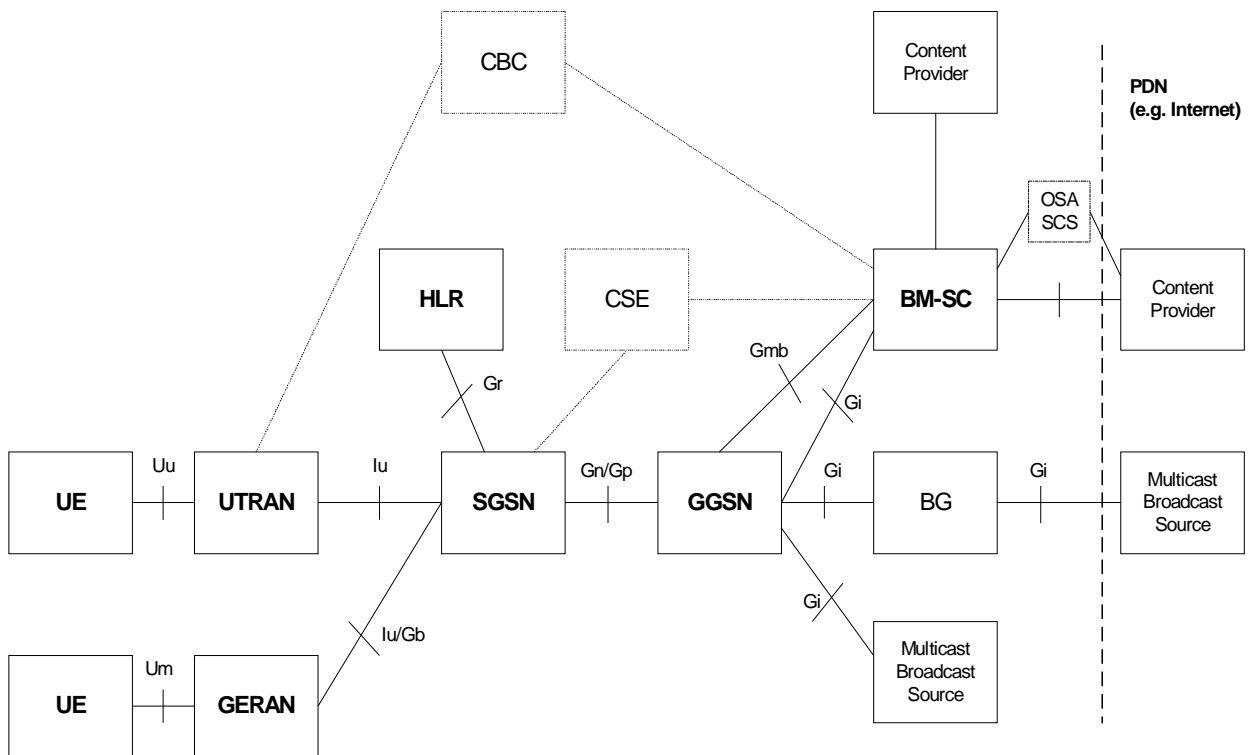

Note: dotted lines means functions / reference points that are FFS. Gp applies only when SGSN and GGSN are in different PLMN.

**Figure 1: Reference architecture to support MBMS**

## 4.3 MBMS Specific Reference points

### 4.3.1 Gmb

Signalling between GGSN and BM-SC is exchanged at Gmb reference point. This represents the network side boundary of the MBMS Bearer Service from a control plane perspective. This includes user specific MBMS signalling and MBMS service specific signalling.

MBMS service specific Gmb signalling:

- The GGSN establishes the MBMS bearer context and registers at BM-SC.
- The GGSN or the BM-SC releases the MBMS bearer context and de-register the GGSN from the BM-SC.
- The BM-SC indicates session start and stop to the GGSN including session attributes like QoS or multicast area.

User specific Gmb signalling:

- The BM-SC authorises the user specific MBMS multicast service activation (join) at the GGSN.
- The GGSN reports to the BM-SC the successful user specific MBMS multicast activation (join) to allow the BM-SC to synchronise the BM-SC UE MBMS context and charging with the MBMS UE contexts in SGSN and GGSN.



- The GGSN reports to the BM-SC when a user specific MBMS multicast service is released or deactivated (e.g. when the radio contact is lost) to synchronise BM-SC UE MBMS contexts and charging with the MBMS UE contexts in SGSN and GGSN.

The BM-SC initiates the deactivation of a user specific MBMS multicast service when the MBMS service is terminated at application layer.

## 4.4 MBMS Service Provision

### 4.4.1 MULTICAST MODE

Reception of an MBMS MULTICAST service is enabled by certain procedures that are illustrated in the Figure below.

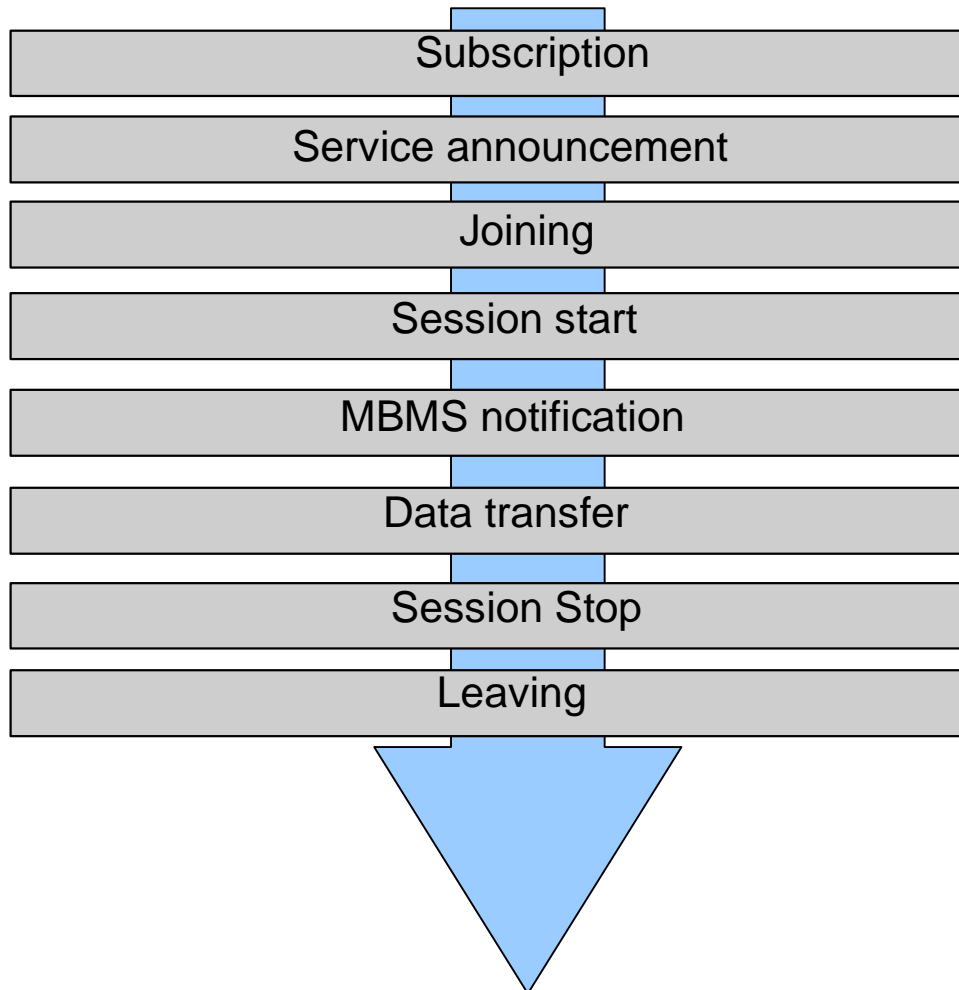

**Figure 2: Phases of MBMS Multicast service provision**

The phases subscription, joining and leaving are performed individually per user. The other phases are performed for a service, i.e. for all users interested in the related service. The sequence of phases may repeat, e.g. depending on the need to transfer data. Also subscription, joining, leaving, service announcement as well as MBMS notification may run in parallel to other phases.

This is illustrated with the following example of timeline:

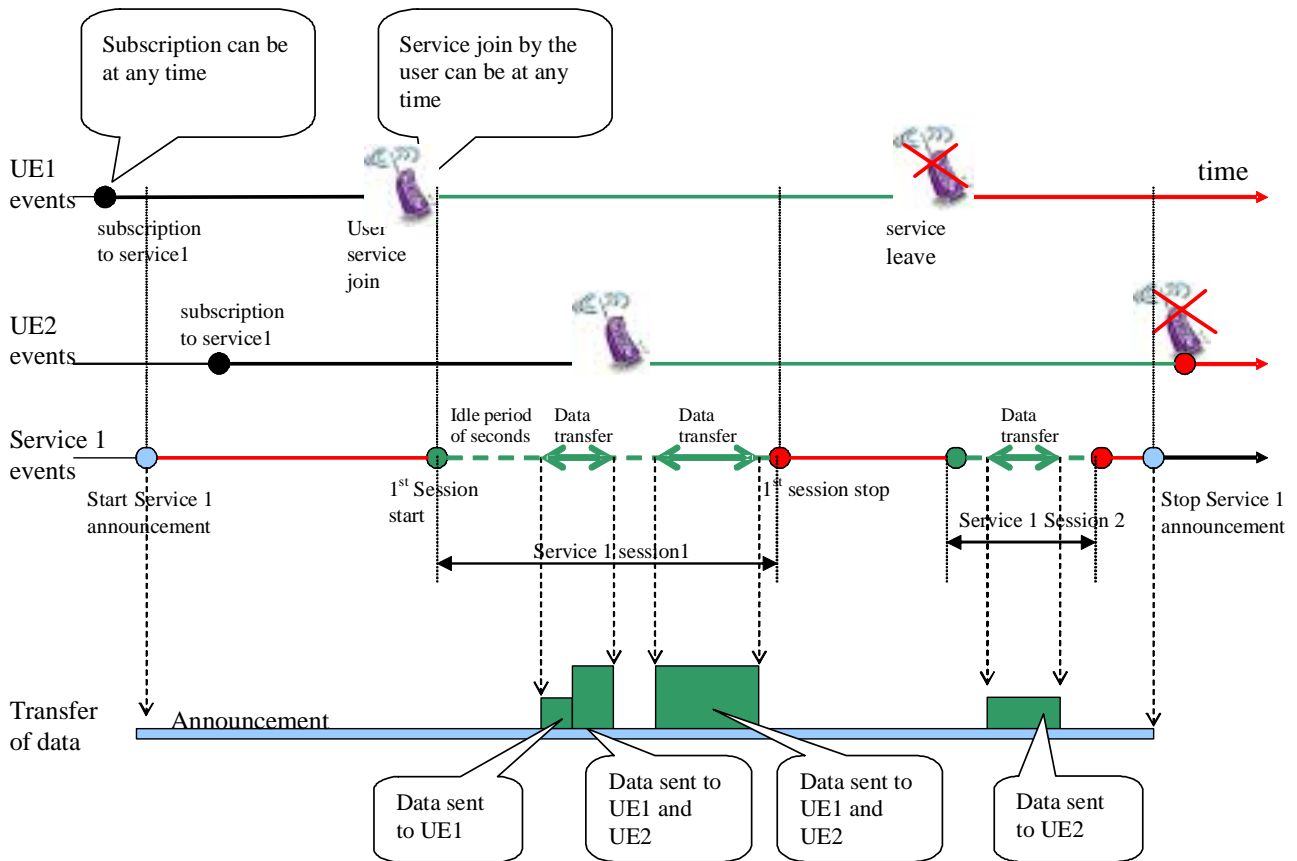

**Figure 3: Timeline example**

#### 4.4.1.1 Subscription

Establishes the relationship between the user and the service provider, which allows the user to receive the related MBMS multicast service.

Service Subscription is the agreement of a user to receive service(s) offered by the operator. Subscription information is recorded in the appropriate database(s) in the operator's network.

#### 4.4.1.2 Service announcement

MBMS service announcement/discovery mechanisms shall allow users to request or be informed about the range of MBMS services available. This includes operator specific MBMS services as well as services from content providers outside of the PLMN. Service announcement is used to distribute to users information about the service, parameters required for service activation (e.g. IP multicast address) and possibly other service related parameters (e.g. service start time).

Operators/service providers may consider several service discovery mechanisms. This could include standard mechanisms such as SMS, or depending on the capability of the terminal, applications that encourage user interrogation. The method chosen to inform users about MBMS services may have to account for the users location, (e.g. current cell, in the HPLMN or VPLMN). Users who have not already subscribed to a MBMS service should also be able to discover MBMS services.

The following could be considered useful for MBMS service announcement mechanisms (not exhaustive): -

- CBS
- MBMS Broadcast mode to advertise MBMS Multicast and Broadcast Services

- MBMS Multicast mode to advertise MBMS Multicast Services
- PUSH mechanism (WAP, SMS-PP, MMS)
- URL (HTTP, FTP)

The details of the MBMS service announcement mechanisms are not specified, but MBMS shall allow the utilisation of solutions using IETF protocols.

#### 4.4.1.3 Joining

Joining (i.e. MBMS multicast activation by the user) is the process by which a subscriber joins (becomes a member of) a multicast group, i.e. the user indicates to the network that he/she is willing to receive Multicast mode data of a specific service.

#### 4.4.1.4 Session Start

Session Start is the point at which the BM-SC is ready to send data. This can be identified with the start of a “Multicast session” as defined in the Stage 1. Session Start occurs independently of activation of the service by the user – i.e. a given user may activate the service before or after Session Start. Session Start is the trigger for network resources establishment for MBMS data transfer.

#### 4.4.1.5 MBMS notification

Informs the UEs about forthcoming (and potentially about ongoing) multicast data transfer.

#### 4.4.1.6 Data transfer

Is the phase when MBMS data are transferred to the UEs. Arrival of the first packet at the GGSN may coincide with Session Start.

#### 4.4.1.7 Session Stop

Is the point at which the BM-SC determines that there will be no more data to send for some period of time – this period being long enough to justify removal of network resources associated with the session. At Session Stop, the network resources are released.

#### 4.4.1.8 Leaving

Leaving (i.e. MBMS multicast deactivation by the user) is the process by which a subscriber leaves (stops being a member of) a multicast group, i.e. the user no longer wants to receive Multicast mode data of a specific service.

### 4.4.2 Multicast Mode timeline

#### 4.4.2.1 Period between Service Announcement and Session Start

The service announcement may contain a schedule of Session Start times and may be sent some time before the service is due to start. So, this time period could be hours, days or even weeks.

#### 4.4.2.2 Period between Service Announcement and Service Subscription

Service Subscription can be done anytime before or after Service announcement.

#### 4.4.2.3 Period between Service Announcement and Joining

The Joining time is chosen by the user possibly in response to a Service Announcement. Users will typically join at the time of their choosing so that the period between announcement and joining may be very long or very short.

#### 4.4.2.4 Period between Joining and Session Start

Some services may be 'always on'. In this case, Joining can take place starting immediately after Service Announcement and possibly many hours before, or after, Session Start.

In other cases, if a Session Start time is known, Joining may take place immediately before Session Start or after Session Start. For these services, the announcement may contain some indication of a time period within which users should choose a time to Join the service.

#### 4.4.2.5 Period between Session Start and First Data Arrival

Session Start indicates that the transmission is about to start. The time delay between a Session Start indication and actual data should be long enough for the network actions required at Session Start to take place e.g. provision of service information to the UTRAN, establishment of the user plane.

Session Start may be triggered by an explicit notification from the BM-SC or by first data arrival at the GGSN. In the case of user-plane resources which are set-up after the start of session data transmission, the network is not required to buffer the session data and loss of data can be assumed.

#### 4.4.2.6 Period between Session Start and Session Stop

When the BM-SC knows that there is no more data to be sent for a "long idle period", it should indicate Session Stop to the network, causing the release of network resources. However, if this idle period with no data is short, this may not be appropriate as it brings more signalling and processing.

There is no absolute value on the duration of this "long idle period". The order of magnitude (i.e. is it closer to 30 seconds or 30 minutes) is to be defined taking into account UTRAN constraints.

### 4.4.3 BROADCAST MODE

An example for the phases of MBMS broadcast service provision is described in the figure below.

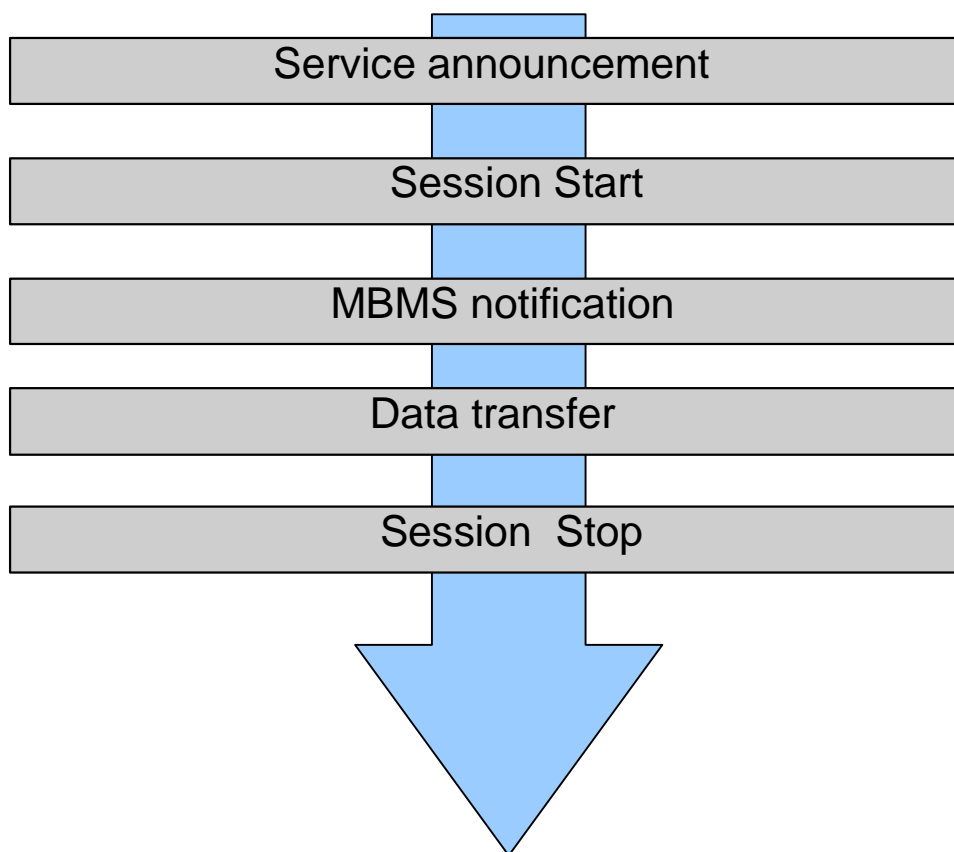

**Figure 4: Phases of MBMS broadcast service provision**

The sequence of phases may repeat, e.g. depending on the need to transfer data. It is also possible that the service announcement and MBMS notification phase may run in parallel with other phases, in order to inform UEs which have not yet received the related service.

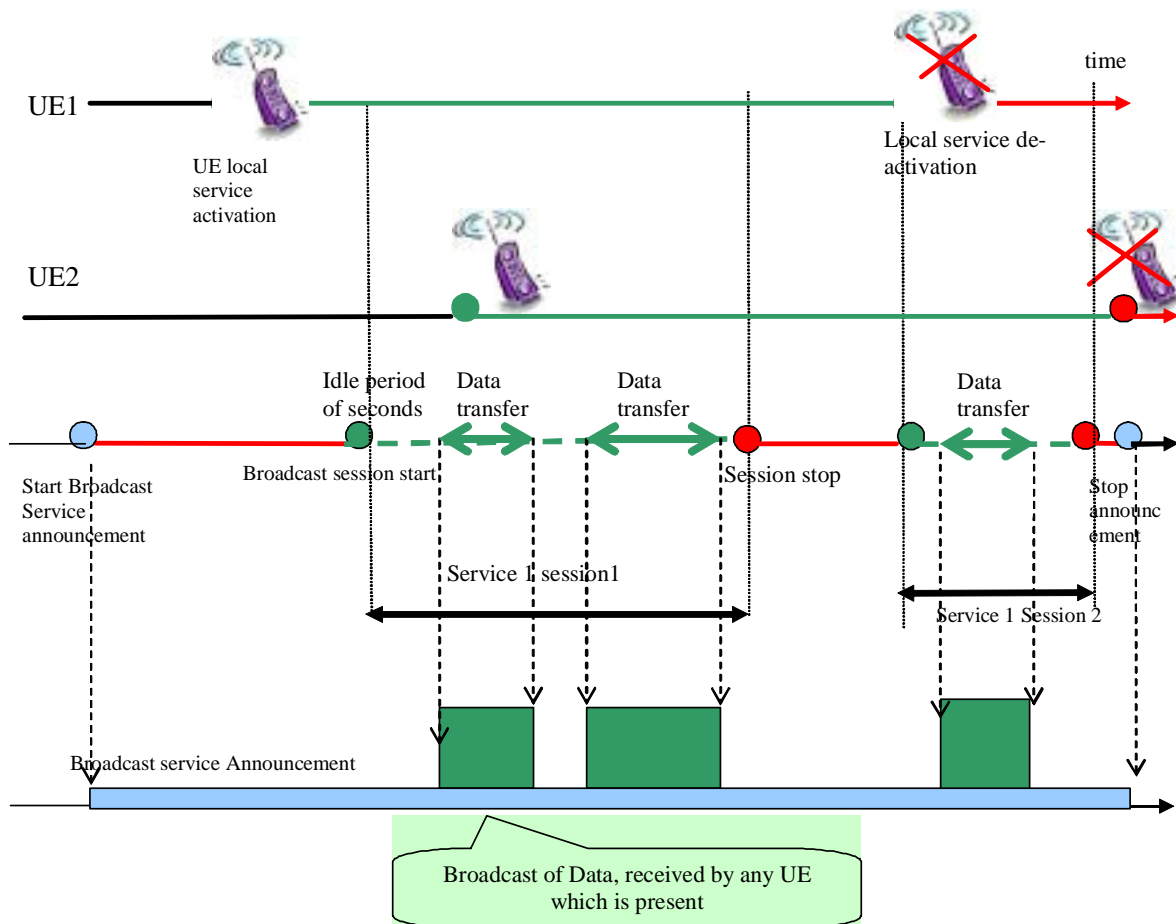

**Figure 5 Broadcast service timeline**

**4.4.3.1 Service announcement**

Informs UEs about forthcoming services. Also see section on Multicast mode (4.4.1.2)

**4.4.3.2 Session Start**

Session Start is the point at which the BM-SC is ready to send data. This can be identified with the start of a “Broadcast session” as defined in the Stage 1. Session Start occurs independently of Service Activation by the user – i.e. a given user may activate the service before or after the start of the session. Session Start is the trigger for network resources establishment for MBMS data transfer.

**4.4.3.3 MBMS notification**

Informs the UEs about forthcoming (and potentially about ongoing) broadcast data transfer.

**4.4.3.4 Data transfer**

Is the phase when MBMS data are transferred to the UEs.

**4.4.3.5 Session Stop**

Is the point at which the MBMS application determines that there will be no more data to send for some period of time – this period being long enough to justify removal of network resources associated with the service. At Session Stop, the network resources are released.

## 4.4.4 Broadcast Mode timeline

### 4.4.4.1 Period between Service Announcement and Session Start

Same as for Multicast mode.

### 4.4.4.2 Period between Session Start and First Data Arrival

Same as for Multicast mode.

### 4.4.4.3 Period between Session Start and Session Stop

Same as for Multicast mode.

---

# 5 Functional Entities To Support MBMS

To provide MBMS services existing functional entities, GGSN, SGSN, RNC/BSC, perform several MBMS related functions and procedures, some of which are specific to MBMS. An MBMS specific functional entity – Broadcast Multicast Service Centre (BM-SC) supports various MBMS specific service provisioning and delivery.

## 5.1 Broadcast-Multicast Service Centre (BM-SC)

The BM-SC provides functions for service provisioning and delivery. It may serve as an entry point for content provider MBMS transmissions, used to authorise and initiate MBMS Bearer Services within the PLMN and can be used to schedule and deliver MBMS transmissions.

The BM-SC is a functional entity which must exist for each MBMS User Service.

This section describes BM-SC functions which are defined for the standardised MBMS User Services. Which of these functions are provided as general purpose capabilities to be used by multiple MBMS User Services and which are specific to a particular MBMS User Service is defined in conjunction with the definition of the standardised MBMS User Services.

### 5.1.1 Content Provider Authentication, Authorization and Charging

The BM-SC shall be able to authenticate 3<sup>rd</sup> party content providers, providing content for MBMS transmissions.

3<sup>rd</sup> party content providers may wish to initiate an MBMS transmission. In such cases, the BM-SC shall be able to authorize content providers to transmit data over MBMS depending on operator policy.

The BM-SC shall be able to verify the integrity of data received from content providers.

The BM-SC shall be able to generate charging records for content provider transmitted data.

### 5.1.2 MBMS Transport

The BM-SC shall be able to provide the GGSN with transport associated parameters such as quality-of-service and multicast/broadcast area.

The BM-SC shall be able to initiate and terminate MBMS transport resources prior to and following transmission of MBMS data.

### 5.1.3 MBMS Transmissions

The BM-SC should be able to accept content from external sources and transmit it using error resilient schemes (e.g. specialized MBMS codecs).



Further, the BM-SC might be used to schedule MBMS session transmissions, retrieve content from external sources and provide this content using MBMS transport resources.

The BM-SC should be able to schedule session retransmissions, and label each session with an MBMS Session Identifier to allow the UE to distinguish the session retransmissions. These retransmissions are transparent to the RAN and MBMS user service.

### 5.1.4 Service Advertisement and Description

The BM-SC shall be able to provide service announcements for multicast and broadcast services.

The BM-SC shall be able to provide the UE with media descriptions specifying the media to be delivered as part of an MBMS (e.g. type of video and audio encodings).

The BM-SC shall be able to provide the UE with session descriptions specifying the sessions to be delivered as part of an MBMS (e.g. multicast service identification, addressing, time of transmission, etc.)

The BM-SC shall be able to deliver media and session descriptions by means of service announcements using IETF specified protocols over MBMS multicast and broadcast bearers

## 5.2 User Equipment

The UE shall support functions for the activation/deactivation of the MBMS service.

Once a particular MBMS service is activated, no further explicit user request is required to receive MBMS data although the user may be notified that data transfer is about to start.

The UE shall support security functions as appropriate for MBMS

The UE should, depending on terminal capabilities, be able to receive MBMS service announcements, paging information (non MBMS specific) or support simultaneous services (For example the user can originate or receive a call or send and receive messages whilst receiving MBMS video content). Reception of this paging or announcements may however, create losses in the MBMS data reception. The MBMS application should be able to cope with such losses.

Some UE depending upon terminal capability, may be able to store MBMS data. (This may involve DRM but this is out of scope of this specification)

The MBMS Session Identifier contained in the notification to the UE shall enable the UE to decide whether it needs to ignore the forthcoming transmission of MBMS session (e.g., because the UE has already received this session).

## 5.3 UTRAN/GERAN

UTRAN/GERAN are responsible for efficiently delivering MBMS data to the designated multicast or broadcast service area.

Efficient delivery of MBMS data in multicast mode may require mechanisms in the UTRAN/GERAN. E.G. The number of users within a cell prior to and during MBMS transmission could be used to . choose an appropriate radio bearer.

MBMS transmissions may be initiated and terminated intermittently. The UTRAN/GERAN shall support the initiation and termination of MBMS transmissions by the core-network. Further, the UTRAN/GERAN shall be able to receive MBMS data from the core-network over Iu bearers shared by many UEs.

The UTRAN/GERAN shall support intra-RNC/BSC, inter-RNC/BSC mobility of MBMS receivers. Mobility is expected to cause limited data loss. Therefore, MBMS applications should be able to cope with potential data loss caused by UE mobility.

The UTRAN/GERAN shall be able to transmit MBMS service announcements, paging information (non MBMS specific) and support other services in parallel with MBMS (For example Depending on terminal capabilities the user could originate or receive a call or send and receive messages whilst receiving MBMS video content).

## 5.4 SGSN

The SGSN role within MBMS architecture is to perform user individual network control functions and to provide MBMS transmissions to RAN/GERAN.

The SGSN shall provide support for intra-SGSN and inter-SGSN mobility procedures. Specifically this requires the SGSN to store a user-specific MBMS context for each activated multicast service and to pass these contexts to the new SGSN during inter-SGSN mobility procedures.

The SGSN shall be able to generate charging data per multicast service for each user. Further, the SGSN may provide functions to support the charging of prepaid users

The SGSN shall be able to establish Iu and Gn bearers shared by many users on demand when data has to be transferred to the users. This shall be done upon notification from the GGSN. Likewise, when data is no longer available the SGSN shall be able to tear down these bearers upon notification from the GGSN.

## 5.5 GGSN

The GGSN role within the MBMS architecture is to serve as an entry point for IP multicast traffic as MBMS data. Upon notification from the BM-SC the GGSN shall be able to request the establishment of a user-plane for a broadcast or multicast MBMS transmission. Further, upon BM-SC notification the GGSN shall be able to tear down the established user plane. User-plane establishment for multicast services is carried out towards those SGSNs that have requested to receive transmissions for the specific multicast service

The GGSN shall be able to receive IP multicast traffic (whether from BM-SC or other data sources) and to route this data to the proper GTP tunnels set-up as part of the service.

Other functions to note here that GGSN may provide in support of MBMS service but not exclusive to MBMS are:

- Message Screening (not needed if the MBMS sources are internal in the PLMN)
- Charging Data Collection
- Service (QoS) negotiation

## 5.6 MBMS Data Sources and Content Provider

The reference point from the content provider to the BM-SC is not standardised

## 5.7 Optional Functional Element

Note: The following are FFS

### 5.7.1 CSE

The SGSN may use CAMEL to handle pre-paid services, e.g. credit checking for on-line charging.

### 5.7.2 CBC

The Cell Broadcast Centre (CBC) may be used to announce MBMS services to the users.

### 5.7.3 OSA-SCS

The BM-SC might use OSA-SCS to interact with third parties.

## 6 MBMS attributes and Parameters

### 6.1 MBMS UE Context

The MBMS UE Context contains UE-specific information related to a particular MBMS bearer that the UE has joined. An MBMS UE Context is created in the UE, SGSN and GGSN when the UE joins an MBMS bearer. In the SGSN, an MBMS UE Context is also created as a result of an inter-SGSN routing area update after the transfer of the MBMS UE Context from the old SGSN. It is FFS whether MBMS UE Contexts are created in the BM-SC.

All MBMS UE Contexts of a UE (referenced as “UE Link” in RNC) are provided via UE dedicated Iu procedure(s) to the SRNC when the first PS RAB is established for the UE, or when the UE performs MBMS Multicast Service Activation. MBMS UE Contexts are provided to the SRNC regardless whether MBMS Sessions are ongoing or not (i.e. before, between and after Sessions).

In the UE, SGSN and GGSN, the MBMS UE Context is stored as part of the MM Context for the UE. There is one MBMS UE Context per MBMS bearer that the UE has joined.

In the RNC, the MBMS UE Contexts are stored as part of the UE Context of the RNC.

The content of the MBMS UE Context is described in Table 1.

**Table 1: MBMS UE Context**

Parameter	Description	UE	SGSN	GGSN	RNC	BM-SC
IP multicast address	IP multicast address identifying an MBMS bearer that the UE has joined.	X	X	X	X	FFS
APN	Access Point Name on which this IP multicast address is defined.	X	X	X	X	
TMGI	Temporary Mobile Group Identity allocated to the MBMS bearer.	X	X	FFS	X	
Linked NSAPI	NSAPI of the PDP context used by the UE to carry IGMP/MLD signalling.	X	X	X		
FFS	FFS					

### 6.2 MBMS Bearer Context

The MBMS Bearer Context, which is referred to as MBMS Service Context in RAN, contains all information describing a particular bearer of an MBMS service and is created in each node involved in the delivery of the MBMS data.

An MBMS Bearer Context is created in the SGSN and GGSN when the first MBMS UE Context is created in the node or when a downstream node requests it. The MBMS Bearer Context is statically configured in the BM-SC; how this is done is out of the scope of this specification. The MBMS Bearer Context is created in the SRNC when a first MBMS UE Context is created in SRNC. Session Start procedure may create MBMS Bearer Context in an RNC which has no MBMS Bearer Context yet. Furthermore, it is FFS whether the state model described below is applicable as such to the RAN or whether it needs to be extended to cover the case of the RAN properly.

An MBMS Bearer Context, once created, can be in one of two states reflecting the activity status of the corresponding MBMS bearer.

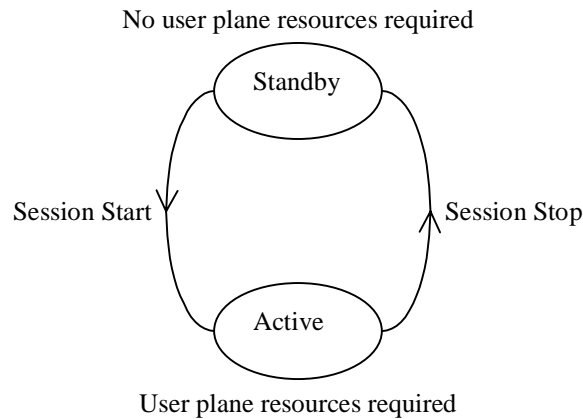

**Figure 6: MBMS Bearer Context State Model**

‘Active’ reflects the state of an MBMS Bearer Context in which user plane resources are required in the network for the transfer of MBMS data. This state is maintained as long as there is a corresponding MBMS session ongoing.

‘Standby’ reflects the state of an MBMS Bearer Context in which no user plane resources are required in the network for the transfer of MBMS data. This state is maintained as long as there is no corresponding MBMS session ongoing.

The content of the MBMS Bearer Context is described in Table 2.

**Table 2: MBMS Bearer Context**

Parameter	Description	RAN	SGSN	GGSN	BM-SC
IP multicast address	IP multicast address identifying the MBMS bearer described by this MBMS Bearer Context.	X	X	X	X
APN	Access Point Name on which this IP multicast address is defined.	X	X	X	FFS
TMGI	Temporary Mobile Group Identity allocated to the MBMS bearer.	X	X	X	X
State	State of activity of the MBMS bearer (‘standby’ or ‘active’)	FFS	X	X	X
QoS	Quality of Service required for the MBMS bearer.	X	X	X	X
MBMS Service Area	Area over which the MBMS service has to be distributed.	X	X	X	X
List of downstream nodes	List of downstream nodes that have requested the MBMS bearer and to which notifications and MBMS data have to be forwarded.		X	X	X
Number of UEs <sup>1)</sup> (FFS)	Number of UEs hosted by the node that have joined the multicast service.	FFS	X	X	FFS
FFS	FFS				

**Editor’s note 1:** Number of UEs may be used to determine when the last UE leaves the node and/or for content-provider charging. The RAN knows how many UEs in RRC-CONNECTED mode are interested in a multicast service, however it does not know how many UEs in RRC-IDLE mode are interested in the service, hence the meaning and relevance of this parameter for the RAN are FFS.

## 6.3 Quality-of-Service

It shall be possible for the network to control quality-of-service parameters for multicast and broadcast sessions. All QoS attributes described in [3] are applicable to MBMS. Compared to point-to-point bearer services the following limitations exist:

- For **traffic class**, only the background and streaming classes shall be supported.
- For **SDU error ratio**, only higher values are supported, i.e. the values describing higher numbers of lost or corrupted SDUs (actual values are FFS).

MBMS bearers of background class are best suited for the transport of MBMS user services such as messaging or downloading. As for point-to-point bearers, the network should, as far as possible, avoid dropping packets transported by a background class bearer. Instead, buffering and shaping schemes should be applied to the traffic flow to adapt to the available resources and changing network conditions. The total transfer time is not critical for background class bearers since the content must normally have been received in totality and stored in the UE before the user can access it.

MBMS bearers of streaming class are best suited for the transport of MBMS user services such as streaming. As for point-to-point bearers, the network should minimise the packet transfer delay of streaming class bearers as far as possible. Packet dropping should be the preferred traffic conditioning action applied to the traffic flow to adapt to the available resources.

MBMS user services that would normally use MBMS bearers of background class may however need to use a streaming class MBMS bearer. This will allow to transfer each MBMS data unit at almost the same point in time in all cells of the MBMS service area, as otherwise UEs moving between cells while an MBMS session is ongoing may experience high packet loss due to possible time offsets of the data transmission between cells. The amount of packet loss depends on this time offset, the cell change time and the bitrate in particular. Otherwise the MBMS user service will have to provide sufficient redundancy within the data to be able to cope with the high packet loss.

As the MBMS bearer transfers data to many UEs in parallel and because of the lack of feedback channel on radio level low SDU error ratios are difficult to achieve. When the resulting packet error ratio is not suitable for the application or when prevention of data loss is required, an MBMS user service may perform retransmission of MBMS data over point-to-point PDP bearer services on request from the receiver.

### 6.3.1 MBMS QoS distribution tree

MBMS data will be distributed to multiple users through a MBMS distribution tree that can go through many RNCs and many SGSNs. Furthermore some transport resources may be shared between many users accessing the same service in order to save resources. As a result, each branch of a MBMS distribution tree shall be established with the same QoS.

MBMS distribution tree shall have the same QoS for all its branches.

When a branch of the MBMS distribution tree has been created, it should not be possible for construction of another branch due to arrival of a new UE (or change of location of a UE with removal of a branch and addition of a new one) to impact the already established branches.

QoS value negotiation between UMTS network elements is not required. This implies that some branches may not be established if QoS requirement cannot be accepted by the concerned network node.

QoS re-negotiation feature in the RNC should not be allowed for MBMS service.

## 6.4 Temporary Mobile Group Identity

Temporary Mobile Group Identity (TMGI) is used for group notification purpose. The BM-SC will allocate a TMGI per service that is unique within HPLMN. For Multicast Service the TMGI will be transmitted to UE via service activation procedure.

---

# 8 MBMS Procedures

## 8.1 MBMS Notification

When a Session starts, UEs interested in the service (PMM-CONNECTED UEs and PMM-IDLE UEs) shall be notified.

Session attributes such as Service Id and the Multicast Area are made available in all interested RNCs during the Session Start procedure. Other parameters are FFS.

For radio efficiency reasons, the UTRAN may select on per cell basis whether to establish point-to-point or point-to-multipoint links for the distribution of MBMS data to the UEs.

In order to perform this selection, the UTRAN requests UEs to move to PMM-CONNECTED / RRC-CONNECTED state by means of MBMS group notification sent in the Multicast Area.

The fact that this group notification moves the UEs back to PMM-CONNECTED or to RRC-CONNECTED state is FFS, subject to RAN decision.

The exact number of UEs moved to PMM-CONNECTED / RRC-CONNECTED state is a decision of RAN node. It is not necessary for all UEs to move to PMM-CONNECTED/ RRC\_CONNECTED in order for the RAN to decide to use point-to-multipoint, other UEs may remain in IDLE state. This is a UTRAN choice (based on RRM criteria...), FFS in RAN group.

Following the decision to set up point-to-point or point-to-multipoint links, the number of UEs that need to be maintained in CONNECTED state or moved to IDLE state for MBMS data reception is also an decision of a RAN node.

GERAN functionality is FFS.

## 8.2 MBMS Multicast Service Activation

The MBMS multicast service activation procedure registers the user in the network to enable the reception of data from a specific MBMS multicast service. The activation is a signalling procedure between the UE and the network. The procedure establishes MBMS UE contexts in UE, SGSN and GGSN and RNC for each activated MBMS multicast service comparable to regular PDP contexts.

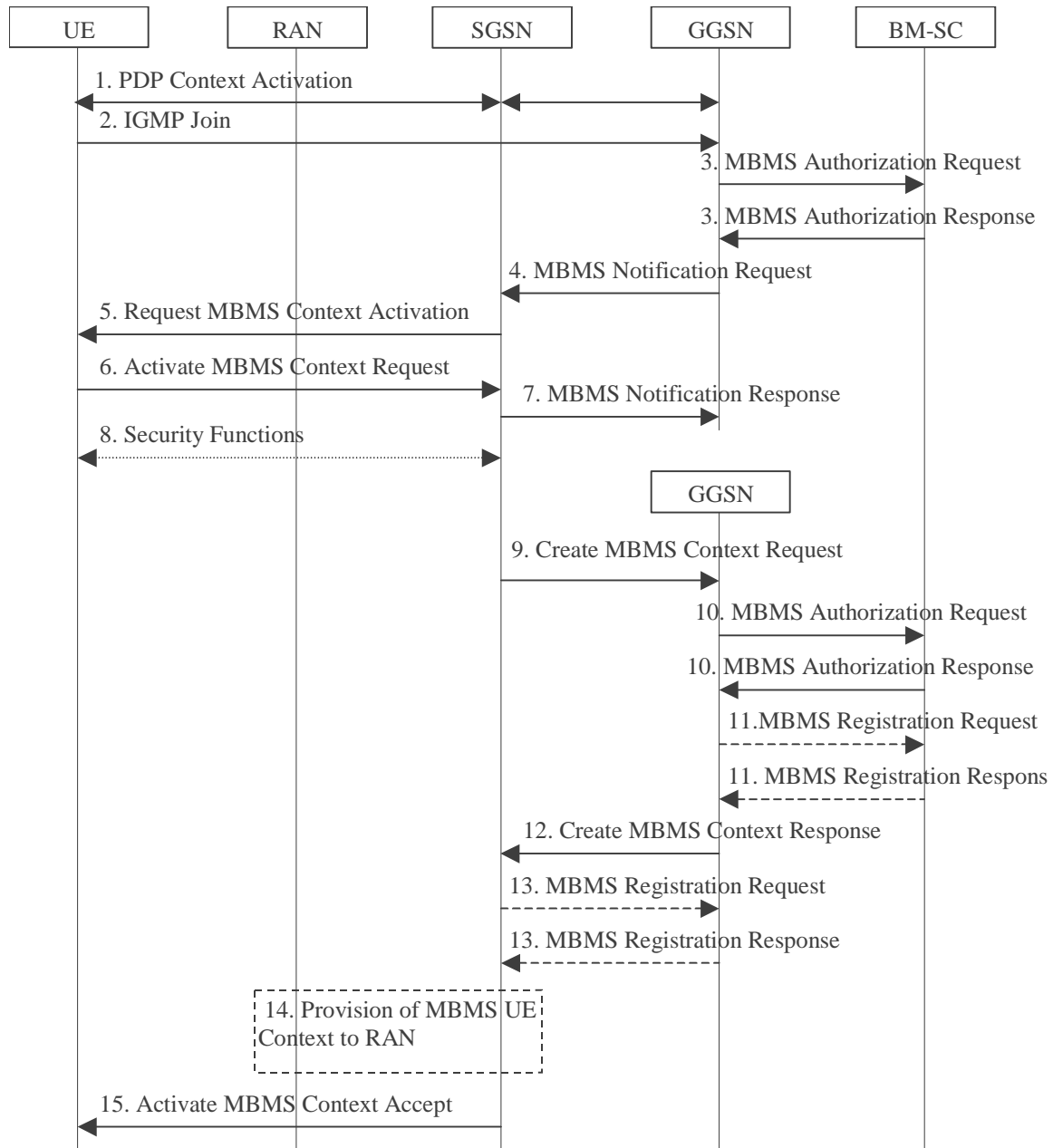

**Figure 7. The activation of an MBMS multicast service**

1. The UE activates a default, typically best-effort PDP context if not already established. This can be a PDP context used for basic IP services like WAP or Internet access, or it might be the signalling PDP context used for IMS access.
2. The UE sends an IGMP (IPv4) or MLD (IPv6) Join message over the default PDP context to signal its interest in receiving a particular multicast service identified by an IP multicast address.
3. The GGSN sends an MBMS Authorization Request seeking authorization for the activating UE to receive data. The authorization decision is provided in the MBMS Authorization Response together with the APN to be used for creation of the MBMS UE context. If the MBMS Authorization Response indicates that the UE is not authorized to receive the MBMS data the process terminates with no additional message exchange.
4. The GGSN receives the IGMP/MLD Join request and sends an MBMS Notification Request (IP multicast address, APN, Linked NSAPI) to the SGSN. Linked NSAPI is set equal to the NSAPI of the PDP context over which the Join request was received. The IP multicast address is the one requested by the UE in the Join request. The APN may be different from the APN to which the default PDP context has been activated. In any case, the

APN may resolve to a GGSN that is different from the GGSN receiving the IGMP/MLD Join request. . The GGSN starts a MBMS Activation Timer as GGSN may receive no response, e.g. in case SGSN or UE does not support MBMS.

5. The SGSN sends a Request MBMS Context Activation (IP multicast address, APN, Linked NSAPI) to the UE to request it to activate an MBMS context. Linked NSAPI allows the UE to associate the MBMS Context with the PDP context over which it sent the IGMP/MLD Join message in step 2.
6. The UE creates an MBMS UE context and sends an Activate MBMS Context Request (IP multicast address, APN) to the SGSN. The IP multicast address identifies the MBMS multicast service, which the UE wants to join/activate. An APN may indicate a specific GGSN.
7. The SGSN sends a MBMS Notification Response (Cause) to the GGSN that sent the MBMS Notification Request, where Cause shall indicate successful or unsuccessful MBMS context activation for the reason of SGSN or UE (Cause is FFS). Upon reception of the response message with Cause indicating unsuccessful operation or time-out of the MBMS Activation Timer in the GGSN, the GGSN may fallback to IP multicast access as defined in 3GPP TS 29.061 [4].
8. Security Functions may be performed, e.g. to authenticate the UE.
9. It is FFS whether the SGSN performs a subscription check for the requested MBMS multicast service identified by the IP multicast address and APN or whether another network entity performs this check. The SGSN creates an MBMS UE context and sends a Create MBMS Context Requests (IP multicast address, APN) to the GGSN.
10. The GGSN sends an MBMS Authorization Request seeking authorization for the activating UE to receive service data. The authorization decision is provided in the MBMS Authorization Response.11. If the GGSN does not have the MBMS Bearer Context information for this MBMS bearer service, the GGSN sends a MBMS Registration Request to the BM-SC. See subclause “MBMS Registration Procedure”.

If no TMGI has been allocated for this MBMS bearer service, the BM-SC will allocate a new TMGI. This TMGI will be passed to GGSN and SGSN via the MBMS Registration Response message and further to UE via Activate MBMS Context Accept message.

The BM-SC responds with a MBMS Registration Response containing the MBMS Bearer Context information for this MBMS bearer service and adds the identifier of the GGSN to the “list of downstream nodes” parameter in its MBMS Bearer Context. See subclause “MBMS Registration Procedure”.
12. The GGSN creates an MBMS UE context and sends a Create MBMS Context Response to the SGSN.
13. If the SGSN does not have the MBMS Bearer Context information for this MBMS bearer service, the SGSN sends a MBMS Registration Request to the GGSN. See subclause “MBMS Registration Procedure”.

The GGSN responds with a MBMS Registration Response containing the MBMS Bearer Context information for this MBMS bearer service and adds the identifier of the SGSN to the “list of downstream nodes” parameter in its MBMS Bearer Context. See subclause “MBMS Registration Procedure”.
14. The SGSN provides RAN with the MBMS UE Context(s) if at least one PS RAB is established for the UE..
15. The SGSN sends an Activate MBMS Context Accept to the UE. The SGSN does not need to wait for step 12 to be completed before sending this message.

### 8.3 MBMS Session Start Procedure

The BM-SC initiates the MBMS Session Start procedure when it is ready to send data. This is a request to activate all necessary resources in the network for the transfer of MBMS data and to notify interested UEs of the imminent start of the transmission.

Through this procedure, session attributes such as QoS, Multicast Area (tracking/non-tracking area are FFS) are provided to the GGSN(s) and SGSN(s) that have previously registered for the corresponding MBMS bearer service and to all RNCs that are connected to a registered SGSN. In addition the procedure allocates the bearer plane to all registered GGSNs and all registered SGSNs and to RNCs that respond to the session start accordingly.



The overall Session Start procedure is presented in the following figure:

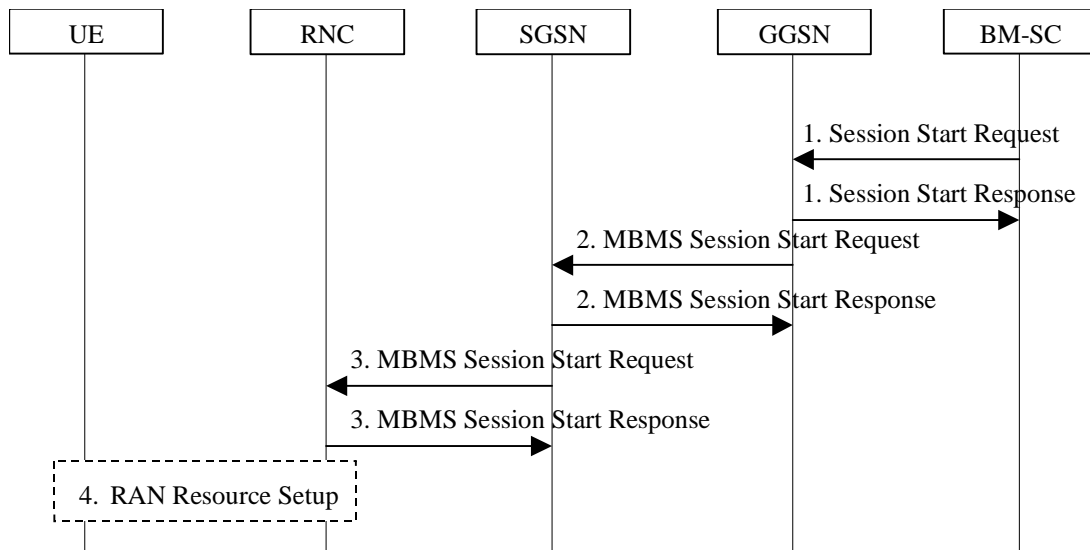

**Figure 8 Session Start procedure**

1. The BM-SC sends a Session Start Request message to indicate the impending start of the transmission and to provide the session attributes (QoS, Multicast Area...) to the GGSNs listed in the "list of downstream nodes" parameter of the corresponding MBMS Bearer Context. The BM-SC sets the state attribute of its MBMS Bearer Context to 'Active'. The GGSN stores the session attributes in the MBMS Bearer Context, sets the state attribute of its MBMS Bearer Context to 'Active' and sends a Session Start Response message to the BM-SC..
2. The GGSN sends an MBMS Session Start Request message to the SGSNs listed in the "list of downstream nodes" parameter of the corresponding MBMS Bearer Context. The SGSN stores the session attributes in the MBMS Bearer Context, sets the state attribute of its MBMS Bearer Context to 'Active' and responds with an MBMS Session Start Response message providing the TEID for bearer plane that the GGSN shall use for forwarding the MBMS data.
3. The SGSN sends an MBMS Session Start Request message including the session attributes to each RNC that is connected to this SGSN. The RNC responds with an MBMS Session Start Response to the SGSN. If the RNC serves the MBMS Service Area it stores the session attributes in the MBMS Service Context, sets the state attribute of its MBMS Service Context to 'Active' and responds with an MBMS Session Start Response message and the RNC includes the TEID in the MBMS Session Start Response message for the Iu bearer plane that the SGSN shall use for forwarding the MBMS data. An RNC receiving multiple MBMS Session Start Request messages includes Iu bearer plane parameters only into one MBMS Session Start Response message to establish only one Iu bearer plane to one SGSN.
4. The RNC establishes the necessary radio resources for the transfer of MBMS data to the interested UEs.

Note: The upstream node normally provides the MBMS Session Start Request message once per MBMS session to a downstream node. Due to "Intra Domain Connection of RAN Nodes to Multiple Core Network Nodes" however, an RNC may receive the MBMS Session Start Request message from several SGSNs.

## 8.4 MBMS Registration Procedure

The MBMS Registration is the procedure by which a downstream node informs an upstream node that it would like to receive session attributes and data for a particular MBMS service in order to distribute it further downstream. This procedure builds up a distribution tree for the delivery of MBMS session attributes and data from the BM-SC to the UEs interested in the service. This procedure results in the set-up of a corresponding MBMS Bearer Context in the

nodes along the distribution tree, but it does not result in the establishment of user plane which will be established by the Session Start procedure..

The MBMS Registration procedure is initiated:

- When the first MBMS UE Context for a particular MBMS service is created in the SGSN or GGSN (see subclause “MBMS UE Context”) and the corresponding MBMS Bearer Context is not already established in the node;
- When an MBMS Registration Request for a particular MBMS Service is received from a downstream node but the corresponding MBMS Bearer Context is not established in the node; or
- When a DRNC detects that it hosts UEs interested in the MBMS service (see subclause “RAN Resource Setup).

NOTE: The terms ‘downstream’ and ‘upstream’ refer to the topological position of one node with respect to another and relative to the direction of the MBMS data flow, i.e. from BM-SC to UE.

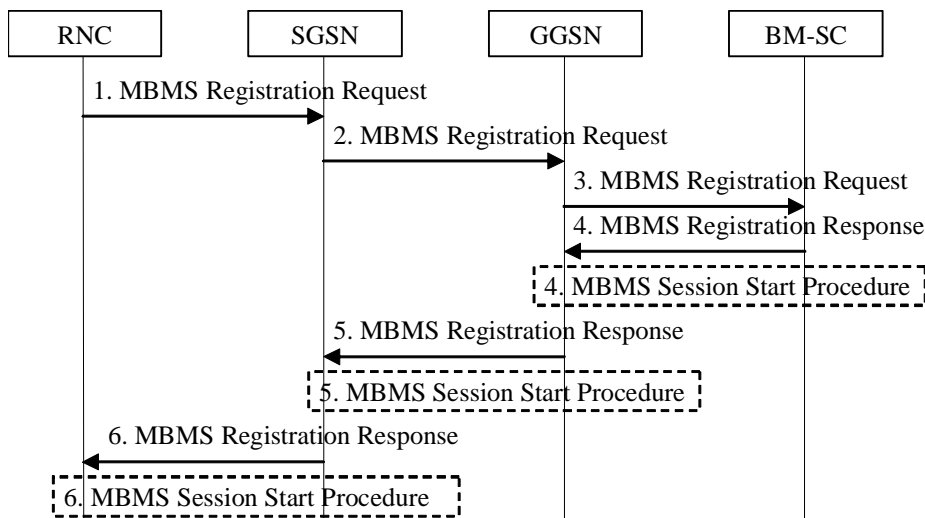

**Figure 9: MBMS Registration procedure**

1. When the DRNC detects that it hosts UEs interested in the MBMS Service , the DRNC sends a MBMS Registration Request message to its parent SGSN if not already done (see subclause “RAN Resource Setup”). How the RNC determines its parent SGSN is a matter of implementation.
2. If the SGSN has no MBMS Bearer Context for an MBMS Service and the SGSN receives an MBMS Registration Request from an RNC for this MBMS service, or if the first MBMS UE Context is created in the SGSN for an MBMS Service for which the SGSN has no corresponding MBMS Bearer Context, the SGSN creates an MBMS Bearer Context (in “Standby” state) and sends an MBMS Registration request (IP multicast address, APN,) message to the GGSN. How the SGSN selects a GGSN is a matter of implementation; it may for instance be based on prior signalling related to a particular UE or via APN resolution.
3. If the GGSN has no MBMS Bearer Context for an MBMS service and the GGSN receives an MBMS Registration from an SGSN for this MBMS service, or when the first MBMS UE Context is created in the GGSN for an MBMS service for which the GGSN has no MBMS Bearer Context , the GGSN sends a Registration Request (IP multicast address, APN) message to the BM-SC. The exact nature of the signalling between GGSN and BM-SC is however FFS in general.
4. Upon reception of an MBMS Registration Request from a GGSN, the BM-SC adds the identifier of the GGSN to the “list of downstream nodes” parameter in its MBMS Bearer Context and responds with a MBMS Registration Response message. The exact nature of the signalling between GGSN and BM-SC is however FFS in general. If the MBMS Bearer Context is in the ‘Active’ state, the BM-SC initiates the Session Start procedure with the GGSN, as described in Section 8.3.
5. If the GGSN receives a Registration Request from the SGSN in step 2, the GGSN:
  - adds the identifier of the SGSN to the “list of downstream nodes” parameter in its MBMS Bearer Context.

- responds with an MBMS Registration Response message, and
  - if the MBMS Bearer Context is in the 'Active' state, initiates the Session Start procedure with the SGSN, as described in Section 8.3.
6. If the SGSN received MBMS Registration Request from the DRNC in step 1, the SGSN:
- adds the identifier of the RNC to the "list of downstream nodes" parameter in its MBMS Bearer Context.
  - responds with an MBMS Registration Response message, and
  - if the MBMS Bearer Context is in the 'Active' state, initiates the Session Start procedure with the DRNC, as described in Section 8.3.

## 8.5 MBMS Session Stop Procedure

The BM-SC initiates the MBMS Session Stop procedure when it considers the session to be terminated. The session is typically terminated when there is no more MBMS data expected to be transmitted for a sufficiently long period of time to justify a release of user plane resources in the network. The procedure is propagated to all SGSNs and GGSNs that are registered for the corresponding MBMS bearer service and to RNCs that have an established Iu bearer plane with an SGSN..

The overall MBMS Session Stop procedure is presented in the following figure:

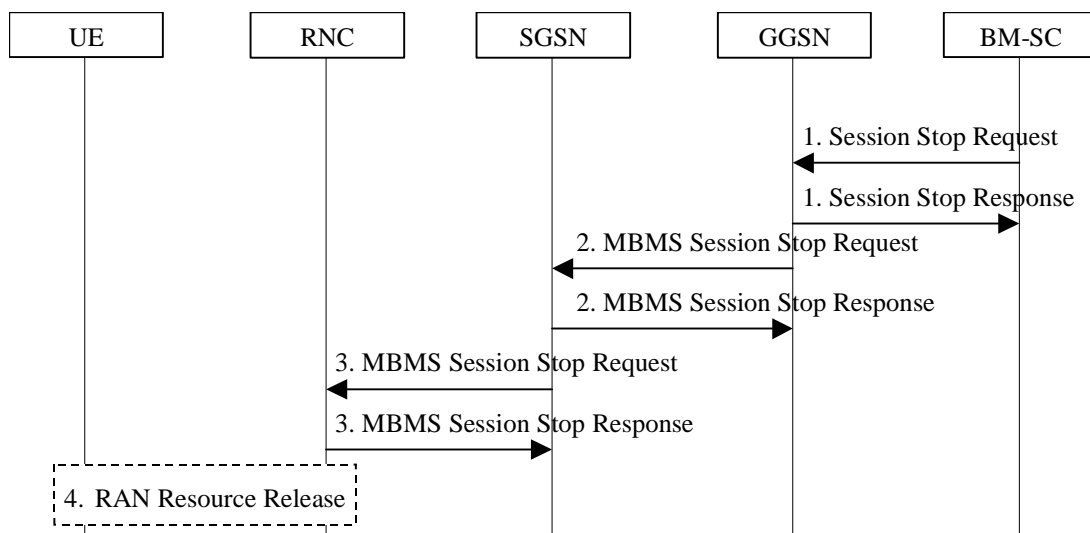

**Figure 10 MBMS Session Stop procedure**

1. The BM-SC sends a Session Stop Request message to all GGSNs listed in the "list of downstream nodes" parameter of the affected MBMS Bearer Context to indicate that the session is terminated and the bearer plane resources can be released. The BM-SC sets the state attribute of its MBMS Bearer Context to 'Standby'.
2. The GGSN sends an MBMS Session Stop Request message to all SGSNs listed in the "list of downstream nodes" parameter of the affected MBMS Bearer Context, releases the corresponding bearer plane resources towards these SGSNs and sets the state attribute of its MBMS Bearer Context to 'Standby'.
3. The SGSN releases the TEID and bearer plane resources on which it was receiving MBMS data from the GGSN for the affected MBMS bearer service and sends an MBMS Session Stop Request message to all RNCs that have a bearer plane established with the SGSN.
4. The RNC releases the affected radio and Iu resources.

## 8.6 MBMS De-Registration Procedure

The MBMS De-Registration is the procedure by which a downstream node informs an upstream node that it does not need a to receive signalling, session attributes and data for a particular MBMS bearer service anymore and therefore would like to be removed from the corresponding distribution tree.

The MBMS De-registration procedure is initiated:

- By the SGSN or GGSN when the last MBMS UE Context for a particular MBMS bearer service is deleted from the node and the “list of downstream nodes” parameter in the corresponding MBMS Bearer Context is empty;
- By the SGSN or GGSN when the last node registered in the “list of downstream nodes” de-registers from an MBMS bearer service for which there is no corresponding MBMS UE Context; or
- By the DRNC that registered at an SGSN when it deletes the associated MBMS Service Context.

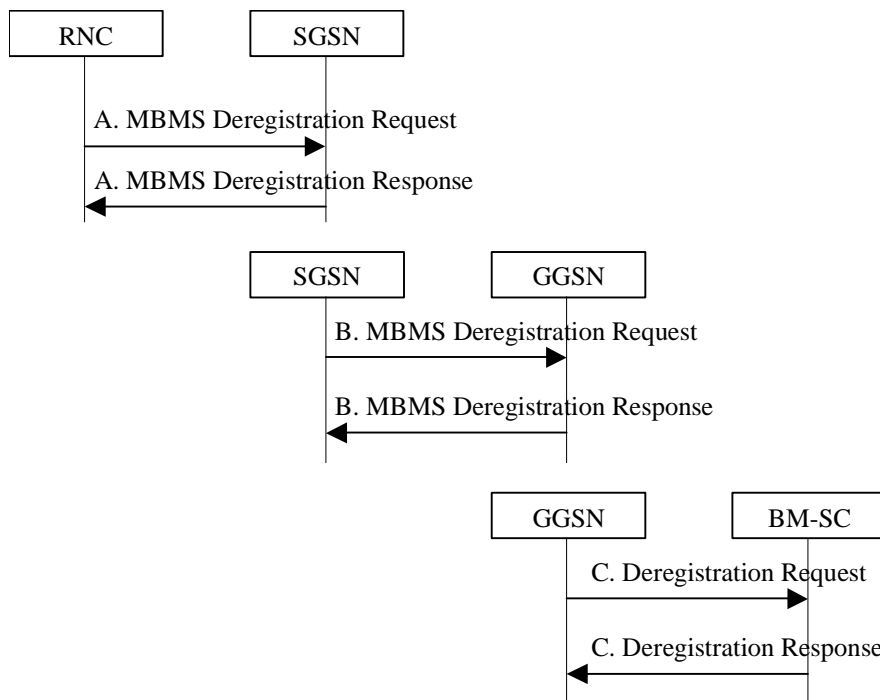

**Figure 11: MBMS De-Registration Procedure**

- A. When the DRNC that is registered at an SGSN no longer hosts any UE interested in that MBMS service, the DRNC requests the de-registration from the MBMS bearer service to its parent SGSN. As an implementation option, the RNC may decide not to de-register from the MBMS bearer service immediately when these conditions are met, e.g. in order to avoid unnecessary signalling in the case where the RNC would again need the same MBMS bearer service shortly after.

The SGSN removes the identifier of the RNC from the “list of downstream nodes” parameter of the affected MBMS Bearer Context and confirms the operation by sending an MBMS De-Registration Response message to the RNC. If an Iu bearer plane had been established between the RNC and the SGSN for this MBMS bearer service, the Iu bearer plane is released.

- B. When the “list of downstream nodes” of a particular MBMS Bearer Context in the SGSN becomes empty and the SGSN has no MBMS UE Contexts linked to that MBMS Bearer Context, the SGSN sends an MBMS De-Registration Request (IP multicast address, APN) message to its upstream GGSN.

The GGSN removes the identifier of the SGSN from the “list of downstream nodes” parameter of the affected MBMS Bearer Context and confirms the operation by sending an MBMS De-Registration Response message to the SGSN. . If a bearer plane had been established between the SGSN and the GGSN for this MBMS bearer service, the bearer plane is released.

- C. When the “list of downstream nodes” of a particular MBMS Bearer Context in the GGSN becomes empty and the GGSN has no MBMS UE Contexts linked to that MBMS Bearer Context, the GGSN sends a De-Registration Request (IP multicast address, APN) message to the BM-SC. The exact nature of the signalling between GGSN and BM-SC is however FFS in general. If a bearer plane had been established over Gi for this MBMS bearer service, the bearer plane is released.

The BM-SC removes the identifier of the GGSN from the “list of downstream nodes” parameter of the affected MBMS Bearer Context and confirms the operation by sending a De-Registration Response message to the GGSN.

### 8.6.1 BM-SC initiated MBMS De-Registration Procedure –

This MBMS De-Registration Procedure is initiated by BM-SC when the specific MBMS bearer service is terminated. This procedure tears down the distribution tree for the delivery of session attributes and MBMS data. This procedure results in releasing of all MBMS Bearer Contexts and associated MBMS UE Contexts in the nodes along the distribution tree.

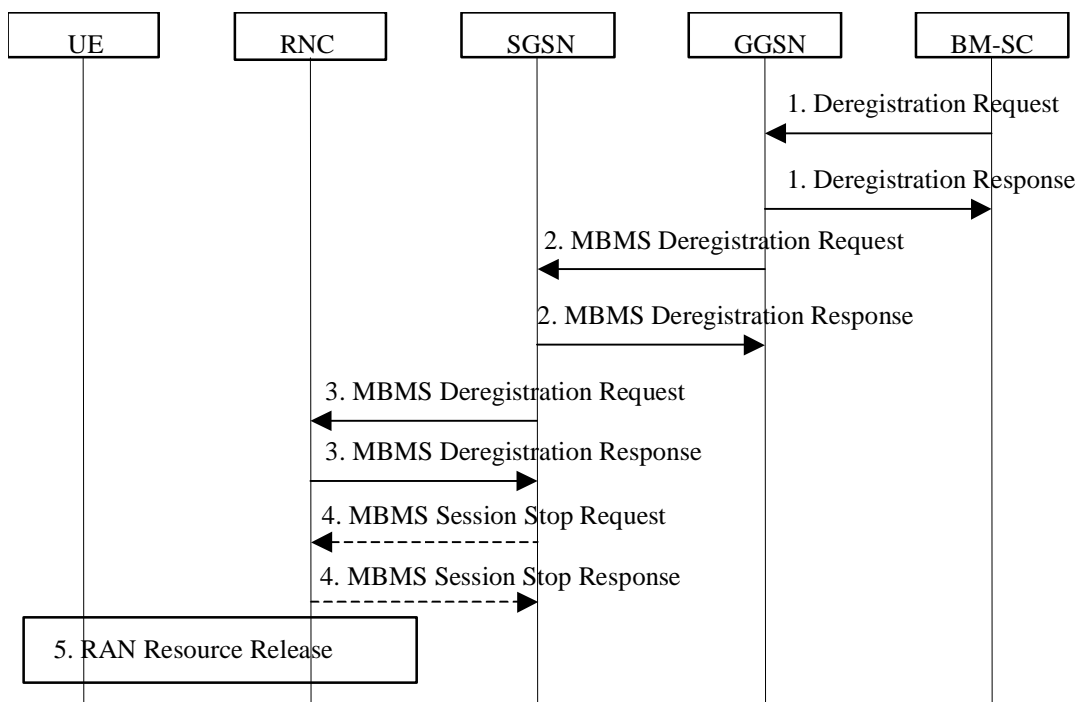

**Figure 12: BM-SC initiated MBMS De-Registration Procedure**

1. The BM-SC sends a De-Registration Request message to all GGSNs contained in the “list of downstream nodes” parameter of the corresponding MBMS Bearer Context to indicate the session is terminated and any related MBMS bearer resources shall be released.

The GGSN returns a De-Registration Response message to the BM-SC. The BM-SC releases all MBMS UE Contexts and removes the identifier of the GGSN from the “list of downstream nodes” parameter of the corresponding MBMS Bearer context.

2. The GGSN sends an MBMS De-Registration Request message to all SGSNs contained in the “list of downstream nodes” parameter. of the corresponding MBMS Bearer Context. The SGSN returns an MBMS De-registration Response message to the GGSN. The GGSN releases all MBMS UE Contexts and the affected MBMS Bearer Context. If a bearer plane had been established over Gi for this MBMS bearer service, the bearer plane is released.
3. The SGSN sends an MBMS De-Registration Request message to all RNCs listed in the “list of downstream nodes” parameter of the corresponding MBMS Bearer Context. The RNC returns an MBMS De-Registration Response message to the SGSN. The SGSN releases all MBMS UE Contexts and the affected MBMS Bearer Context. If a bearer plane had been established between the SGSN and the GGSN for this MBMS bearer service, the bearer plane is released.

- 4 If the state attribute of the MBMS Bearer Context is 'Active' the SGSN sends an MBMS Session Stop Request message to all RNCs that have a bearer plane established with the SGSN. The RNC releases all bearer resources and returns an MBMS Session Stop Response message to the SGSN.
5. The RNC releases the affected radio resources and the MBMS Service Context.. The detailed procedures are FFS depending on ongoing work in RAN groups. RAN may notify the UEs that the MBMS Bearer service has being terminated, so that the UE can locally deactivate its MBMS UE context, detailed procedures are FFS

## 8.7 MBMS Multicast Service Deactivation

The multicast service deactivation is a signalling procedure between the UE and the network. The procedure removes the MBMS UE Context from the UE, SGSN and GGSN for a particular MBMS multicast service. The multicast service deactivation can be initiated by:

- The UE;
- The BM-SC; or
- The SGSN

All these cases are contained in the procedure illustrated in Figure 13. The UE initiated Multicast Service Deactivation starts with step 1), the BM-SC initiated Multicast Service Deactivation starts with step 3) and the SGSN initiated Multicast Service Deactivation starts with step 5) or 8).

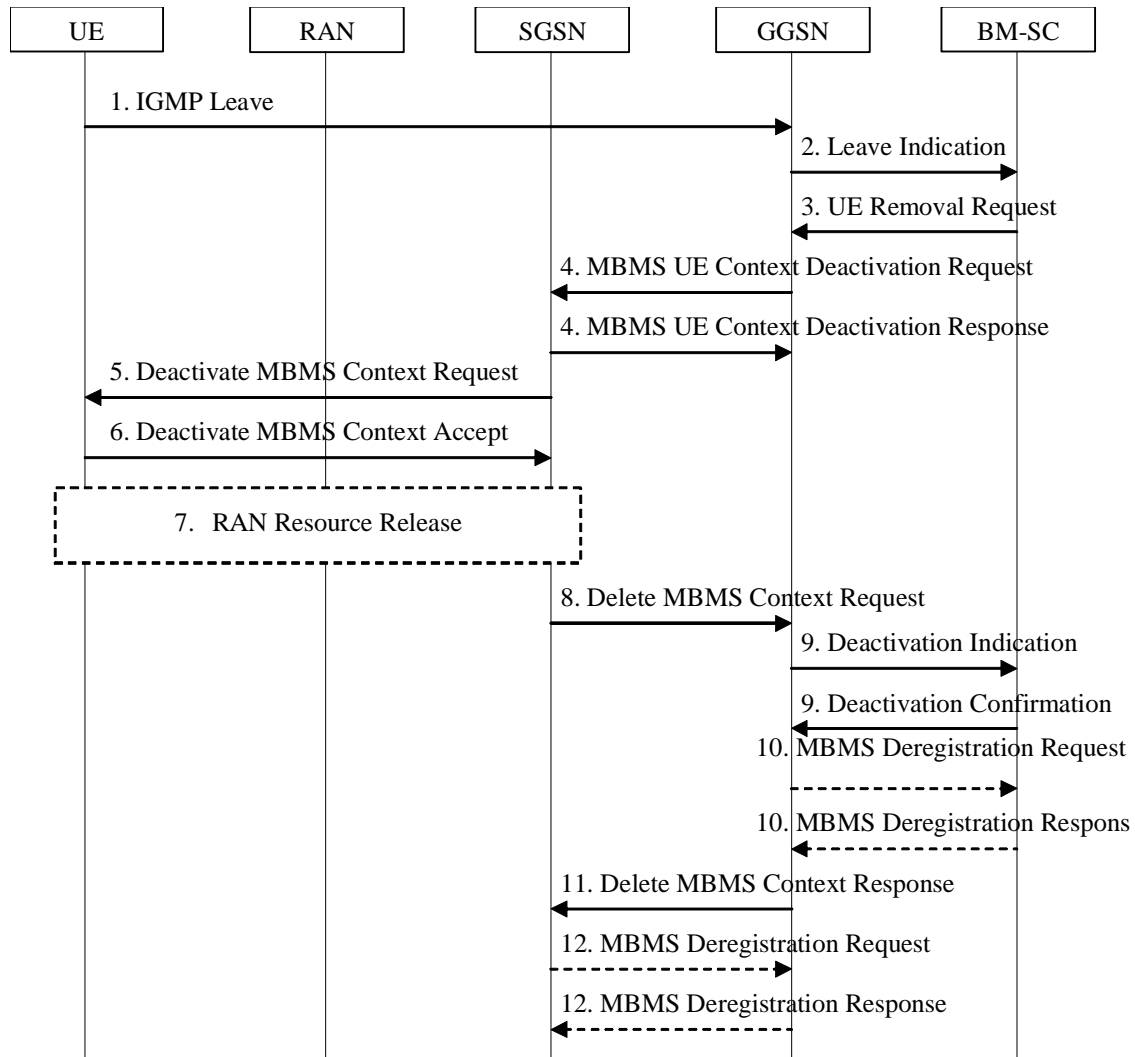

**Figure 13: MBMS Multicast Service Deactivation**

1. The UE sends an IGMP (IPv4) or MLD (IPv6) Leave message over the default PDP context to leave a particular multicast service identified by an IP multicast address.
2. The GGSN sends a Leave Indication (IP multicast address, IMSI) to the BM-SC, indicating that the UE is requesting to leave the multicast service identified by the IP multicast address. The exact nature of the signalling between GGSN and BM-SC is however FFS in general.
3. Upon reception of the Leave Indication, the BM-SC verifies that the IP multicast address corresponds to a valid MBMS service and sends a UE Removal Request (IP multicast address, APN, IMSI) to the GGSN that originated the Leave Indication. The APN shall be the same that was provided during service activation (see “MBMS Multicast Service Activation”). The exact nature of the signalling between GGSN and BM-SC is however FFS in general. The BM-SC may also initiate the deactivation of an MBMS UE Context for service-specific reasons (e.g. the service is terminated but the UE has not yet left the multicast group) by directly sending a UE Removal Request message to the GGSN.
4. The GGSN sends an MBMS UE Context Deactivation Request (IP multicast address, APN, IMSI) to the SGSN. The IP multicast address, APN and IMSI together identify the MBMS UE Context to be deleted by the SGSN. The APN is the one received in step 3. The SGSN acknowledges reception of the MBMS UE Context Deactivation Request by sending an MBMS UE Context Deactivation Response to the GGSN.
5. Upon reception of the MBMS UE Context Deactivation Request or for other reasons (e.g. due to a change in the roaming restrictions for the user) the SGSN sends a Deactivate MBMS Context Request (TI) to the UE. The TI identifies the MBMS UE Context to be deleted by the UE.
6. The UE deletes the MBMS UE Context and sends a Deactivate MBMS Context Accept (TI) to the SGSN.

7. If dedicated radio resources are currently assigned to the UE for the reception of the MBMS data, the RAN releases these radio resources. If shared radio resources are currently assigned for the distribution of the MBMS data, the RAN may decide to move the remaining UEs to dedicated resources. The detailed procedures and conditions are FFS depending on ongoing work in RAN groups.
8. Upon reception of the Deactivate MBMS Context Accept or for other reasons (e.g. due to missing periodic updates) the SGSN sends a Delete MBMS Context Request (NSAPI) to the GGSN that holds the MBMS UE Context.
9. The GGSN deletes the MBMS UE Context and sends a Deactivation Indication to the BM-SC to confirm the successful deactivation of the MBMS UE Context. The BM-SC, after receiving the Deactivation Indication, deletes the MBMS UE Context and sends a confirmation to the GGSN. The exact nature of the signalling between GGSN and BM-SC is however FFS in general.
10. If the GGSN does not have any more users interested in this MBMS multicast service and the “list of downstream nodes” in the corresponding MBMS Bearer Context is empty, the GGSN sends a MBMS De-Registration Request to the BM-SC. The BM-SC responds with a MBMS De-Registration Response and removes the identifier of the GGSN from the “list of downstream nodes” parameter in its MBMS Bearer Context. See subclause “MBMS De-Registration Procedure”.
11. The GGSN confirms the deactivation of the MBMS UE Context to the SGSN by sending a Delete MBMS Context Response to the SGSN, which then deletes the MBMS UE Context.
12. If the SGSN does not have any more users interested in this MBMS multicast service and the “list of downstream nodes” in the corresponding MBMS Bearer Context is empty, the SGSN sends an MBMS De-Registration Request to the GGSN. The GGSN responds with an MBMS De-Registration Response and removes the identifier of the SGSN from the “list of downstream nodes” parameter in its MBMS Bearer Context. See subclause “MBMS De-Registration Procedure”.

## 8.8 Iu Bearer Plane release procedure

A RNC triggers the Iu Bearer Plane release procedure if the RNC has no further use for the user plane (i.e. no UEs left in the coverage area of the RNC or session stop) (hysteresis mechanisms can be used in the RNC to avoid continuous Bearer plane establishments and releases).

## 8.9 RAN Resource Setup

**Editor’s note:** The content of this subclause is dependent on ongoing work in RAN groups. The main focus of this section should be on the externally observable behaviour of the RAN (as seen from the Iu interface) and aspects that have direct impact on CN procedures. This subclause should in particular describe which of the SRNC, DRNC or CRNC is responsible for MBMS data distribution depending on whether ptp or ptm distribution has been selected.]

## 8.10 Inter SGSN Routeing Area Update

This procedure is performed when a UE with active MBMS service performs a Routeing Area Update and the serving SGSN changes. It bases on the Inter SGSN Routeing Area Update procedure specified in TS 23.060. The procedure is performed regardless whether MBMS sessions are ongoing or not. The handling of any PDP contexts established by the UE is not changed compared to the procedure without MBMS. The procedure described below does not show all details of the Routeing Area update procedure. Only for the MBMS specific additions the steps are described.



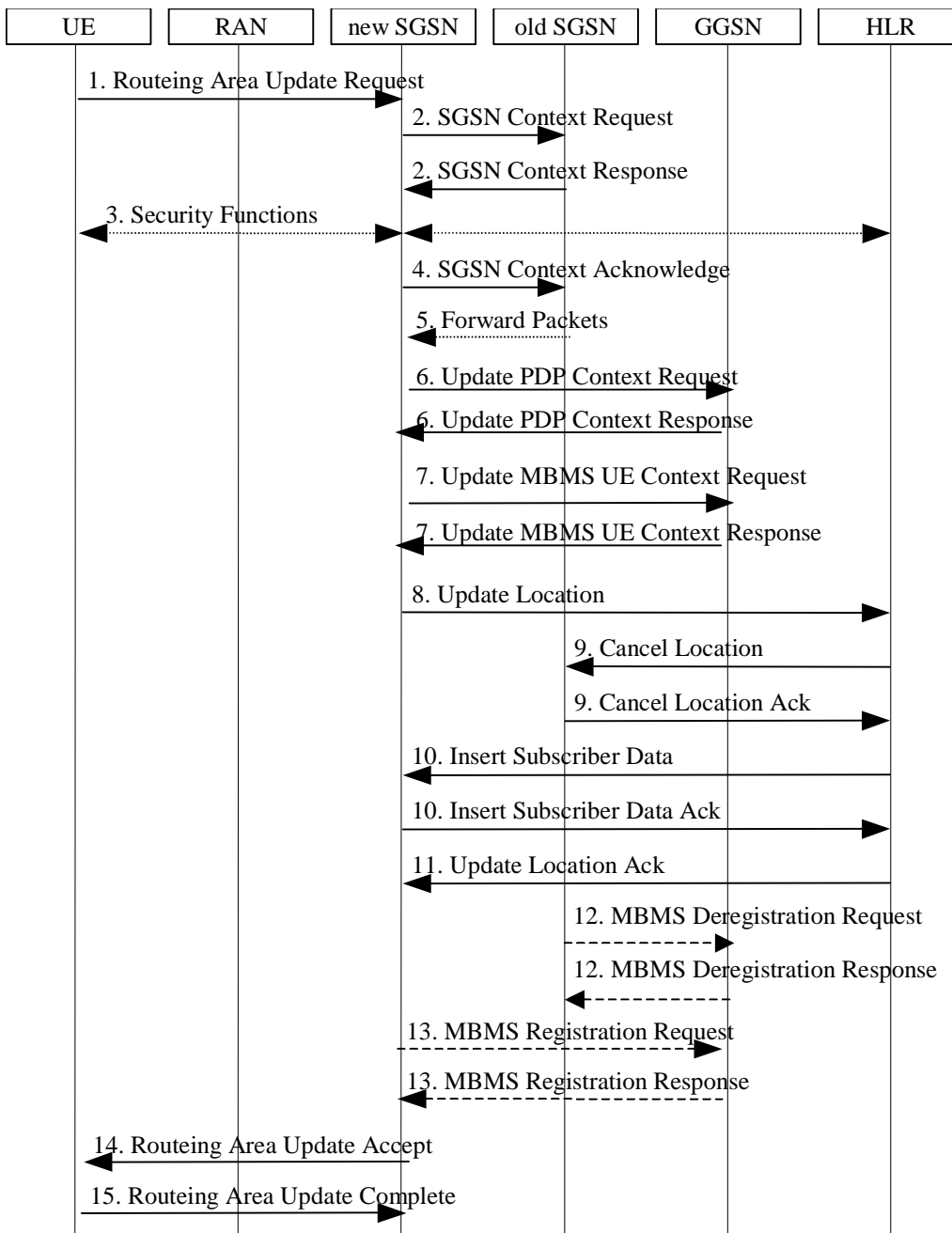

**Figure 14. Inter SGSN Routing Area Update**

- 2) The context transfer in step 2 includes the transfer of the MBMS UE Context(s).
- 7) The new SGSN sends Update MBMS UE Context Request to the GGSNs concerned. The GGSNs update their MBMS UE Context fields and return Update MBMS UE Context Response.
- 12) If the old SGSN does not have any more MBMS UE Contexts for the MBMS multicast service(s) and the “list of downstream nodes” in the corresponding MBMS Bearer Context is empty, the SGSN sends an MBMS Deregistration Request to the GGSN. The GGSN responds with an MBMS Deregistration Response and removes the identifier of the SGSN from the “list of downstream nodes” parameter in its MBMS Bearer Context. See subclause “MBMS Deregistration Procedure”.
- 13) The new SGSN verifies for each MBMS UE Context received whether it has a corresponding MBMS Bearer Context. For each MBMS Bearer Context the SGSN does not already have the SGSN creates an MBMS Bearer Context (in “Standby” state) and sends an MBMS Registration Request to a GGSN. This registration is described in subclause “MBMS Registration Procedure”.

## 8.11 Inter SGSN Serving RNS Relocation Procedure

This procedure is performed when the SGSN changes due to SRNS relocation. It bases on the SRNS Relocation procedure specified in TS 23.060. The procedure is performed regardless whether MBMS sessions are ongoing or not. The handling of any PDP contexts established by the UE is not changed compared to the procedure without MBMS. The procedure described below does not show all details of the SRNS relocation procedure. Only for the MBMS specific additions the steps are described.

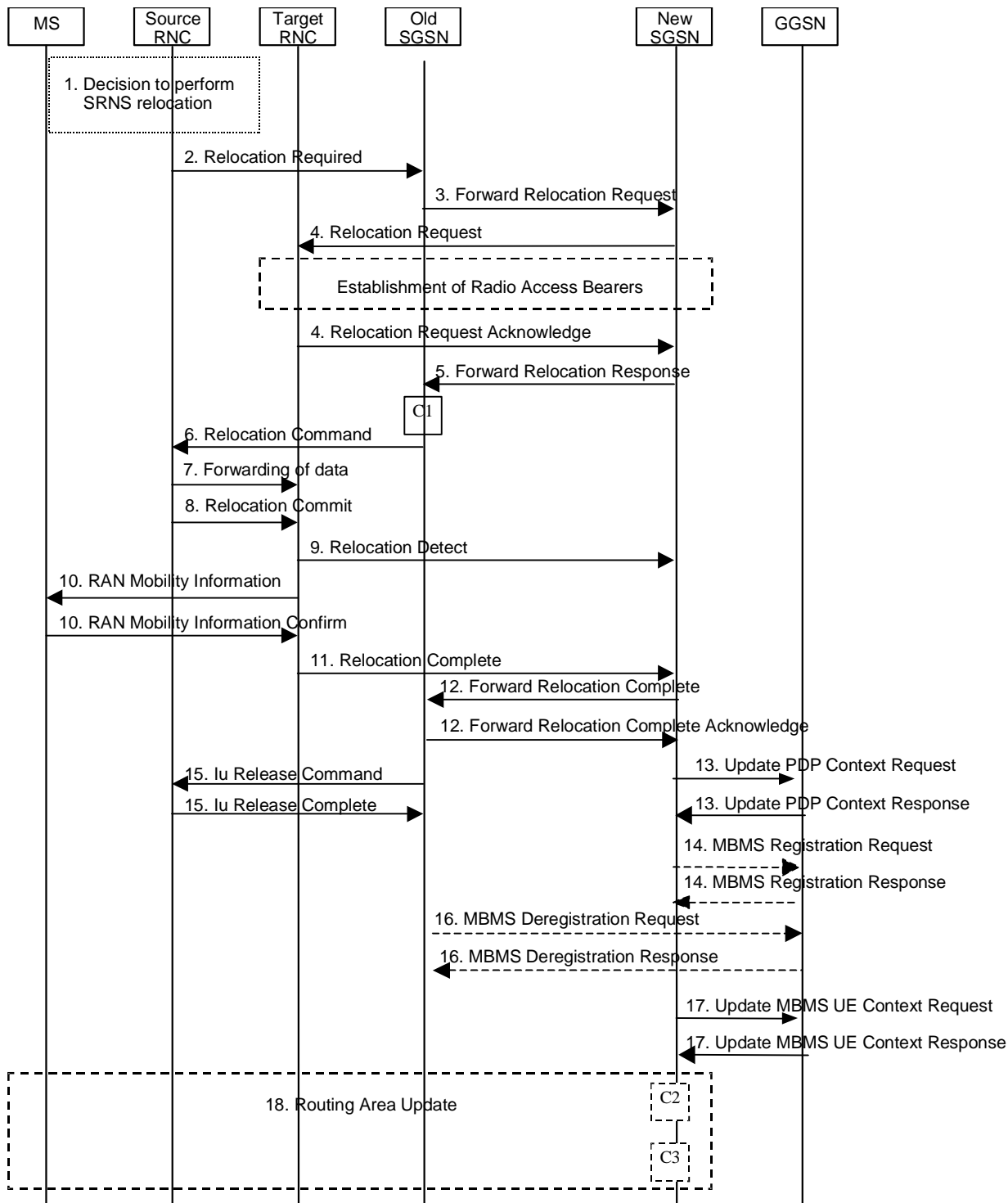

Figure 15: SRNS Relocation Procedure

3) The context transfer in step 3 includes the transfer of the MBMS UE Context(s).

- 14) The new SGSN verifies for each MBMS UE Context received whether it has a corresponding MBMS Bearer Context. For each MBMS Bearer Context not yet existing in the SGSN the SGSN creates an MBMS Bearer Context (in “Standby” state) and sends an MBMS Registration Request to a GGSN. This registration is described in subclause “MBMS Registration Procedure”.
- 16) If the old SGSN does not have any more MBMS UE Contexts for this MBMS multicast service and the “list of downstream nodes” in the corresponding MBMS Bearer Context is empty, the SGSN sends an MBMS De-registration Request to the GGSN. The GGSN responds with an MBMS De-registration Response and removes the identifier of the SGSN from the “list of downstream nodes” parameter in its MBMS Bearer Context. See subclause “MBMS De-registration Procedure”.
- 17) The new SGSN sends Update MBMS UE Context Request to the GGSNs concerned. The GGSNs update their MBMS UE Context fields and return Update MBMS UE Context Response.

## 8.12 MBMS Broadcast Service Activation

MBMS Broadcast service activation is the procedure by which a UE locally activates a broadcast service:

- The broadcast activation procedure does not register the user in the network. There is no MBMS specific signaling exchanged between the UE and the Network
- The broadcast activation procedure does not establish MBMS UE contexts in UE, SGSN and GGSN.

## 8.13 MBMS Broadcast service de-activation

The MBMS Broadcast service de-activation by the UE is local to the UE, i.e. without interaction with the Network.

## 8.14 MBMS Broadcast Session Start Procedure

The BM-SC initiates the MBMS Session Start procedure when it is ready to send data. This is a request to activate all necessary resources in the network for the transfer of MBMS data. It is FFS whether it is also used to notify interested UEs of the start of the transmission.

Through this procedure, session attributes such as QoS, Broadcast Area (tracking/non-tracking area are FFS) are provided to all the GGSN(s), SGSN(s) and RNCs. In addition the procedure allocates the bearer plane to all GGSNs and all SGSNs and to RNCs that respond to the session start accordingly.

The overall Broadcast Session Start procedure is presented in the following figure:

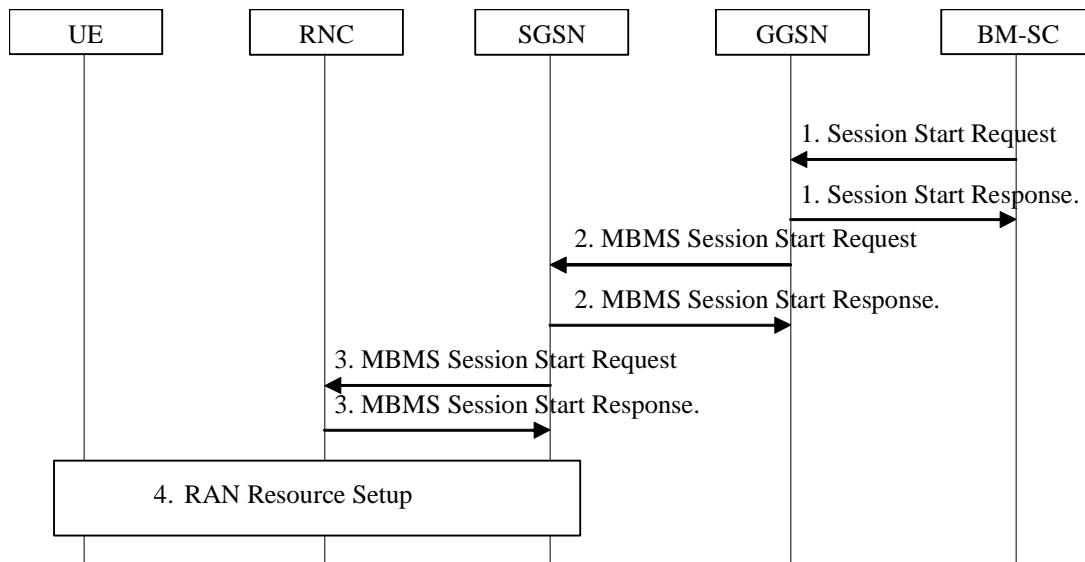

**Figure 16 Session Start procedure for MBMS Broadcast Service**

- 1) The BM-SC sends a Session Start Request message the impending start of the transmission and to provide the session attributes (QoS, Broadcast Area...) to a GGSNs of the PLMN. The BM-SC sets the state attribute of its MBMS Bearer Context to 'Active'. The GGSN creates a MBMS Bearer Context, stores the session attributes, sets the state attribute of this MBMS Bearer Context to 'Active' and sends a Session Start Response message to the BM-SC.
- 2) The GGSN sends an MBMS Session Start Request message to all its SGSNs. The SGSN creates a MBMS Bearer Context, stores the session attributes, sets the state attribute of this MBMS Bearer Context to 'Active' and responds with an MBMS Session Start Response message providing the TEID for bearer plane that the GGSN shall use for forwarding the MBMS data.
- 3) The SGSN sends an MBMS Session Start Request message including the session attributes to each RNCs that is connected to this SGSN. The RNC responds with an MBMS Session Start Response message to the SGSN. If the RNC serves the MBMS Broadcast Area, it creates a MBMS Bearer Context, stores the session attributes in this MBMS Service Context, sets the state attribute of its MBMS Service Context to 'Active' and responds with an MBMS Session Start Response message, and the RNC includes the TEID in the MBMS Session Start Response message for the Iu bearer plane that the SGSN shall use for forwarding the MBMS data. An RNC receiving multiple MBMS Session Start Request messages from different SGSNs includes Iu bearer plane parameters only into one MBMS Session Start Response message to establish only one Iu bearer plane to one SGSN.
- 4) The RNC establishes the necessary radio resources for the transfer of MBMS data to the interested UEs.

Note: The upstream node normally provides the MBMS Session Start Request message once per MBMS session to a downstream node. Due to "Intra Domain Connection of RAN Nodes to Multiple Core Network Nodes" however, an RNC may receive the MBMS Session Start Request message from several SGSNs.

## 9 Security

- A SIM or USIM shall be present in the UE to receive MBMS multicast services.
- MBMS multicast data transmission to the UEs shall be secured.
- MBMS security shall be provided by encryption and integrity protection between the UE and the BM-SC.
- The BM-SC shall be able to authenticate and authorize each MBMS content provider.

- The integrity of MBMS data received from the content provider shall be guaranteed.

---

## 10 Charging requirement

MBMS architecture shall support on-line and off-line charging.

It shall be possible to collect charging information for the multicast mode. It shall also be possible to collect charging information for MBMS services in visited networks.

MBMS shall collect charging information about the transmission of MBMS broadcast or multicast data that are provided by content or service providers (e.g. 3<sup>rd</sup> parties). This shall enable billing of broadcast and multicast content or service providers.

To enable billing of broadcast and multicast content providers, data shall be collected at the BM-SC.

**NOTE:** SGSN, GGSN and BM-SC generate charging data for the transmitted data, always under the assumption that the UEs are within the MBMS service area. If the Multicast area is less than the PLMN, then there is the possibility that a UE will have moved outside the Multicast area. Charging data will still be generated for that UE causing an inaccuracy in the data. This inaccuracy increases as the size of the Multicast area is decreased.

---

## Annex A (Informative): Information flows

### A.1 General information flow

---

## Annex B

### Change history

*It is usual to include an annex (usually the final annex of the document) for reports under TSG change control which details the change history of the report using a table as follows:*

Change history							
Date	TSG #	TSG Doc.	CR	Rev	Subject/Comment	Old	New
2002-06					First Version		0.0.0
2002-09					Output from SA2 #27, inclusion of S2-023072		0.1.0
2002-11					Output from SA2 #28, inclusion of S2-023591, S2-023592, S2-023593, S2-023594, S2-023595, S2-023596 +S2-022967 From SA2#17	0.1.0	0.2.0
2002-12					Addition of official TS number	0.2.0	0.2.1
2003-02					Output from SA2#29 and e-mail approval: S2-030382, S2-030284, S2-030385rev4, S2-030386r1, S2-030387	0.2.1	0.3.0
2003-02					Output from SA#30, inclusion of S2-030626, S2-030647 an S2-030651	0.3.0	0.4.0
2003-04					Output from SA2#31, inclusion of S2-031236, S2-031238, S2-031237r2	0.4.0	0.5.0
					Output from SA2#32, inclusion of S2-031843, S2-031844, S2-031845, S2-031849, S2-031850, S2-032118, S2-032119	0.5.0	0.6.0
					Presentation to SA for information	0.6.0	1.0.0
					Output from SA2#33, inclusion of S2-031231, S2-032410, S2-032412, S2-032417, S2-032419, S2-032425,S2-032426	1.0.0	1.1.0
2003-08					Output from SA2#34, inclusion of S2-032889, S2-032894, S2-032896, S2-032898, S2-032904, S2-033143, S2-033144, S2-033145, S2-033147, S2-033148, S2-033149, S2-033150	1.1.0	1.2.0
2003-08					Editorial correction (S2-033148 was incorrectly added) + Other Minor editorials (change bars from V 1.2.0 still retained)	1.2.0	1.2.1
2003-09					Presentation to SA for Approval	1.2.1	2.0.0