

**3GPP TSG SA #6
Nice, FRANCE
15th - 17th December 1999**

Tdoc TSG SA SP-99591

Source: TSG SA WG3

Subject: TS 3G 33.107

Agenda item: 5.3.3

This document contains TS 3G 33.107 version 1.0.0 agreed by SA WG3 to be presented to SA#6 for information and approval. The presentation sheet is in SP-99592_annex_a.doc. The result from the joint meeting S3 LI and SMG10 WPD in Vienna (01-03 Dec. 1999) is now the stable version of the specification.

SUBJECT	WG_DOC	3G_PHASE
3G Security; Lawful Interception Architecture and Functions	S3-99508	99

3G TS 33.107 V1.0.0 (1999-12)

Technical Specification

**3rd Generation Partnership Project;
Technical Specification Group Services and Systems Aspects;
3G Security;
Lawful Interception Architecture and Functions
(3G TS 33.107 version 1.0.0)**



Reference

DTS/TSG<SA 3>-0<WG 3><33.106 v2.0.0> U

Keywords

<keyword[Security, Lawful, Legal, Interception]>

3GPP

Postal address

3GPP support office address

650 Route des Lucioles - Sophia Antipolis
Valbonne - FRANCE
Tel.: +33 4 92 94 42 00 Fax: +33 4 93 65 47 16

Internet

<http://www.3gpp.org>

Copyright Notification

No part may be reproduced except as authorised by written permission.
The copyright and the foregoing restrictions extend to reproduction in all media.

© 3GPP 1999
All rights reserved

Contents

Introduction.....	6
1 Scope.....	7
2 References	7
3 Definitions, symbols and abbreviations.....	7
3.1 Definitions	7
3.2 Symbols	Error! Bookmark not defined.
3.3 Abbreviations.....	7
4 Functional architecture	9
5 Activation, deactivation and interrogation	10
5.1 Activation	11
5.1.1 X1_1-interface	11
5.1.2 X1_2-interface (IRI).....	12
5.1.3 X1_3-interface (CC).....	13
5.2 Deactivation.....	13
5.2.1 X1_1-interface	13
5.2.2 X1_2-interface (IRI).....	14
5.2.3 X1_3-interface (CC).....	14
5.3 Interrogation	15
5.3.1 Interrogation of the 3G MSC and 3G GSN.....	15
5.3.2 Interrogation of Delivery Functions	15
6 Invocation of Lawful Interception for Circuit Switched Services.....	16
6.1 Provision of Intercept Product - Circuit Switched	16
6.1.1 Delivery configuration to the LEMF.....	17
6.1.2 X3-interface	18
6.2 Provision of CC - Short Message Service.....	18
6.3 Provision of Intercept Related Information.....	18
6.3.1 X2-interface	19
6.3.2 Structure of the events.....	19
6.3.3 Call Related events.....	21
6.3.4 Non Call Related events.....	23
6.4 Intercept cases for circuit switched supplementary services	24
6.4.1 Interception of Multiparty call	24
6.4.2 Interception for Call Forwarding / Call Deflection / ECT.....	25
7 Invocation of Lawful Interception for Packet Data services	26
7.1 Provision of Intercept Product - Short Message Service.....	27
7.2 Provision of Intercepted Content of Communications – Packet data services	27
7.2.1 X3p-interface	28
7.3 Provision of Intercept Related Information.....	28
7.3.1 X2p-interface	29
7.3.2 Structure of the events.....	29
7.4 Packet Data related events.....	30
7.5 Intercept cases for supplementary services	33
8 Security.....	33
8.1 Administration security	33
8.2 IRI security.....	33
8.3 CC security.....	34
8.4 Security aspects of Lawful Interception billing.....	34
8.5 Other security issues.....	34

3G Security Lawful Interception Requirements**5**

Annex A (informative): Information flows for Lawful Interception invocation of circuit switched services	35
A.1 Mobile originated circuit switched calls	35
A.2 Mobile terminated circuit switched calls.....	36
A.3 Call hold / call waiting.....	37
A.4 Multiparty calls.....	38
A.5 Call forwarding / call deflection.....	41
A.5.1 Unconditional call forwarding	41
A.5.2 Call forwarding on not reachable (IMSI detached).....	41
A.5.3 Call forwarding on busy (network determined)	42
A.5.4 Call forwarding on not reachable (no response to paging/radio channel failure).....	42
A.5.5 Call forwarding on no reply	43
A.5.6 Call forwarding on busy (user determined)/call deflection	43
A.5.7 Call waiting / call forwarding on no reply	44
A.6 Explicit call transfer	46
B Information flows for Lawful Interception invocation of Packet Data services (informative)	48
B.1 Mobile Station Attach.....	48
B.2 Mobile Initiated Mobile Station Detach.....	48
B.3 Network initiated Mobile Station Detach	50
B.4 Intra 3G GSN Routing Area Update	50
B.5 Inter 3G GSN Routing Area Update	52
B.6 PDP Context Activation.....	53
B.7 Start of interception with PDP context active	53
B.8 MS initiated PDP Context Deactivation	53
B.9 Network initiated PDP Context Deactivation	54
B.10 SMS	54
History.....	56

Foreword

This Technical Specification has been produced by the 3GPP SA WG3.

The contents of the present document are subject to continuing work within the TSG and may change following formal TSG approval.

Introduction

This Technical Specification has been produced by the 3GPP TSG SA to allow for the standardisation in the area of lawful interception of telecommunications. This document describes in general the architecture and functions for lawful interception. Laws of individual nations and regional institutions (e.g. European Union), and sometimes licensing and operating conditions define a need to intercept telecommunications traffic and related information in modern telecommunications systems. It has to be noted that lawful interception shall always be done in accordance with the applicable national or regional laws and technical regulations.

1 Scope

The present document describes the architecture and functional requirements within a Third Generation Mobile Communication System (3GMS).

The specification shows the service requirements from a Law Enforcement point of view only. The aim of this document is to define a 3GMS interception system that supports a number of regional interception regulations, but these regulations are not repeated here as they vary. Regional interception requirements shall be met in using specific (regional) mediation functions allowing only required information to be transported.

2 References

- [1] **ETR 331**: Definition of User Requirements for Lawful Interception of Telecommunications Requirements of the Law Enforcement Agencies
 - [2] **ES 201 158**: Lawful Interception; Requirements for network functions
 - [3] **ES 201 671**: Handover Interface for the lawful interception of telecommunications traffic
 - [4] **GSM 01.33**: Lawful Interception requirements for GSM
 - [5] **GSM 02.33**: Lawful Interception - stage 1
 - [6] **GSM 03.33**: Lawful Interception - stage 2
 - [7] **3G TS 33.106** 3GPP Lawful Interception Requirements
 - [8] **J-STD-25** Interim Standard, Lawfully Authorised Electronic Surveillance
-

3 Definitions, symbols and abbreviations

3.1 Definitions

For the purposes of the present document, the following terms and definitions apply.

Network Based Interception: Interception that is invoked at a network access point regardless of Target Identity.

Subject Based Interception: Interception that is invoked using a specific Target Identity

Target Identity: A technical identity that uniquely identifies a target of interception. One target may have one or several identities.

Interception Area: is a subset of the network service area comprised of a set of cells which defines a geographical zone.

Location Dependent Interception: is interception of a target mobile within a network service area that is restricted to one or several Interception Areas (IA).

3.2 Abbreviations

For the purposes of the present document, the following abbreviations apply:

3GMS	3 rd Generation Mobile Communication System
3G GGSN	3 rd Generation Gateway GPRS Support Node
3G GSN	3 rd Generation GPRS Support Node (GGSN/SGSN)
3G MSC	3 rd Generation Mobile Switching Center
3G SGSN	3 rd Generation Serving GPRS Support Node
3G UMSC	3 rd Generation Unified Mobile Switching Centre
ADMF	Administration Function
CC	Content of Communication

3G Security Lawful Interception Requirements**8**

CGI	Cell Global Identity
DF	Delivery Function
ECT	Explicit Call Transfer
GPRS	General Packet Radio Service
HI	Handover Interface
IA	Interception Area
IP	Internet Protocol
IRI	Intercept Related Information
LDI	Location Dependent Interception
LEA	Law Enforcement Agency
LEMF	Law Enforcement Monitoring Facility
RA	Routing Area

4 Functional architecture

The following picture contains the reference configuration for the lawful interception. The various entities and interfaces are described in more detail in the succeeding subclauses.

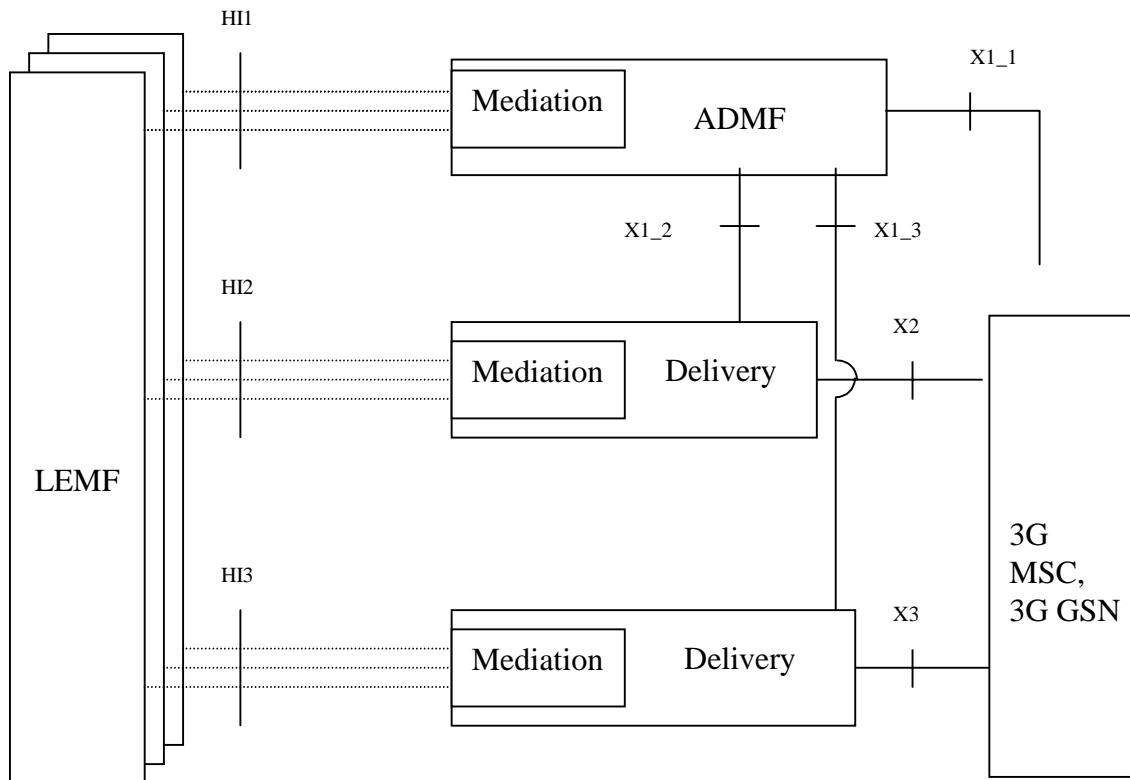

Figure 1: Reference configuration

The reference configuration is only a logical representation of the entities involved in lawful interception and does not mandate separate physical entities. This allows for higher levels of integration.

Regional Mediation Functions, which may be transparent or part of the administration and delivery functions, are used to convert information on the HI1, HI2 and HI3 interfaces in the format described in various national or regional specifications. For example, if ES 201 671 or J-STD-25 is used, then the adaptation to HI1, HI2 and HI3 will be as defined in those specifications

There is one Administration Function (ADMF) in the network. Together with the delivery functions it is used to hide from the 3G MSC and 3G GSN that there might be multiple activations by different Law Enforcement Agencies (LEAs) on the same target. The administration function may be partitioned to ensure separation of the provisioning data from different agencies.

The HI2 and HI3-interfaces represent the interfaces between the LEA and two delivery functions. The delivery functions are used:

3G Security Lawful Interception Requirements

10

- to distribute the Intercept Related Information (IRI) to the relevant LEA(s) via HI2 (based on IAs, if defined);
- to distribute the Content of Communication (CC) to the relevant LEA(s) via HI3 (based on IAs, if defined).

See the remaining sections of this document for definitions of the X1_1, X1_2, X1_3, X2 and X3 interfaces.

Interception at the Gateways is a national option.

5 Activation, deactivation and interrogation

Figure 2 is an extraction from the reference intercept configuration shown in figure 1 which is relevant for activation, deactivation and interrogation of the lawful interception.

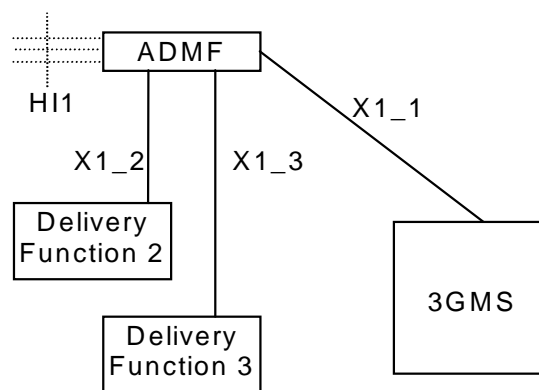

Figure 2: Functional model for Lawful Interception activation, deactivation and interrogation

In addition to the typical 3G MSC and 3G GSN functional entities, a new functional entity is introduced - the ADMF - the Lawful Interception administration function. The ADMF:

- interfaces with all the LEAs that may require interception in the intercepting network;
- keeps the intercept activities of individual LEAs separate;
- interfaces to the intercepting network.

Every physical 3G MSC and 3G GSN is linked by an own X1_1-interface to the ADMF. Consequently, every single 3G MSC and 3G GSN performs interception (activation, deactivation, interrogation as well as invocation) independently from other 3G MSCs and 3G GSNs. The HI1-interface represents the interface between the requester of the lawful interception and the Lawful administration function; it is included for completeness, but is beyond the scope of standardisation in this document.

The target identities for 3GMS interception can be at least on of the following: IMSI, MSISDN or IMEI.

In case of location dependent interception the following network/national options exist:

3G Security Lawful Interception Requirements

11

- target location versus Interception Areas (IAs) check in the 3G MSC , 3G SGSN, and Delivery Functions (DFs);
- target location versus IAs check in the DFs (physical collocation of the DFs to the 3G MSC and 3G GSN may be required by national law).

NOTE 1: The IA is previously defined by a set of cells. From the location of the target this set of cells permits to find the relevant IA.

NOTE 2: It is not required that the 3G GMSC or the 3G GGSN are used for interception when Location Dependent Interception is invoked and the location of the target is not available.

5.1 Activation

Figures 3,4 and 5 show the information flow for the activation of Lawful Interception.

5.1.1 X1_1-interface

The messages sent from the ADMF to the 3G MSC and 3G GSN (X1_1-interface) contain the:

- target identities (MSISDN, IMSI or IMEI) (see note 4);
- information whether the Content of Communication (CC) shall be provided (see note 1);
- information whether the Intercept Related Information (IRI) shall be provided (see note 1);
- address of Delivery Function 2 (DF2) for the intercept related information (see note 2);
- address of Delivery Function 3 (DF3) for the intercepted content of communications (see note 3);
- IA in case of location dependent interception.

NOTE 1: As an option, the filtering whether intercept product and/or intercept related information has to be provided can be part of the delivery functions. If the option is used, the corresponding information can be omitted on the X1_1-interface, while "information not present" means "intercept product and related information has to be provided" for the SN. Furthermore the delivery function which is not requested has to be "pseudo-activated", in order to prevent error cases at invocation.

NOTE 2: As an option, only a single DF2 is used by and known to every 3G MSC and 3G GSN. In this case the address of DF2 can be omitted.

NOTE 3: As an option, only a single DF3 is used by and known to every 3G MSC and 3G GSN. In this case the address of DF3 can be omitted.

NOTE 4: Since the IMEI is not available, interception of IMEI is not applicable at the 3G Gateway.

If after activation subsequently Content of Communications (CC) or Intercept Related Information (IRI) has to be activated (or deactivated) an "activation change request" with the same identity of the target is to be sent.

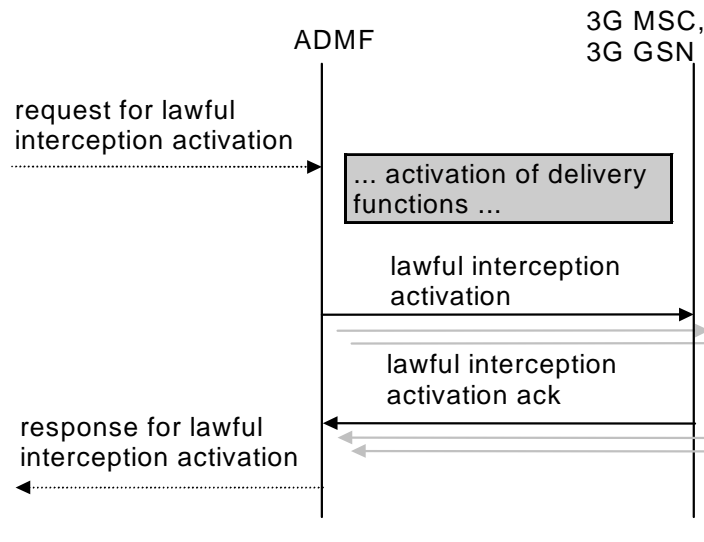

Figure 3: Information flow on X1_1-interface for Lawful Interception activation

Interception of a target can be activated on request from different LEAs and each LEA may request interception via a different identity. In this case, each target identity on which to intercept will need to be sent via separate activation messages from ADMF to the 3G MSC and 3G GSN on the X1_1-interface. Each activation can be for CC only, IRI only, or both CC and IRI.

When several LEAs request activation on the same identity then the ADMF determines that there are existing activations on the identity. In this case, the ADMF will not send an additional activation message to the 3G MSC and 3G GSN except when the activation needs to change from CC only or IRI only to CC and IRI. In that case an activation change message will be sent to the 3G MSC and 3G GSN.

5.1.2 X1_2-interface (IRI)

For the activation of IRI the message sent from the ADMF to the DF contains:

- the target identity;
- the address for delivery of IRI (= LEMF address);
- which subset of information shall be delivered;
- a DF2 activation identity, which uniquely identifies the activation for DF2 and is used for further interrogation or deactivation, respectively;
- the IA in case of location dependent interception;
- the warrant reference number if required by national option.

If a target is intercepted for several LEAs and/or several identities simultaneously, a single activation of delivery is necessary for each combination of LEA and identity.

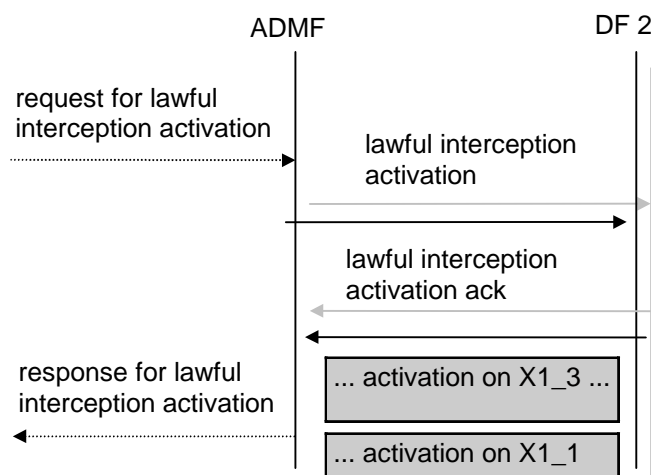

Figure 4: Information flow on X1_2-interface for Lawful Interception activation

5.1.3 X1_3-interface (CC)

For the activation of intercepted Content of Communications the message sent from the ADMF to the Delivery Function contains:

- the target identity;
- the address of delivery for CC (= LEMF address);
- a DF3 activation identity, which uniquely identifies the activation for DF3 and is used for further interrogation or deactivation, respectively;
- the IA in case of location dependent interception;
- the warrant reference number if required by national option.

If a target is intercepted by several LEAs and/or several identities simultaneously, a single activation of delivery is necessary for each combination of LEA and identity.

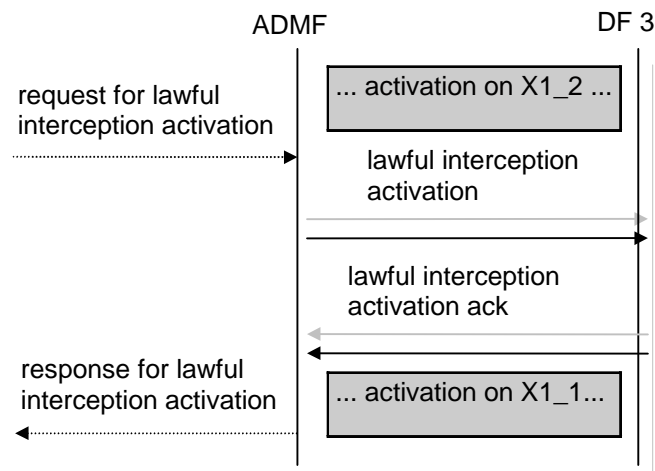

Figure 5: Information flow on X1_3-interface for Lawful Interception activation

5.2 Deactivation

Figures 6,7 and 8 show the information flow for the deactivation of the Lawful interception.

5.2.1 X1_1-interface

The messages sent from the ADMF to the 3G MSC and 3G GSN for deactivation contain:

- the target identity;
- the possible relevant IAs in case of location dependent interception.

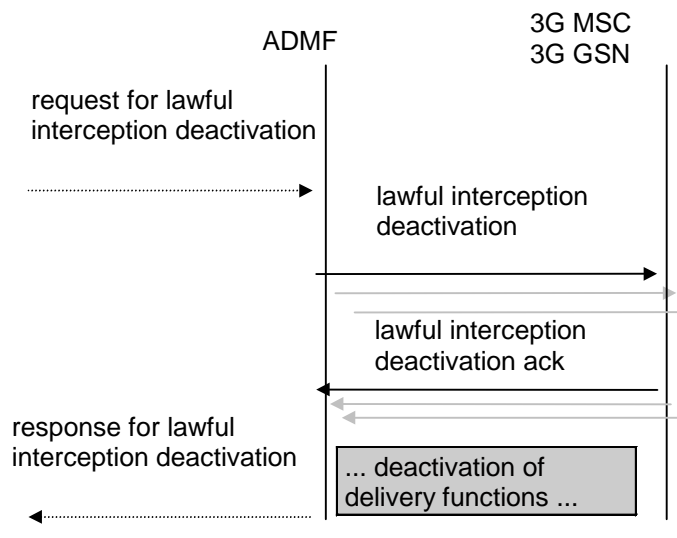

Figure 6: Information flow on X1_1-interface for Lawful Interception deactivation

3G Security Lawful Interception Requirements

14

If interception of a target has been activated via different identities then a separate deactivation message will need to be sent from the ADMF to the 3G MSC and 3G GSN for each identity. When several LEAs requested activation on the same identity and subsequently request deactivation then the ADMF determines that there are remaining activations on the identity. In this case, the ADMF will not send a deactivation message to the 3G MSC and 3G GSN except when the activation needs to change from CC and IRI to CC only or IRI only. In that case an activation change message will be sent to the 3G MSC and 3G GSN.

5.2.2 X1_2-interface (IRI)

The messages sent from the ADMF to Delivery Function 2 for the deactivation of the Intercept Related Information contain:

- a DF2 activation id, which uniquely identifies the activation to be deactivated for DF2.

If a target is intercepted by several LEAs and/or several identities simultaneously, a single deactivation is necessary for each combination of LEA and identity.

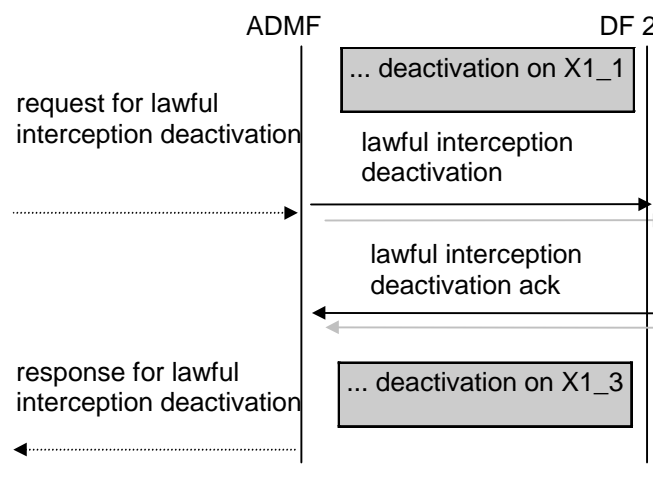

Figure 7: Information flow on X1_2-interface for Lawful Interception deactivation

5.2.3 X1_3-interface (CC)

For the deactivating the delivery of the CC the messages from the ADMF to DF3 contain:

- a DF3 activation id, which uniquely identifies the activation to be deactivated for DF3.

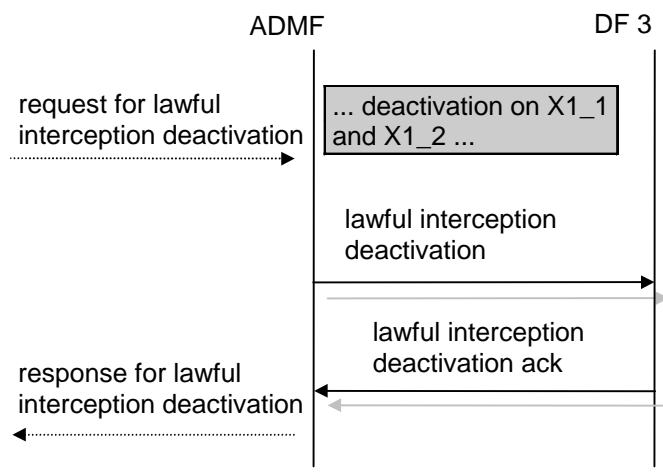

Figure 8: Information flow on X1_3-interface for Lawful Interception deactivation

5.3 Interrogation

Interrogation provides the current status of the interception activation in the system. Interrogation of all activations for a given LEA is an ADMF function.

5.3.1 Interrogation of the 3G MSC and 3G GSN

Figure 9 shows the information flow for the interrogation of the Lawful Interception. It shall be possible to interrogate

- a specific activation at each relevant 3G MSC and 3G GSN;
- all activations at each relevant 3G MSC and 3G GSN.

As result of the interrogation the activation status and data are returned.

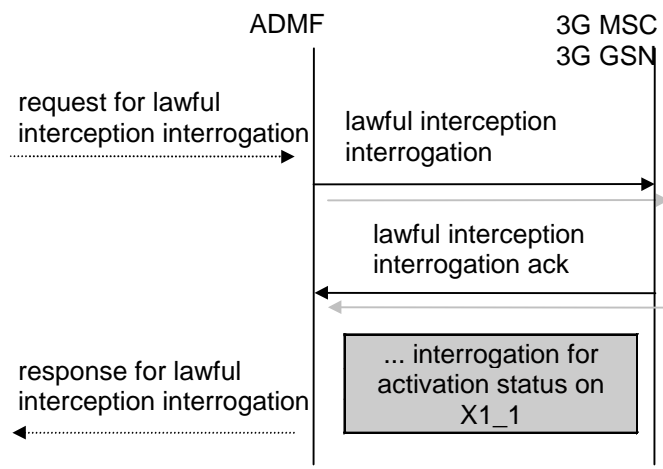

Figure 9: Interrogation of the Lawful Interception (3G MSC and 3G GSN)

5.3.2 Interrogation of Delivery Functions

Figure 10 shows the information flow for the interrogation of the Lawful Interception. It shall be possible to interrogate:

- a specific activation at a DF;
- all activations at a DF for a given target identity;
- all activations at a DF.

As result of the interrogation the activation status and data are returned.

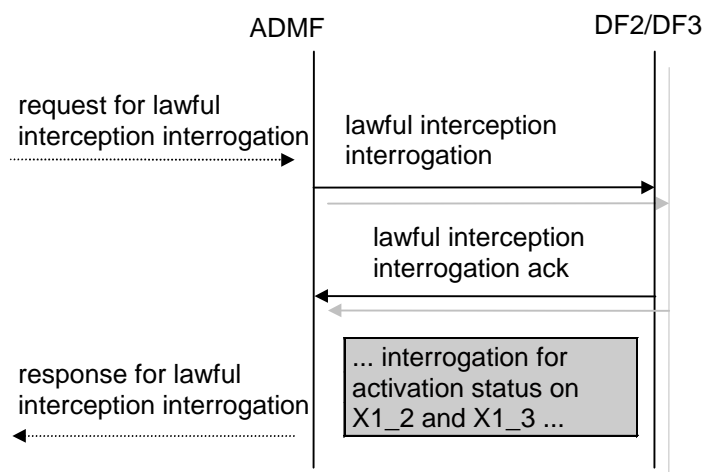

Figure 10: Interrogation of the Lawful Interception (Delivery Functions)

6 Invocation of Lawful Interception for Circuit Switched Services

Figure 11 shows an extraction from the reference configuration in figure 1 which is relevant for the invocation of the lawful interception.

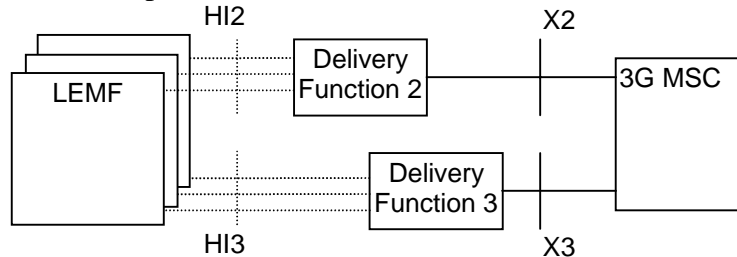

Figure 11: Functional model for Lawful Interception invocation

The HI2 and HI3 interfaces represent the interfaces between the LEMF and two delivery functions. Both interfaces are subject to national requirements. They are included for completeness, but are beyond the scope of standardization in this document. The delivery functions are used:

- to convert the information on the X2-interface to the corresponding information on the HI2-interface;
- to convert the information on the X3-interface to the corresponding information on the HI3-interface;
- to distribute the intercept related information to the relevant LEA(s) (based on IAs, if defined);
- to distribute the intercept product to the relevant LEA(s) (based on IAs, if defined).

In case a call is selected based on several identities (MSISDN, IMSI, IMEI) of the same target, the 3G MSC will deliver CC and IRI only once to the DF2 and DF3. DF2 and DF3 will then distribute the information to the relevant LEA that requested interception on a particular target identity.

For the delivery of the CC and IRI, the 3G MSC provides a correlation number and target identity to the DF2 and DF3 which is used there in order to select the different LEAs to which the product shall be delivered.

NOTE: If interception has been activated for both parties of the call both CC and IRI will be delivered for each party as separate intercept activity.

For Location Dependent Interception, the location dependency check occurs at the establishment of each call. Subsequent dependency checks for simultaneous calls are not required, but can be a national option.

If a target is marked using an IA in the 3G MSC, the 3G MSC shall perform a location dependency check at call set-up. Only if the target's location matches the IA is call the intercepted.

If a target is marked using an IA in the DF2, the DF2 shall perform a location dependency check at reception of the first IRI for the call. Only if the target's location matches the IA for certain LEAs is IRI the relayed to these LEAs. All subsequent IRIs for the call are sent to the same LEAs.

If a target is marked using an IA in the DF3, the DF3 shall perform a location dependency check at reception of the CC. Only if the target's location matches the IA for certain LEAs is the CC relayed to these LEAs.

6.1 Provision of Intercept Product - Circuit Switched

Figure 12 shows the access method for the delivering of CC shall be bridged/ T-connection (see figure 12).

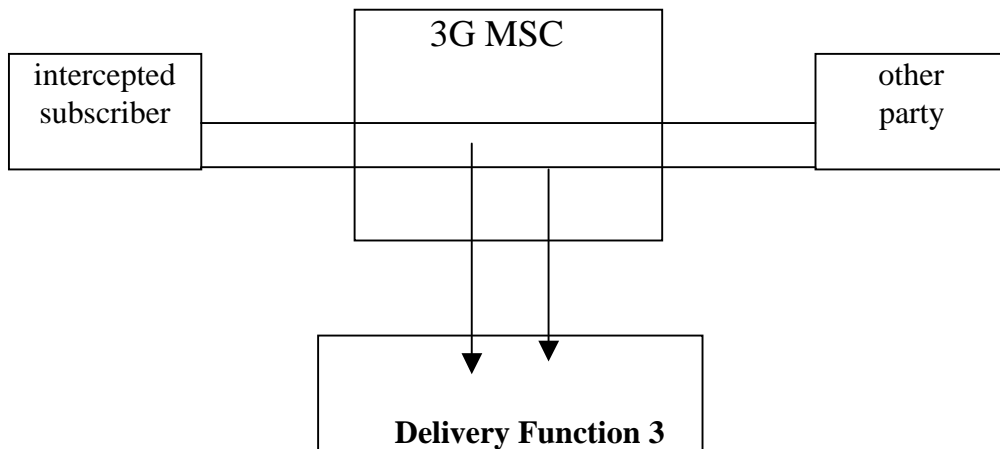

Figure 12: Bridged Access

6.1.1 Delivery configuration to the LEMF

Figure 13 shows the configuration for circuit switched calls. The signals of both parties of the configuration to be intercepted are delivered separately to the requesting function. The requesting function itself has no impact on the connection between the subscribers.

The two stublines towards the LEMF are established in parallel to the call set up. For both stublines the address is used which has been provided during activation.

NOTE: For data calls it is necessary to provide means for fast call establishment towards the LEMF so that it doesn't miss the beginning of the data transmission.

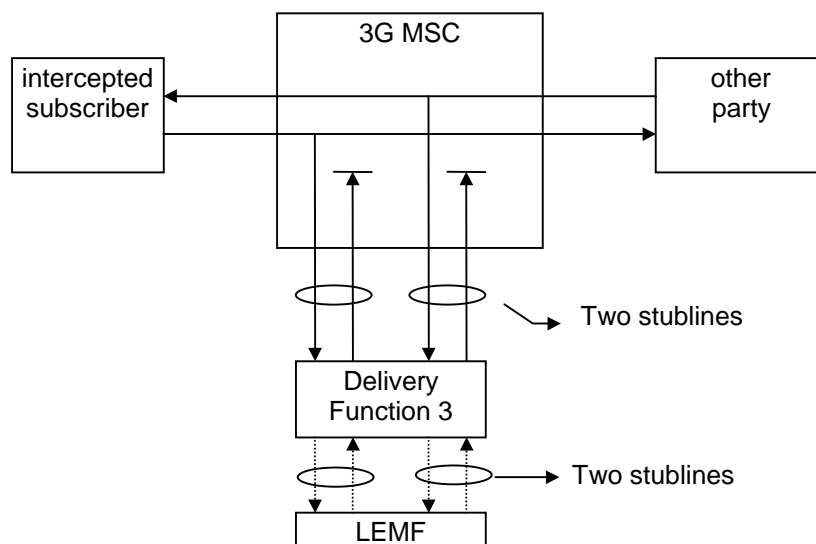

Figure 13: Delivery configuration to the LEMF for the interception of a circuit switched call

6.1.2 X3-interface

The following information needs to be transferred from the 3G MSC to the DF3 in order to allow the DF3 to perform its functionality:

- target identity (MSISDN, IMSI or IMEI);
- signal indicator (Signal from target or signal to target)
- the target location (if available) or the IAs in case of location dependent interception.

Additional information may be provided as national option.

6.2 Provision of CC - Short Message Service

Figure 14 shows an SMS transfer from the 3G MSC to the LEMF. Quasi-parallel to the delivery from / to the mobile subscriber a message, which contains the contents of the SMS with the header, is generated and sent via the Delivery Function 2 to the LEMF in the same way as the Intercept Related Information.

The IRI will be delivered to the LEMF:

- for a SMS-MO, when the SMS-Centre receives the SMS;
- for a SMS-MT, when the MS receives the SMS.

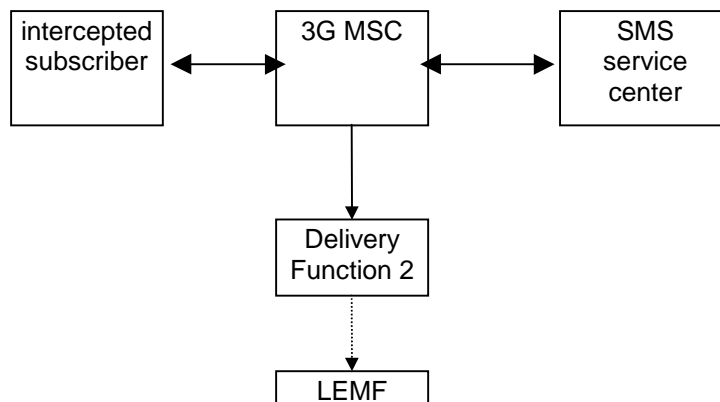

Figure 14: Provision of Content of Communication - Short Message Service

6.3 Provision of Intercept Related Information

Intercept Related Information (Events) are necessary at the Begin and End of the call, for all supplementary services during a call and for information which is not call associated. There are call related events and non call related events

Figure 15 shows the transfer of intercept related information to the DF2. If an event for / from a mobile subscriber occurs, the 3G MSC sends the relevant data to the DF2.

3G Security Lawful Interception Requirements

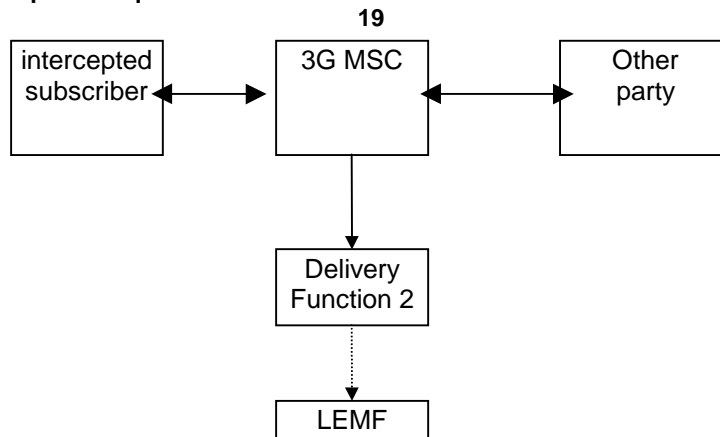

Figure 15: Provision of Intercept Related Information

6.3.1 X2-interface

The following information needs to be transferred from the 3G MSC to the DF2 in order to allow a DF2 to perform its functionality:

- target identity (MSISDN, IMSI or IMEI);
- in case of location dependent interception, the IAs and/or target cell ID shall be provided.
- events and associated parameters as defined in subclauses 6.3.3 and 6.3.4 may be provided.

6.3.2 Structure of the events

The information sent to DF2 is triggered by up to eight different call related and non-call related events. Details are described in following subclause. The events for interception are configurable (if they are sent to DF2) in the 3G MSC and can be suppressed in the DF2. The events are listed as follows:

Call Related Events:

- Call Establishment
- Answer
- Supplementary Service
- Handover
- Release

Non Call Related Events:

- SMS
- Location Update
- Subscriber Controlled Input

Table 1 below shows the set of information that is used to generate the events. The events transmit the information from the 3G MSC to DF2. This set of information can be extended in the 3G MSC, if this is necessary in a specific country. DF2 can extend this information if this is necessary in a specific country e.g. a unique number for each surveillance warrant.

Observed MSISDN Target Identifier with the MSISDN of the target subscriber (monitored subscriber).
Observed IMSI Target Identifier with the IMSI of the target subscriber (monitored subscriber).
Observed IMEI

3G Security Lawful Interception Requirements

20

Target Identifier with the IMEI of the target subscriber (monitored subscriber), It shall be checked for each call over the radio interface
event type Description which type of event is delivered: Establishment, Answer, Supplementary service, Handover, Release, SMS, Location update, Subscriber controlled input
event date Date of the event generation in the 3G MSC
event time Time of the event generation in the 3G MSC
dialled number Dialled phone number before digit modification, IN-modification etc.
Connected number Number of the answering party
other party address Directory number of the other party for MOC Calling party for MTC
call direction Information if the monitored subscriber is calling or called e.g. MOC/MTC or originating/ terminating In or/out
Correlation number Unique number for each call sent to the DF, to help the LEA, to have a correlation between each Call and the IRI
cell id Cell number of the target; for the location information
Location area code Location-area-code of the target defines the Location Area in a PLMN
basic service Information about Tele service or bearer service.
Supplementary service Supplementary services used by the target e.g. CF, CW, ECT
Forwarded to number Forwarded to number at CF
call release reason Call release reason of the target call
SMS Message The SMS content with header which is sent with the SMS-service
Redirecting number The number which invokes the call forwarding towards the target. This is provided if available.
SCI Non call related Subscriber Controlled Input (SCI) which the 3G MSC receives from the ME

Table 1 Information Elements for Circuit Event records

6.3.3 Call Related events

6.3.3.1 Call establishment

For call establishment a call establishment-event is generated. This event is generated at the beginning of a call when the 3G MSC attempts to reach the subscriber. This information will be delivered to the DF2 if available:

Observed MSISDN
Observed IMSI
Observed IMEI
event type
event date
event time
dialled number
other party address
call direction
Correlation number
Redirecting number
cell id
Location area code
basic service
Supplementary service

6.3.3.2 Answer

If the called party answers, an answer- event is generated. This information will be delivered to the DF2 if available:

Observed MSISDN
Observed IMSI
Observed IMEI
event type
event date
event time
dialled number
other party address
Connected party
call direction
Correlation number
Redirecting number
cell id
Location area code
basic service
Supplementary service

3G Security Lawful Interception Requirements

22

6.3.3.3 Supplementary Services

For supplementary services events are generated with the information which supplementary service is used e.g. Call Forwarding (CF), Call Waiting (CW), Explicit Call Transfer (ECT), Multi Party (MPTY), Call Hold and information correlated to the service like the forwarded to number. This information will be delivered to the DF2 if available:

Observed MSISDN
Observed IMSI
Observed IMEI
event type
event date
event time
dialled number
other party address
call direction
Correlation number
cell id
Location area code
basic service
Supplementary service
Forwarded to number

6.3.3.4 Handover

For each handover due to a target Cell ID change, a handover-event with the information about the new cell ID is generated. This information will be delivered to the DF2 if available:

Observed MSISDN
Observed IMSI
Observed IMEI
event type
event date
event time
Correlation number
cell id
Location area code

3G Security Lawful Interception Requirements

23

6.3.3.5 Release

For the release or failed attempt of a target call, a release event with the following information is generated. This information will be delivered to the DF2 if available:

Observed MSISDN
Observed IMSI
Observed IMEI
event type
event date
event time
dialled number
other party address
call direction
Correlation number
cell id
Location area code
basic service
call release reason

6.3.4 Non Call Related events

6.3.4.1 SMS

For MO-SMS the event is generated in the 3G MSC, when the SMSC successfully receives the SMS; for MT-SMS the event is generated in the 3G MSC when the target receives the message. This information will be delivered to the DF2 if available:

Observed MSISDN
Observed IMSI
event type
event date
event time
cell id
Location area code
SMS Message

6.3.4.2 Location update

For location updates a Location update-event is generated, with the new location (location area) information. This information will be delivered to the DF2 if available:

Observed MSISDN
observed IMSI
event type
event date
event time
cell id
location area code

6.3.4.3 Subscriber Controlled Input (SCI)

SCI includes subscriber initiated changes in service activation and deactivation. SCI does not include any information available in the CC. For subscriber controlled inputs - a SCI-event is

3G Security Lawful Interception Requirements

24

generated with information about the SCI. This information will be delivered to the DF2 if available:

observed MSISDN
observed IMSI
event type
event date
event time
cell id
location area code
SCI

6.4 Intercept cases for circuit switched supplementary services

6.4.1 Interception of Multiparty call

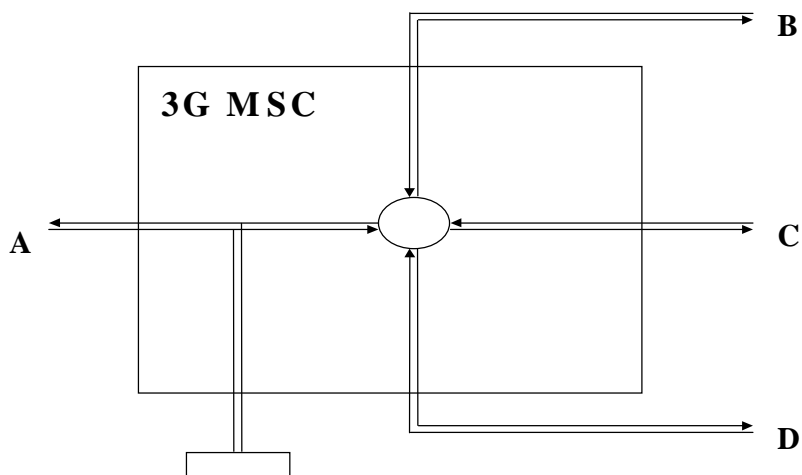

Figure 16: Interception of Multiparty for CC

Figure 16 shows the delivery of CC from intercepted multiparty call where party A is the target of interception.

One pair of call content channels are delivered to the delivery function. Party A is delivered to the DF3 on one channel and the sum of the balance of the parties, B,C and D is delivered on the second channel.

It should be noted that if parties B,C or D is a target of interception, that intercept is treated as a simple call intercept.

The events contain information about B, C and D if subscriber A is monitored. If one of B, C or D is monitored, events contain the information about A but not the other parties of the conference.

6.4.2 Interception for Call Forwarding / Call Deflection / ECT

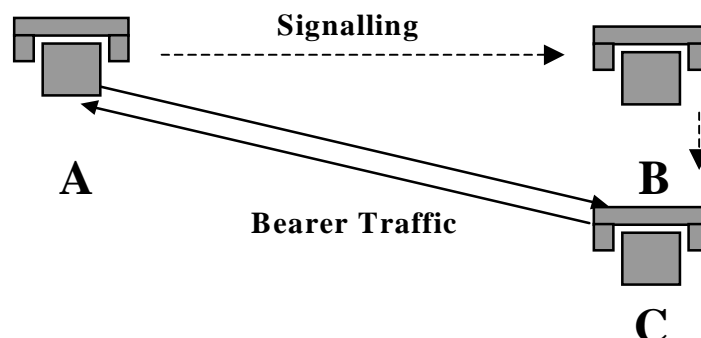

Figure 17: Interception for Call Forwarding / Deflection / ECT

The interception of party B once the supplementary service is invoked is a national option.

For Intercept Related Information it depends who is monitored:

- If subscriber A is monitored the number of A and B are mandatory in the event information and the number of C if available.
- If subscriber B is monitored the number of B and C are mandatory in the event information and the number of A if available.
- If subscriber C is monitored the number of C is mandatory in the event information and the number of A and B if available.

7 Invocation of Lawful Interception for Packet Data services

Figure shows the extract from the reference configuration which is relevant for the invocation of the Lawful Interception.

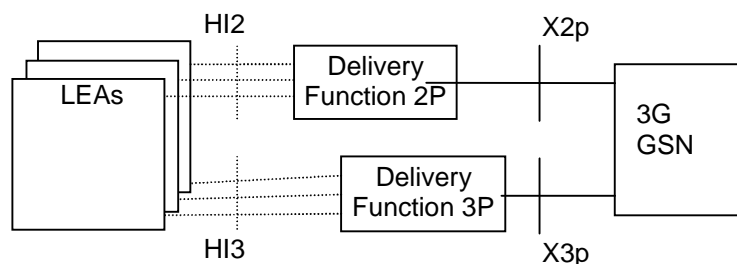

Figure 18: Functional model for Packet Data Lawful Interception invocation

The HI2 and HI3 interfaces represent the interfaces between the LEA and two delivery functions. Both interfaces are subject to national requirements. They are included for completeness, but are beyond the scope of this specification. The delivery functions are used:

- to convert the information on the X2p-interface to the corresponding information on the HI2 interface;
- to distribute the intercept related information to the relevant LEA(s);
- to distribute the intercept product to the relevant LEA(s).

In case a Packet Data communication is selected based on several identities (MSISDN, IMSI, IMEI,) of the same target, the 3G SGSN and/or, per national option 3G GGSN will deliver CC and IRI only once to the DF2P and DF3P. DF2P and DF3P will then distribute the information to the relevant LEAs.

For the delivery of the CC and IRI the 3G SGSN and/or, per national option 3G GGSN provides correlation number and target identity to the DF2P and DF3P which is used there in order to select the different LEAs where the product shall be delivered.

The correlation number is unique in the whole PLMN and is used to correlate CC with IRI and the different IRI's of one PDP context.

The correlation number shall be generated by using existing parameters related to the PDP context.

NOTE: If interception has been activated for both parties of the Packet Data communication both CC and IRI will be delivered for each party as separate intercept activity.

In case of location dependent interception :

- for each target, the location dependency check occurs at each Packet Data session establishment or release and at each cell and/or Routing Area (RA) update to determine permanently the relevant IAs (and deduce, the possible LEAs within these IAs),
- concerning the IRI:

3G Security Lawful Interception Requirements

27

- when an IA is left, a Mobile Station Detach event is sent when changing servicing 3 G G SNs or a cell and/or RA update event is sent when changing IAs inside the same servicing 3G SGSN to DF2P.
- when a new IA is entered a cell and/or RA update event is sent to DF2P and, optionally, a Start of Interception with Active PDP Context event for each PDP context
- concerning the CC, when crossing IAs, the CC is not sent anymore to the DF3P of the old IA but sent to the DF3P of the new IA.

7.1 Provision of Intercept Product - Short Message Service

Figure 19 shows an SMS transfer from the 3G SGSN node to the LEA. Quasi-parallel to the delivery from / to the mobile subscriber a message, which contains the content and header of the SMS, is generated and sent via the Delivery Function 2P to the LEA in the same way as the Intercept Related Information.

The IRI will be delivered to the LEA:

- for a SMS-MO, when the SMS-Centre receives the SMS;
- for a SMS-MT, when the MS receives the SMS.

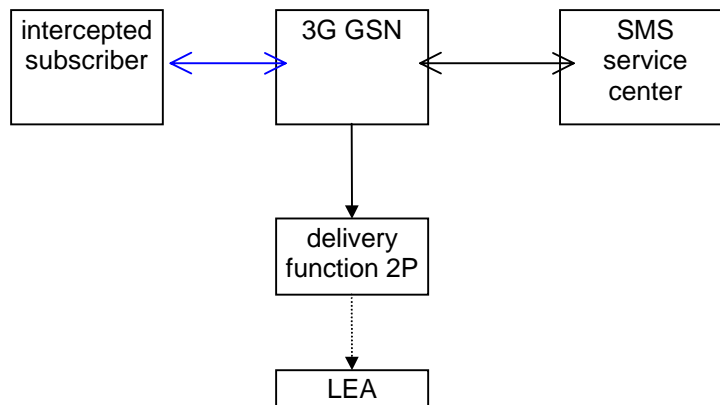

Figure 19: Provision of Intercept Product - Short Message Service

7.2 Provision of Intercepted Content of Communications – Packet data services

The access method for the delivering of Packet Data Intercept Product is based on duplication of packets without modification at 3G GSN. The duplicated packets with additional information in the header, as described in the following sections, are sent to DF3P for further delivery via a tunnel.

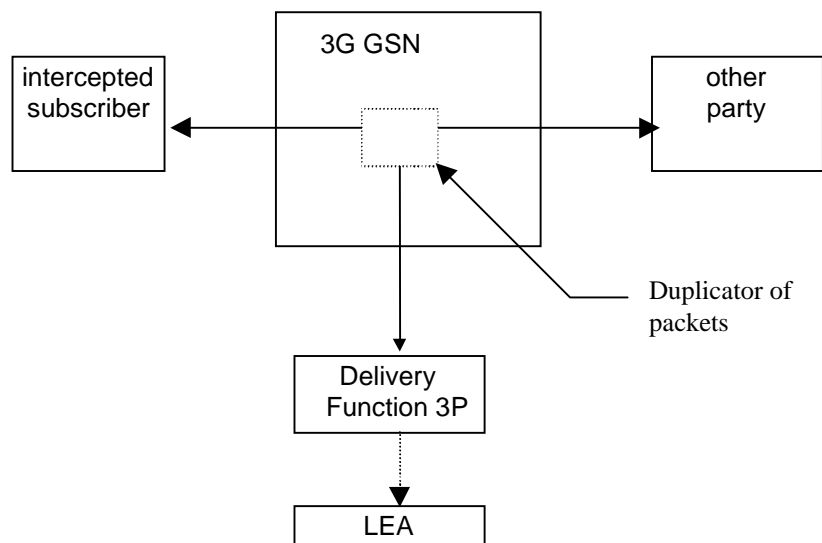

Figure 20: Configuration for interception of Packet Data product data

7.2.1 X3p-interface

In addition to the intercepted call content, the following information needs to be transferred from the 3G GSN to the DF3P in order to allow the DF3P to perform its functionality:

- target identity;
- correlation number;
- the target location (if available) or the IAs in case of location dependent interception.

Additional information may be provided as a national option.

7.3 Provision of Intercept Related Information

Intercept Related Information (Events) are necessary at the Mobile Station Attach, Mobile Station Detach, PDP Context Activation, Start of intercept with PDP context active, PDP Context Deactivation, Cell and/or RA update, and SMS events.

Figure 21 shows the transfer of intercept related information to the DF2P. If an event for / from a mobile subscriber occurs, the 3G GSN sends the relevant data to the DF2P.

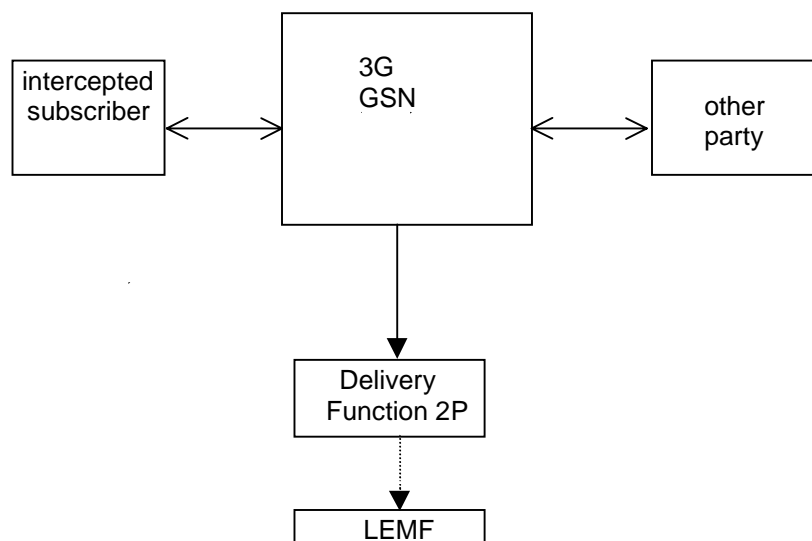

Figure 21: Provision of Intercept Related Information

7.3.1 X2p-interface

The following information needs to be transferred from the 3G GSN to the DF2P in order to allow a DF2P to perform its functionality:

- target identity (MSISDN, IMSI, IMEI);
- events and associated parameters as defined in section 7.3.2 and 7.4 may be provided;
- the target location (if available) or the IAs in case of location dependent interception.
- Correlation number

7.3.2 Structure of the events

There are seven different events in which the information is sent to the DF2P if this is required. Details are described in the following section. The events for interception are configurable (if they are sent to DF2P) in the 3G GSN and can be suppressed in the DF2P.

The following events are applicable to 3G SGSN:

- Mobile Station Attach;
- Mobile Station Detach;
- PDP context activation;
- Start of intercept with PDP context active;
- PDP context deactivation;
- Cell and /or RA update;
- SMS.

NOTE: 3G GGSN interception is a national option. Location information may not be available in this case.

The following events are applicable to the 3G GGSN:

- PDP context activation ;
- PDP context deactivation ;
- Start of interception with PDP context active.

3G Security Lawful Interception Requirements

30

A set of fields as shown below is used to generate the events. The events transmit the information from 3G GSN to DF2P. This set of fields as shown below can be extended in the 3G GSN, if this is necessary as a national option. DF2P can extend this information if this is necessary as a national option e.g. a unique number for each surveillance warrant.

Observed MSISDN MSISDN of the target subscriber (monitored subscriber)
Observed IMSI IMSI of the target subscriber (monitored subscriber)
Observed IMEI IMEI of the target subscriber (monitored subscriber), it shall be checked for each activation over the radio interface.
Event type Description which type of event is delivered: PDP attach, PDP detach, PDP context activation, Start of intercept with PDP context active, PDP context deactivation, SMS, Cell and/or RA update,
Event date Date of the event generation in the 3G GSN
Event time Time of the event generation in the 3G GSN
PDP address The PDP address of the target subscriber. Note that this address might be dynamic.
Access Point Name The APN of the access point. (Typically the GGSN of the other party)
Routing Area Code The routing area code of the target defines the RA in a PLMN.
PDP Type The used PDP type.
Correlation Number The correlation number is used to correlate CC and IRI.
SMS The SMS content with header which is sent with the SMS-service. The header also includes the SMS-Centre address.
CGI Cell Global Identity
Failed attach reason Reason for failed attach of the target subscriber.
Failed context activation reason Reason for failed context activation of the target subscriber.
IAs The observed Interception Areas

Table 2 Information Events for Packet Data Event Records

7.4 Packet Data related events

7.4.1 Mobile Station Attach

For attach an attach-event is generated. When an attach activation is generated from the mobile to servicing 3G GSN this event is generated. These fields will be delivered to the DF2P if available:

Observed MSISDN
Observed IMSI

3G Security Lawful Interception Requirements

31

Observed IMEI
Event Type
Event Time
Event Date
CGI
Routing area code
Failed attach reason
IAs (if applicable)

7.4.2 Mobile Station Detach

For detach a detach-event is generated, this is for the common (end) detach. These fields will be delivered to the DF2P if available:

Observed MSISDN
Observed IMSI
Observed IMEI
Event Type
Event Time
Event Date
CGI
Routing Area code
IAs (if applicable)

7.4.3 Packet Data PDP context activation

For PDP context activation a PDP context activation-event is generated. When a PDP context activation is generated from the mobile to 3G GSN this event is generated. These fields will be delivered to the DF2P if available:

Observed MSISDN
Observed IMSI
Observed IMEI
PDP address of observed party
Event Type
Event Time
Event Date
Correlation number
Access Point Name
PDP Type
CGI
Routing area code
Failed context activation reason
IAs (if applicable)

7.4.4 Start of interception with PDP context active

This event will be generated if interception for a target is started and if the target has at least one PDP context active. If more than one PDP context are open for each of them an event record is generated. These fields will be delivered to the DF2P if available:

3G Security Lawful Interception Requirements

32

Observed MSISDN
Observed IMSI
Observed IMEI
PDP address of observed party
Event Type
Event Time
Event Date
Correlation number
Access Point Name
PDP Type
CGI
Routing area code
IAs (if applicable)

7.4.5 Packet Data PDP context deactivation

At PDP context deactivation a PDP context deactivation-event is generated. These fields will be delivered to the DF2P if available:

Observed MSISDN
Observed IMSI
Observed IMEI
PDP address of observed party
Event Type
Event Time
Event Date
Correlation number
Access point name
CGI
Routing area code
IAs (if applicable)

7.4.6 Cell and/or RA update

For each cell and/or RA update an update-event with the fields about the new location is generated. These fields will be delivered to the DF2P if available:

Observed MSISDN
Observed IMSI
Observed IMEI
Event Type
Event Time
Event Date
CGI
Routing area code
IAs (if applicable)

7.4.7 SMS

For MO-SMS the event is generated in the 3G SGSN, when the SMS-Centre successfully receives the SMS; for MT-SMS the event is generated in the 3G SGSN when the target receives the message. This fields will be delivered to the DF2P if available:

Observed MSISDN
Observed IMSI
Observed IMEI
Event Type
Event Time
Event Date
CGI
Routing area code
SMS
IAs (if applicable)

7.5 Intercept cases for supplementary services

Supplementary services may be used with Packet Data. However they are not standardised and therefore Lawful Interception interwork cases can not be defined at the time of publication of this document.

8 Security

The security requirements are valid for the whole Lawful Interception system, i.e. rules and procedures shall be used for all involved entities, 3G GSN and the DF.

8.1 Administration security

The administration of the LI function, i.e. Activation, Deactivation and Interrogation of Lawful Interception, in the 3G GSN, 3G MSC and the DFs shall be done securely as described below:

- It shall be possible to configure the authorised user access within the serving network to Activate, Deactivate and Interrogate Lawful Interception separately for every physical or logical port at the 3G MSC and DF. It shall be possible to password protect user access.
- Only the ADMF is allowed to have access to the LI functionality in the 3G MSC, 3G GSN and DF.
- The communication links between ADMF, 3G GSN, 3G MSC, DF2, DF2P, and DF3, DF3P may be required by national option to support security mechanisms. Options for security mechanisms include:
 - CUG / VPN;
 - COLP;
 - authentication;
 - encryption.

Through the use of user access restrictions, no unauthorized network entities or remote equipment shall be able to view or manipulate LI data in the 3G GSN, 3G MSC or the DFs.

8.2 IRI security

8.2.1 Normal operation

The transmission of the IRI shall be done in a secure manner.

3G Security Lawful Interception Requirements

34

When DFs are physically separate from the 3G MSC and 3G GSN, the X2 and X2p-interfaces may be required by national option to support security mechanisms. Options for security mechanisms include:

- CUG/VPN;
- COLP;
- authentication;
- encryption.

8.2.2 Communication failure

Depending on the national law in case of communication failure IRI may be buffered in the 3G MSC and 3G GSN. After successful transmission of IRI the whole buffer shall be deleted. It shall be possible to delete the content buffer via command or a timer, in an unrestoreable fashion.

8.3 CC security

The transmission of the CC shall be done in a secure manner.

When DFs are physically separate from the 3G MSC and 3G GSN, the X3 and X3p-interfaces may be required by national option to support security mechanisms. Options for security mechanisms include:

- CUG/VPN;
- COLP;
- authentication;
- encryption.

In case of transmission failure no buffering is required within the intercepting network.

8.4 Security aspects of Lawful Interception billing

Billing information may be suppressed or made available at the DFs and the ADMF. Billing information for Lawful Interception shall be separated from "regular" billing data.

Billing data transmission to the Lawful Interception billing system may be done in a secure manner per national option.

In case of transmission failure billing-data shall be buffered/stored in a secure way. After successful transmission billing data shall be deleted in an unrestoreable fashion.

8.5 Other security issues**8.5.1 Log files**

Log files shall be generated by the ADMF, DF2, DF2P, DF3, DF3P, 3G MSC and the 3G GSN. All log files are retrievable by the ADMF, and are maintained by the ADMF in a secure manner.

8.5.2 Data consistency

The administration function in the PLMN shall be capable to perform a periodic consistency check to ensure that the target list of MSISDN, IMSI or IMEI is the same in all involved 3G MSCs and 3G GSNs in the PLMN and the DFs. The reference data base is the ADMF data base.

Annex A (informative):

Information flows for Lawful Interception invocation of circuit switched services

The following figures show the information flows for the invocation of Lawful Interception for various types of calls. The figures show some of the basic signalling messages of the target calls and the events on the X2 and X3-interfaces. The ISUP messages to and from the network are shown for informational purposes only; some of them may not be sent or may be combined in certain networks.

A.1 Mobile originated circuit switched calls

Figure A1 shows the interception of a basic mobile originated circuit switched speech or data call where the originating mobile (A) is the target for interception. B is not necessarily also a mobile subscriber and resides on a different exchange.

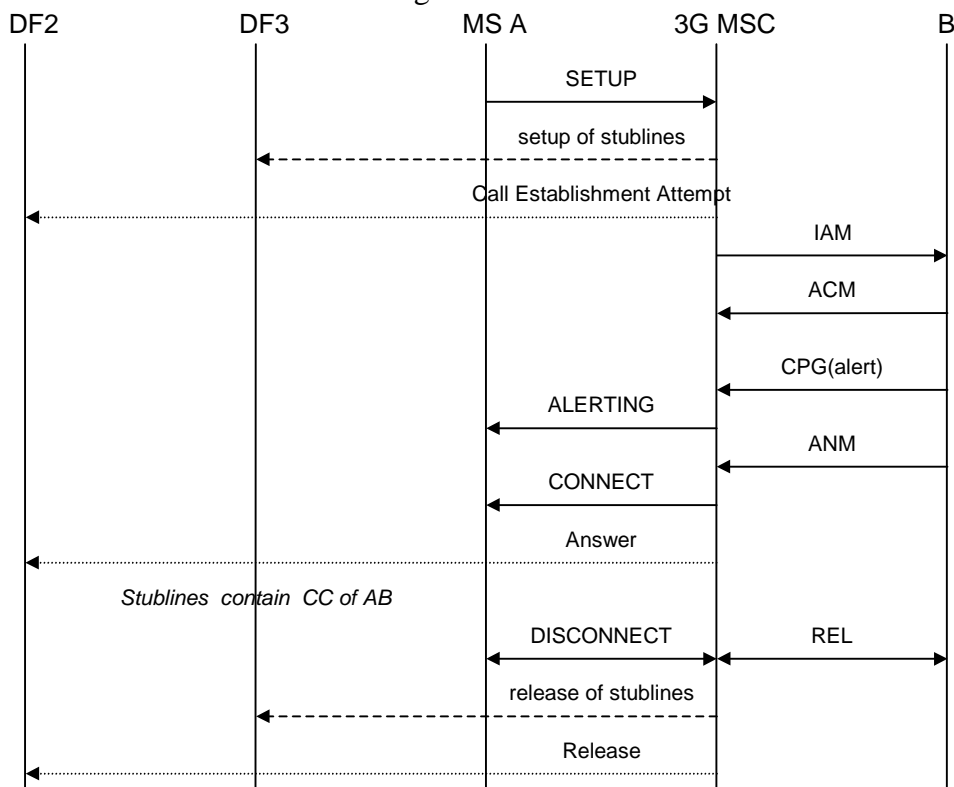

Figure A1: Interception of mobile originated circuit switched calls

In figure A1 the result (answer) of the set-up of the stublines is not shown. This assumes no special action is taken in case of failure.

A.2 Mobile terminated circuit switched calls

Figure A2 shows the interception of a basic mobile terminated circuit switched speech or data call where the terminating mobile (B) is the target for interception. A is not necessarily also a mobile subscriber and resides on a different exchange.

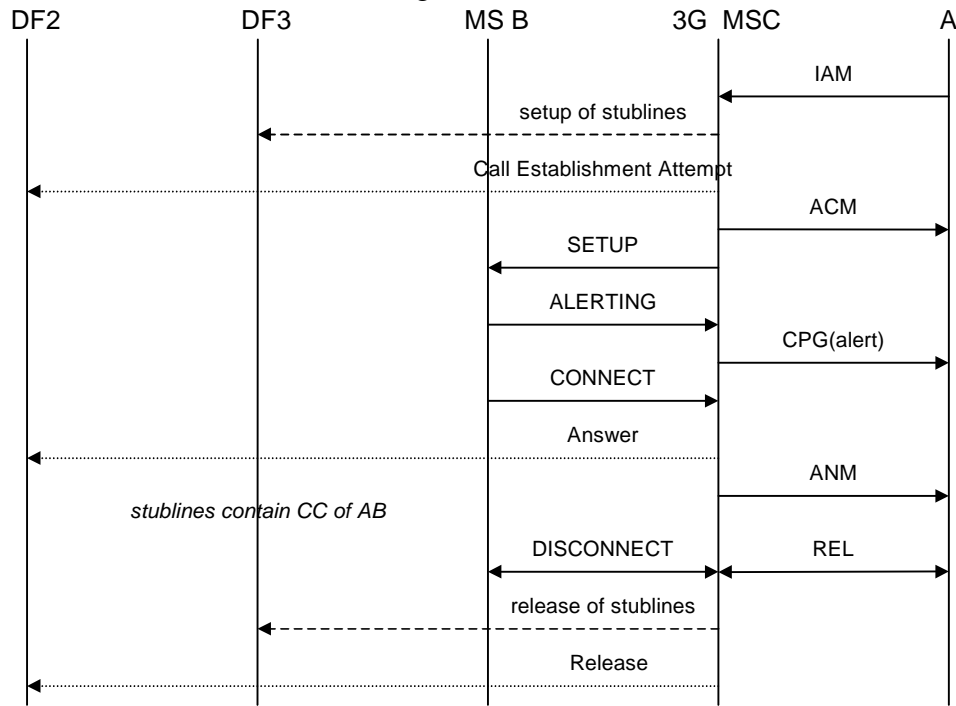

Figure A2: Interception of mobile terminated circuit switched calls

A.3 Call hold / call waiting

Figures A3 and A4 show the interception of calls involving call hold / call waiting. Figure A3 covers the case where one stubline or one pair of stublines is used per target, figure A4 covers the case where a separate stubline or pair of stublines is used for each target call. The mobile that receives the waiting call (A) is the target for interception.

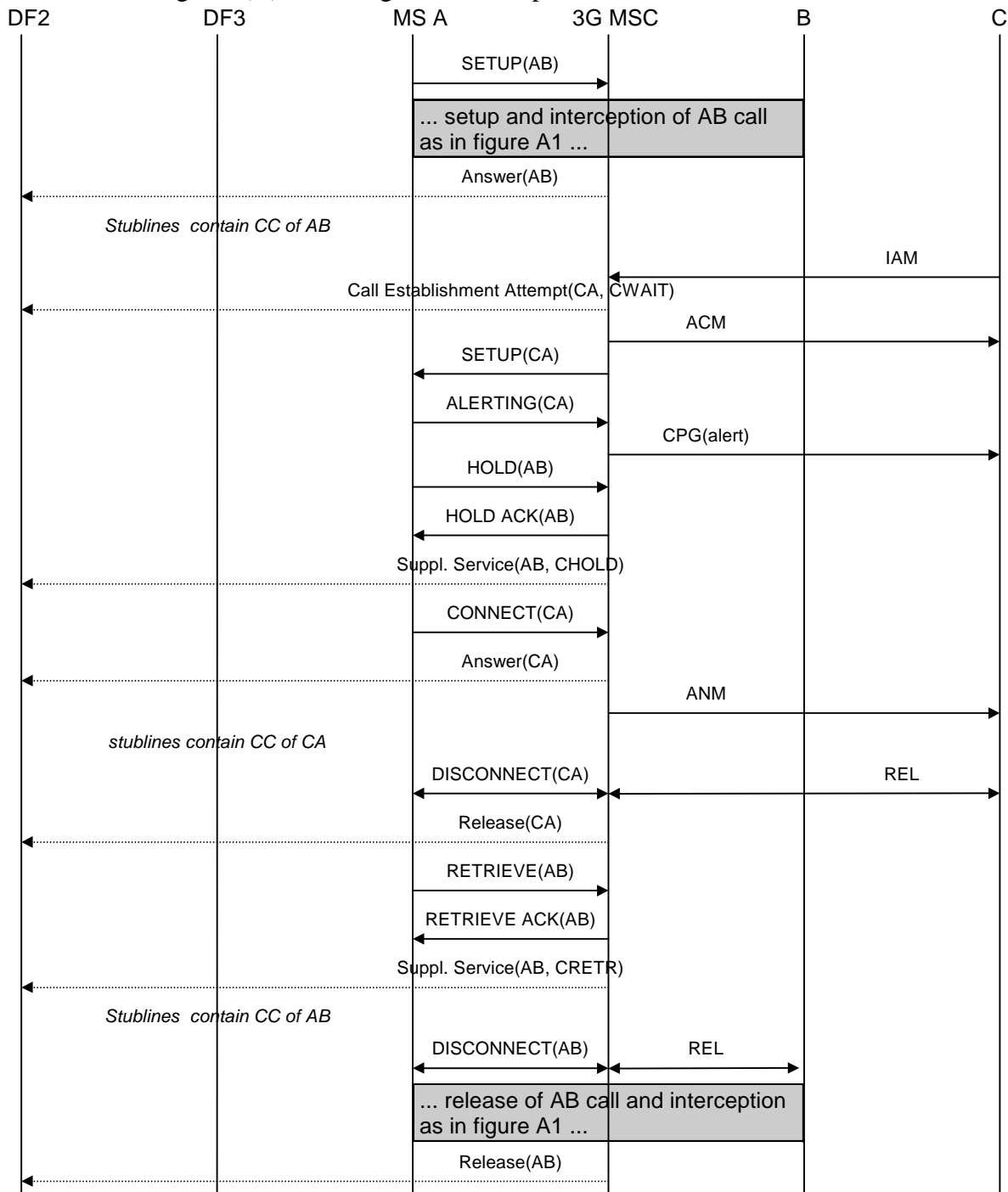

Figure A3: Interception of call hold / call waiting - stublines per target

3G Security Lawful Interception Requirements

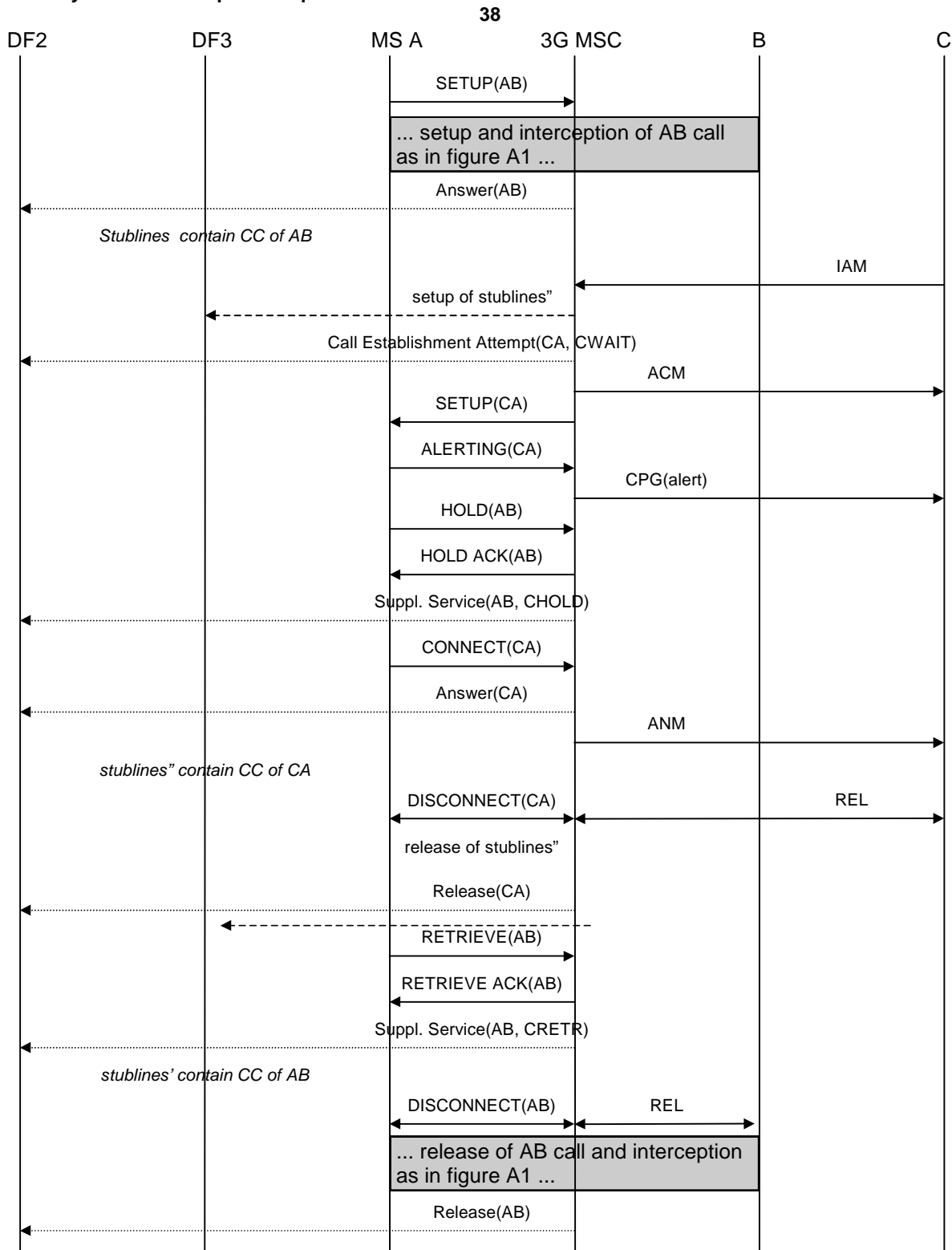

Figure A4: Interception of call hold / call waiting - stublines per target call

A.4 Multiparty calls

Figures A5 and A6 show the interception of multiparty calls. Figure A5 covers the case where one stubline or one pair of stublines is used per target, figure A6 covers the case where a separate stubline or pair of stublines is used for each target call. The mobile setting up the multiparty call (A) is the target for interception.

3G Security Lawful Interception Requirements

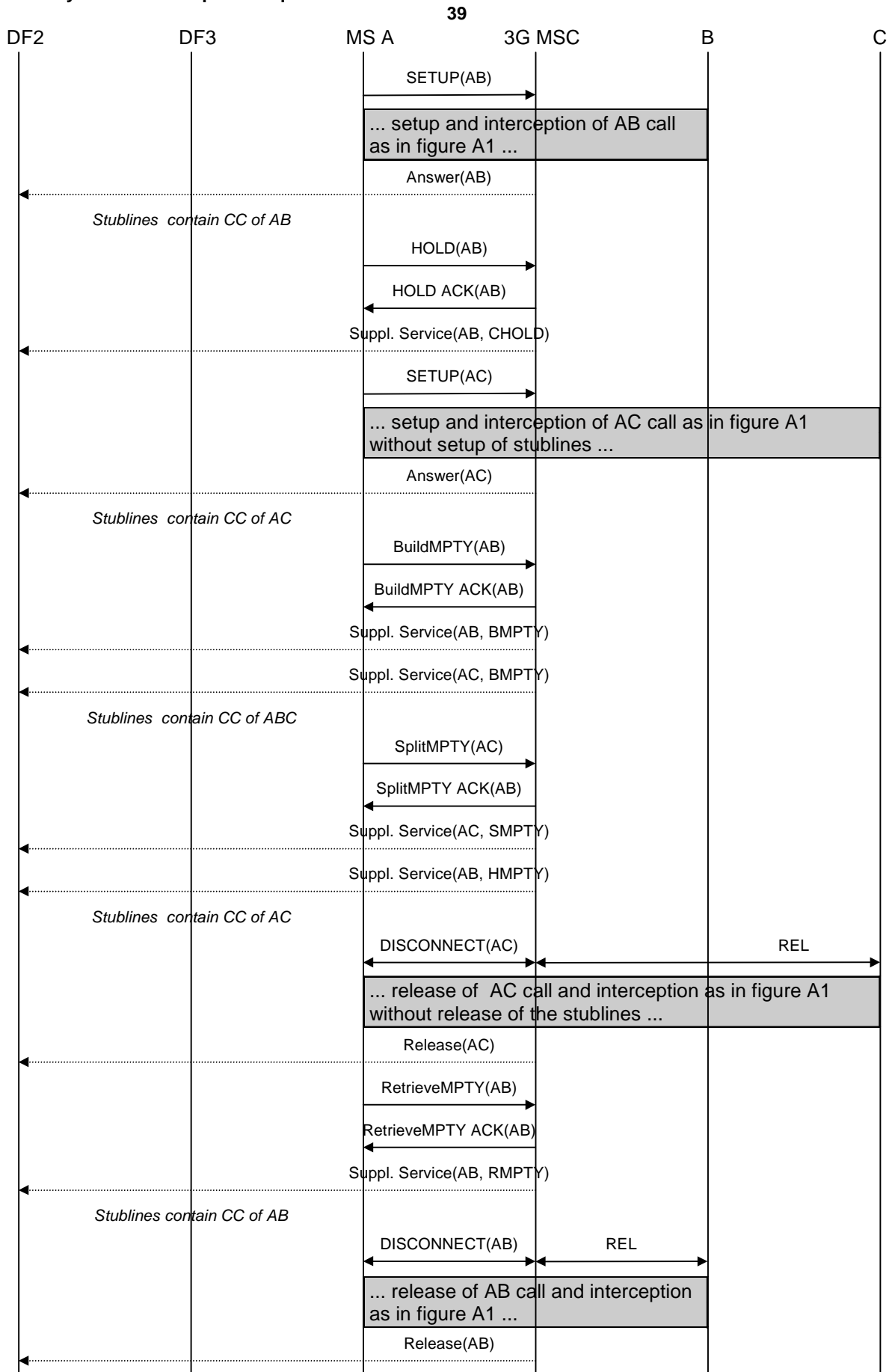

Figure A5: Interception of multiparty calls - stublines per target

3G Security Lawful Interception Requirements

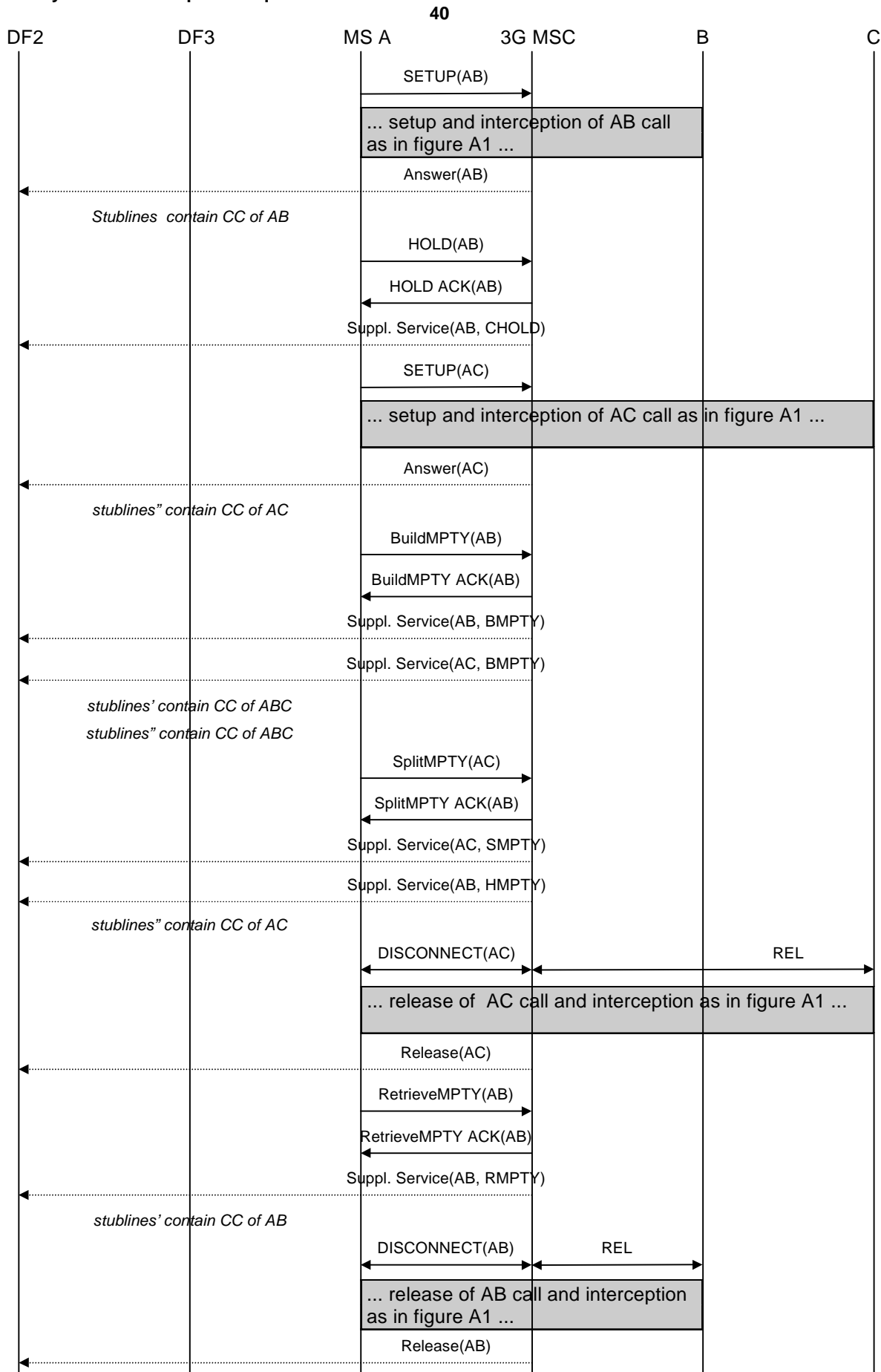

Figure A6: Interception of multiparty calls - stublines per target call

A.5 Call forwarding / call deflection

The following pictures show the information flows for the interception of forwarded calls. Information flows will be given for three typical cases of call forwarding. All other types of call forwarding / call deflection are intercepted similar to one of these.

A.5.1 Unconditional call forwarding

Figure A7 shows the interception of unconditionally forwarded calls. The mobile that activated unconditional call forwarding (B) is the target for interception. In this case interception will be performed at the 3G GMSC, where the Service Request Indicator (SRI) request for B is issued and subsequently the SRI response indicating that the call shall be forwarded is received.

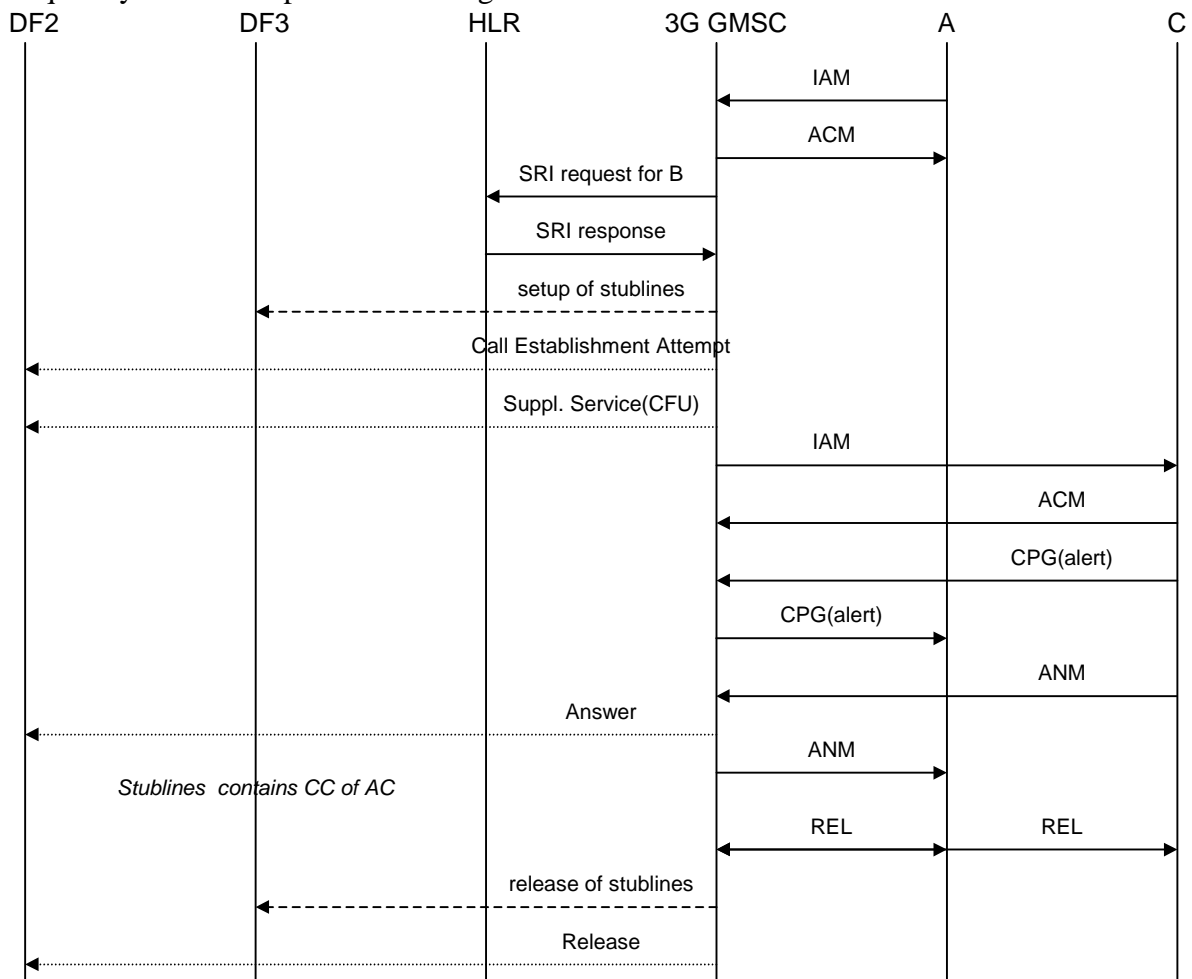

Figure A7: Interception of unconditional call forwarding

A.5.2 Call forwarding on not reachable (IMSI detached)

Call forwarding on not reachable because the IMSI is detached is also handled on the 3G GMSC. Interception of this type of call forwarding is similar to interception of unconditional call forwarding.

A.5.3 Call forwarding on busy (network determined)

Figure A8 shows the interception of call forwarding on busy (network determined). The mobile that activated call forwarding on busy (B) is the target for interception. In this case interception will be performed at the 3G MSC where B resides, where the busy condition is detected and the call is forwarded.

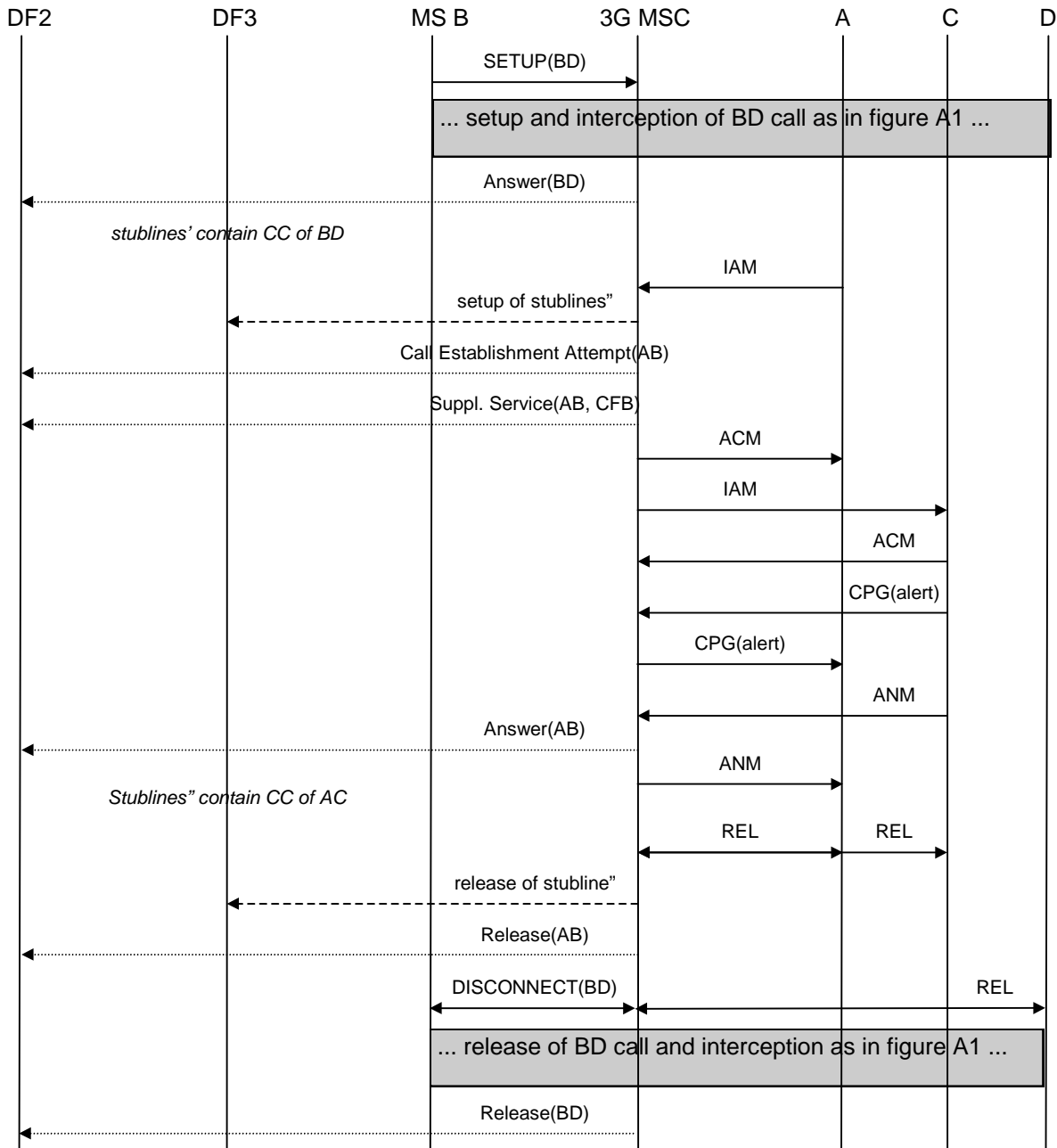

Figure A8: Interception of call forwarding on busy (network determined)

A.5.4 Call forwarding on not reachable (no response to paging/radio channel failure)

Call forwarding on not reachable because of no response to paging or radio channel failure is also handled on the 3G MSC similar to call forwarding on busy (network determined). Interception of this type of call forwarding is therefore done in the same way. (see section A.5.3)

A.5.5 Call forwarding on no reply

Figure A9 shows the interception of call forwarding on no reply. The mobile that activated call forwarding on no reply (B) is the target for interception. In this case interception will be performed at the 3G MSC where B resides, where the no reply condition is detected and the call is forwarded. Initially, the interception is similar to the interception of a basic mobile terminated circuit switched speech of data call. On no reply time-out, the interception will continue on the forwarded call to C.

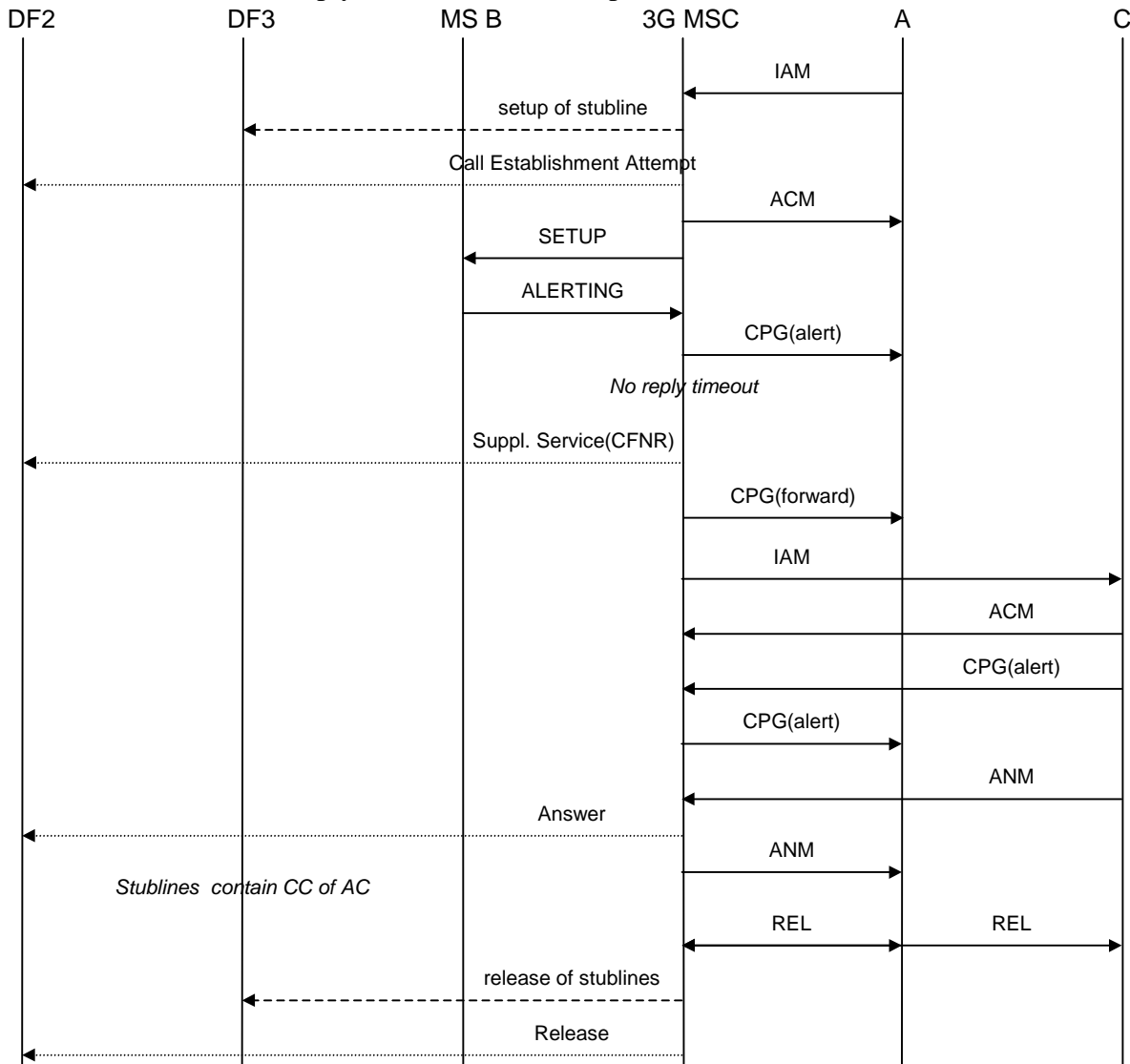

Figure A9: Interception of call forwarding on no reply

In figure A9 the release of the stublines is done after the forwarded call is released by A or C. It is a national option not to support interception of forwarded calls. In that case, the release of the stublines is done after the call is forwarded and B is no longer involved.

A.5.6 Call forwarding on busy (user determined)/call deflection

Call forwarding on busy (user determined) and call deflection are also handled on the 3G MSC similar to call forwarding on no reply. Interception of this type of call forwarding is therefore done in the same way. (see A5.5)

A.5.7 Call waiting / call forwarding on no reply

Figures A10 and A11 show the interception of a call involving both call waiting and call forwarding on no reply. Figure A10 covers the case where one stubline or one pair of stublines is used per target, figure A11 covers the case where a separate stubline or pair of stublines is used for each target call. The mobile that activated call forwarding on no reply and receives the waiting call (B) is the target for interception. In figure A10 a new (pair of) stublines needs to be set up when the call is forwarded since the first (pair of) stublines is still used for the initial call.

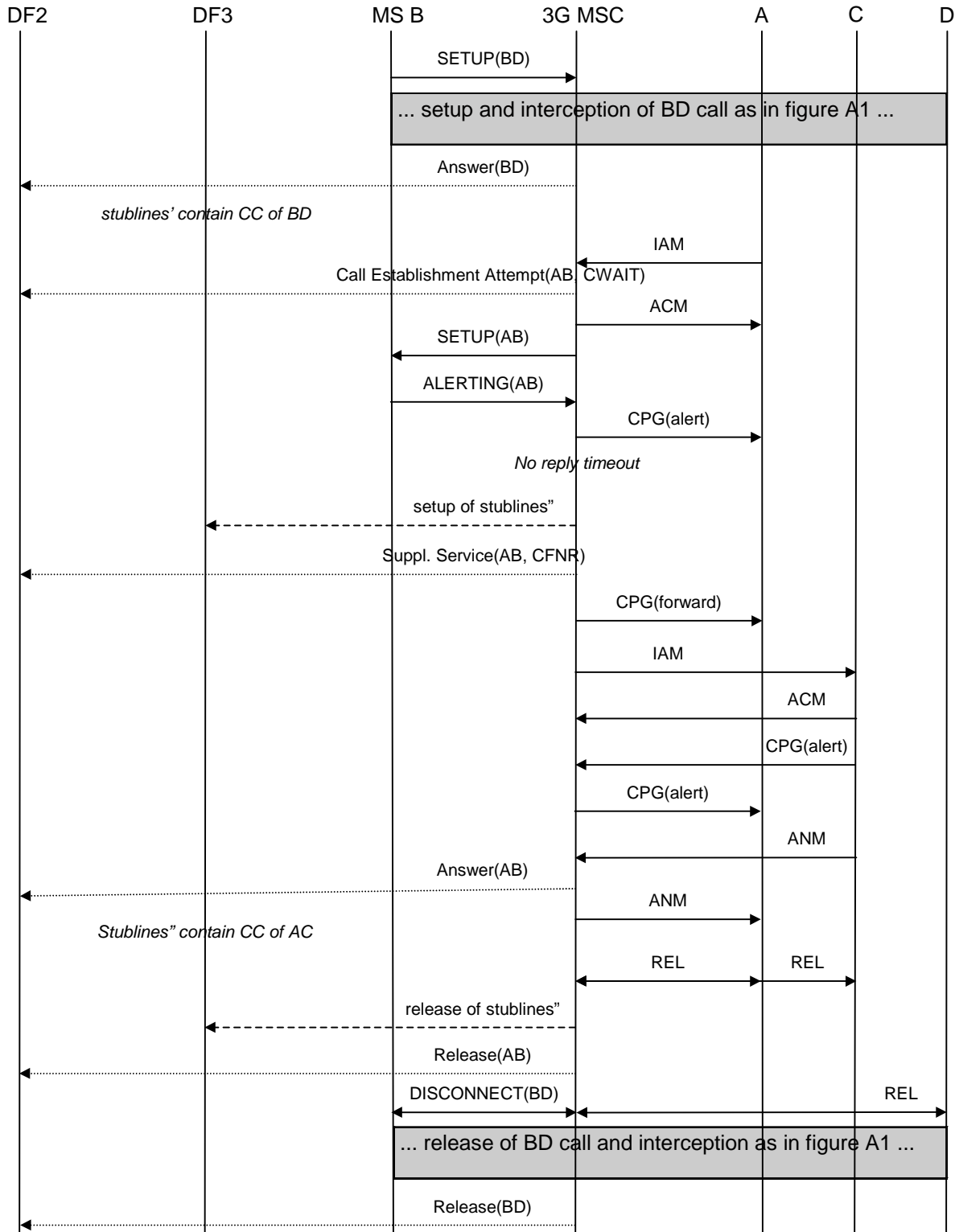

Figure A10: Interception of call waiting / call forwarding on no reply - stublines per target

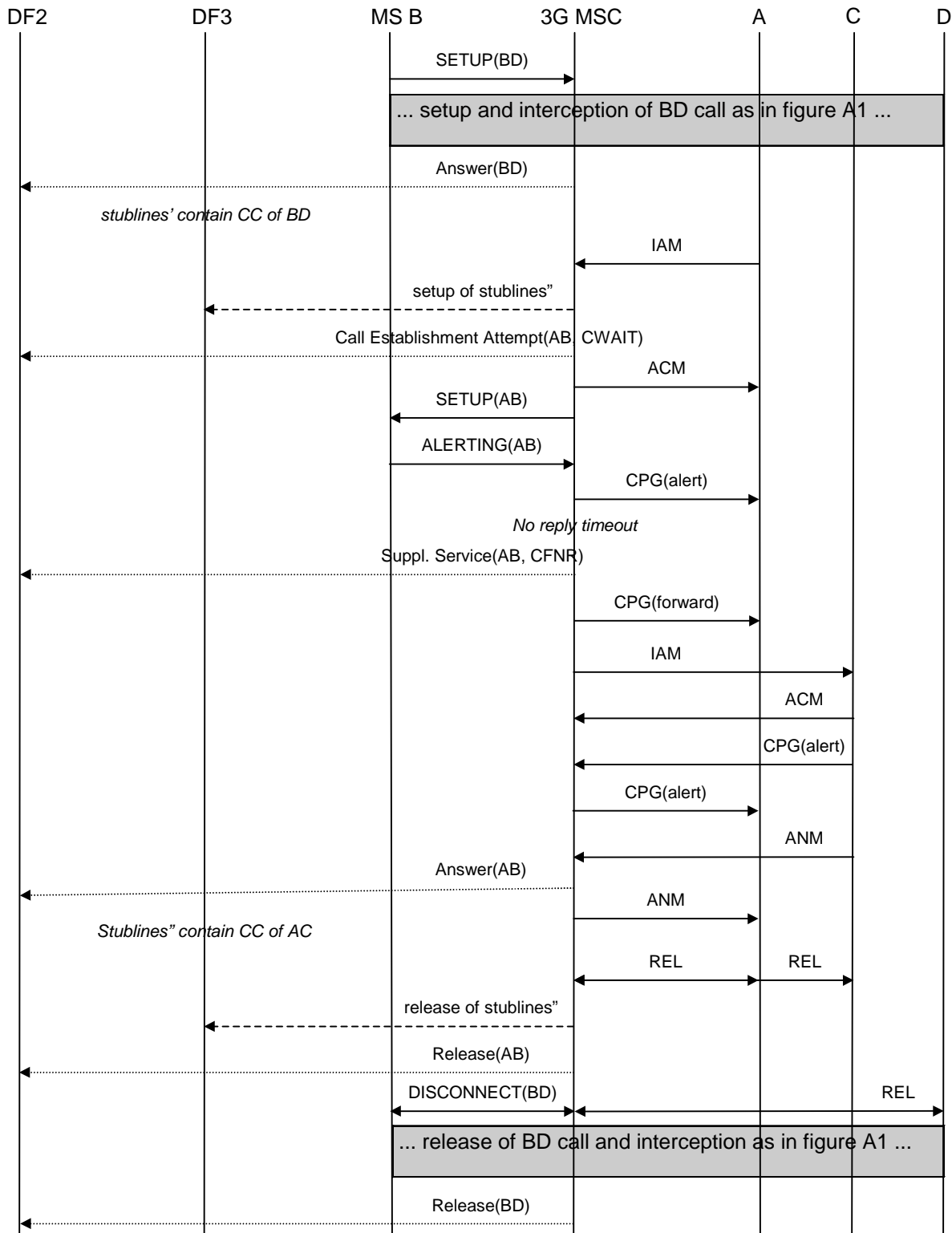

Figure A11: Interception of call waiting / call forwarding on no reply - stublines per target call

A.6 Explicit call transfer

Figures A12 and A13 show the interception of explicit call transfer. Figure A12 covers the case where one pair of stublines is used per target, figure A13 covers the case where a separate pair of stublines is used for each target call. The mobile transferring the call (B) is the target for interception.

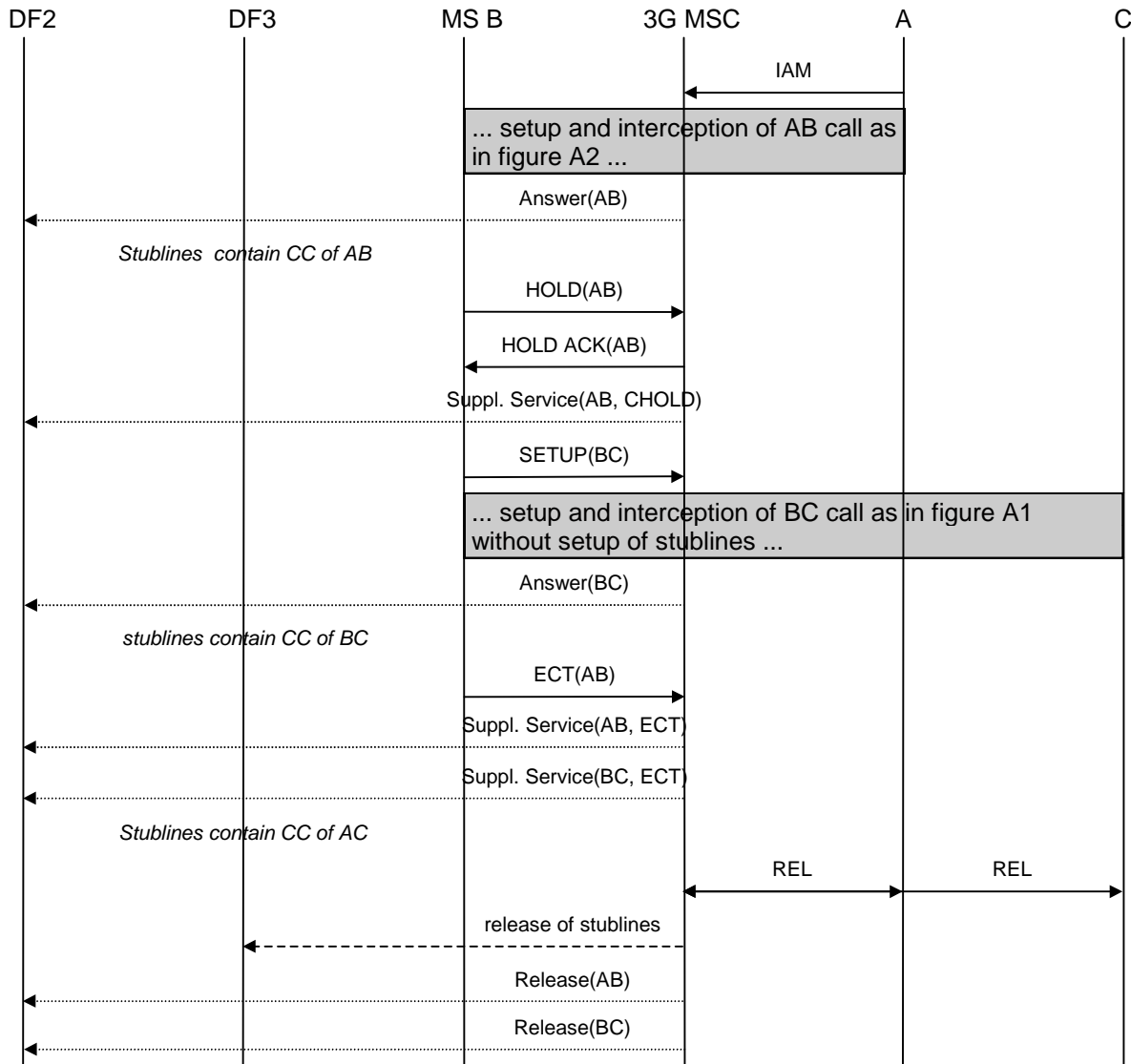

Figure A12: Interception of explicit call transfer - stublines per target

3G Security Lawful Interception Requirements

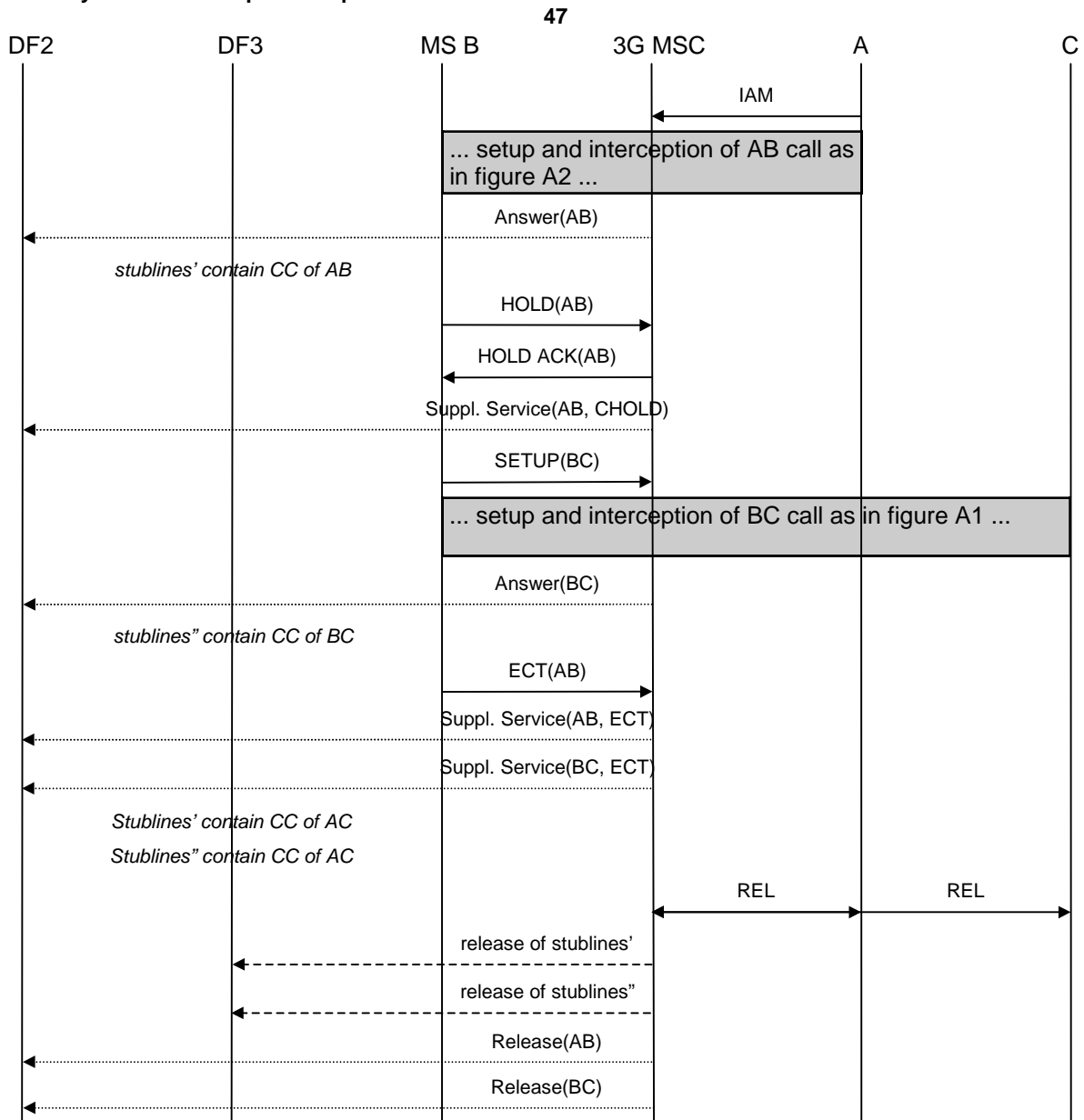

Figure A13: Interception of explicit call transfer - stublines per target call

In figures A12 and A13 the release of the stublines is done after the transferred call is released by A or C. It is a national option not to support interception of transferred calls. In that case, the release of the stublines is done after the call is transferred and B is no longer involved.

Annex B (informative): Information flows for Lawful Interception invocation of Packet Data services

The following figures show the information flows for the invocation of Lawful Interception for Packet Data and typical scenarios. The figures show some of the basic signalling messages of the target Packet Data communication and the events on the X2P and X3P interfaces. The dotted lines indicate signalling depending on whether CC and/or IRI information has been requested. The Gateway 3G GGSN may setup/release packet tunnels and send IRI information depending on national requirements.

The use of the Gateway 3G GGSN for interception is a national option.

B.1 Mobile Station Attach

Figure B1 shows the interception of a basic Mobile Station Attach where the mobile (A) is the target for interception.

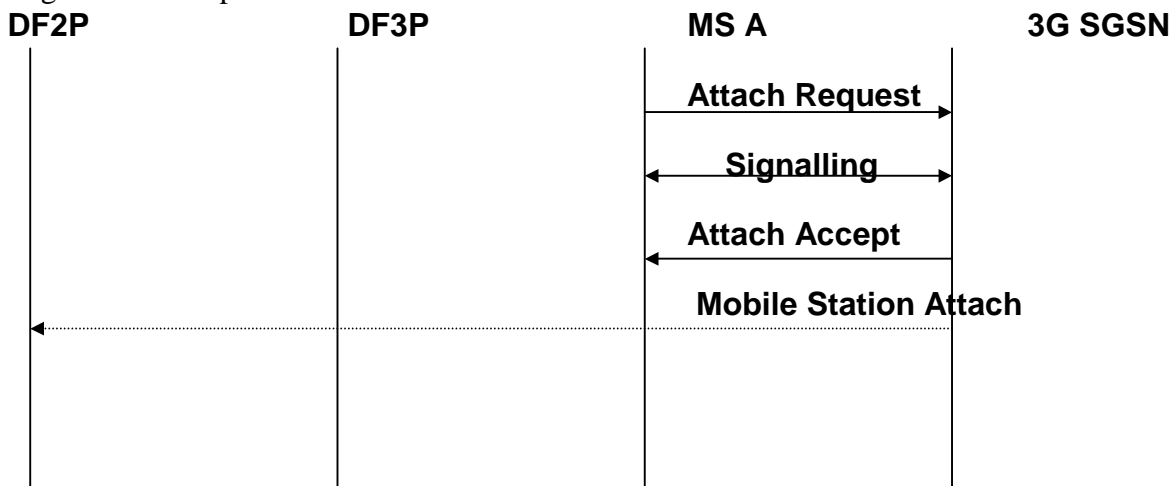

Figure B1: Interception of mobile originated Mobile Station Attachment

B.2 Mobile Initiated Mobile Station Detach

Figure B2 shows the interception of a Mobile Initiated Mobile Station Detach where the originating mobile (A) is the target for interception.

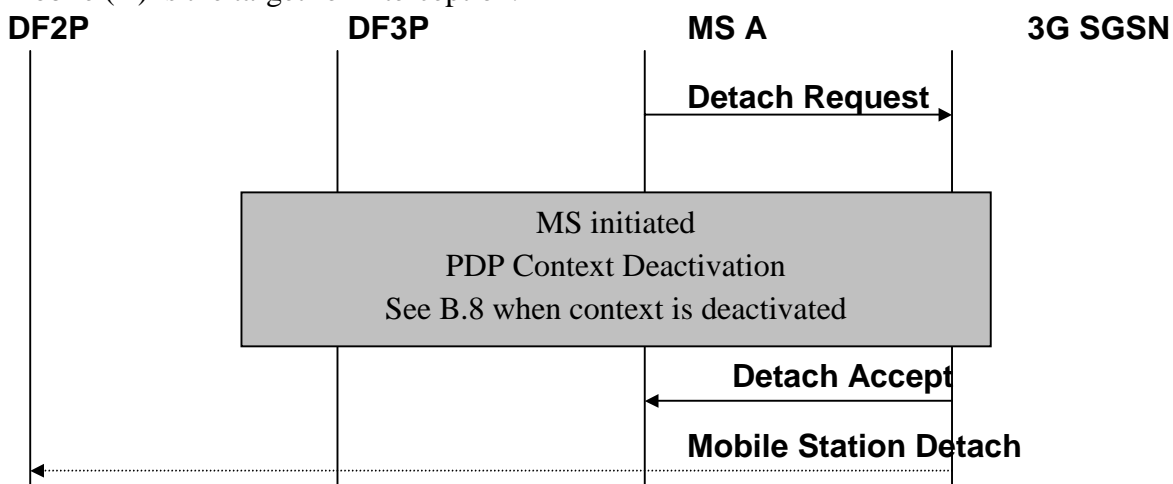
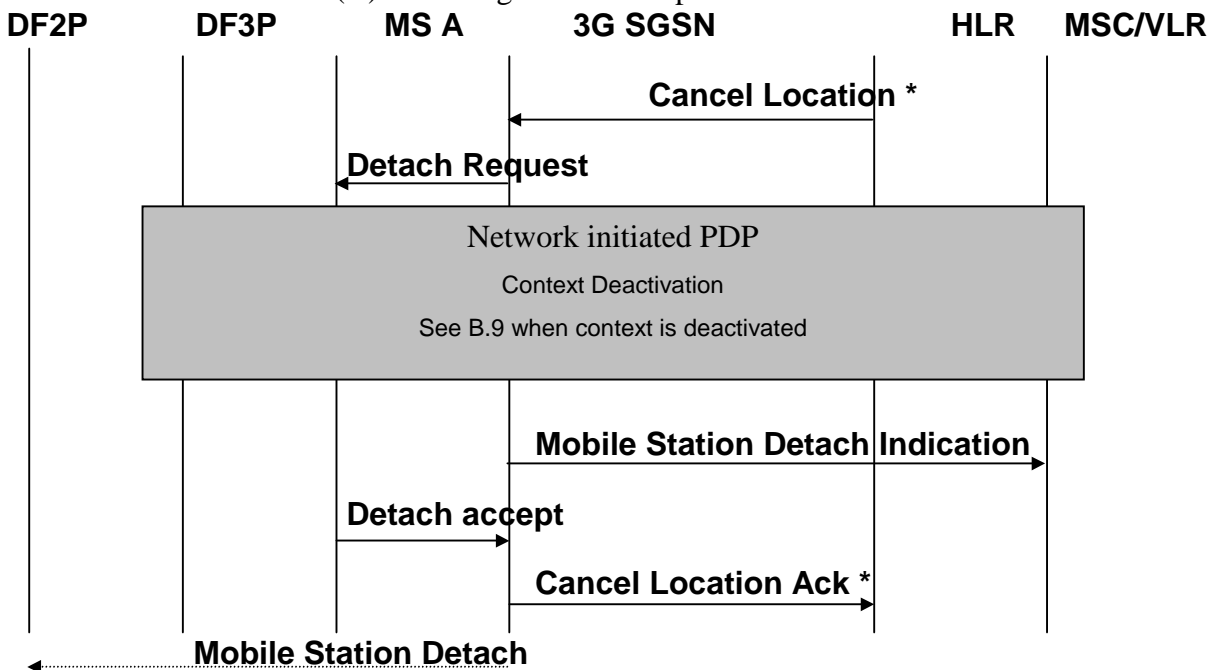

Figure B2: Interception of mobile originated Mobile Station Detachment

B.3 Network initiated Mobile Station Detach

Figure B3 shows the interception of a network initiated (by 3G SGSN or HLR) Mobile Station Detach where the mobile (A) is the target for interception.



NOTE: * Additional signals in case of HLR initiated

Figure B3: Interception of network initiated Mobile Station Detach.

B.4 Intra 3G GSN Routing Area Update

Figure B4 shows the interception of an Intra Routing Area Update where the mobile (A) is the target for interception. The sequence is the same for the combined RA / LA Update procedure but additional signalling is performed between the current 3G SGSN and the prior 3G SGSN before the Routing Area Update Accept message is sent to the MS.

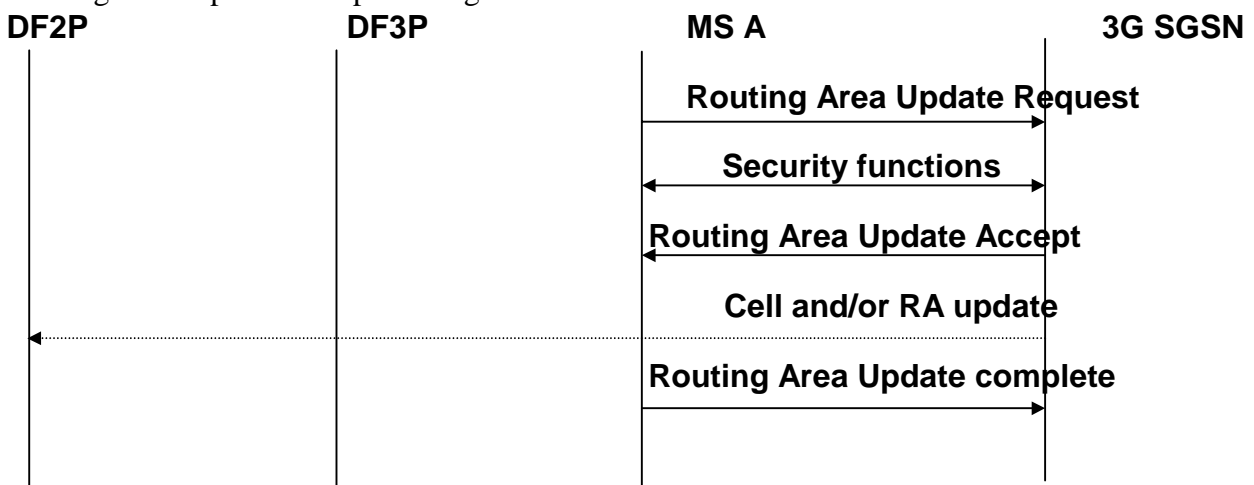

Figure B4: Interception of an Intra Routing Area Update

B.5 Inter 3G GSN Routing Area Update

Figure B5 shows the interception of an Inter Routing Area Update where the mobile (A) is the target for interception. The sequence is the same for the combined RA / LA Update procedure but additional signalling is performed between the 3G GSN, HLR and the old 3G GSN before the Routing Area Update Accept message is sent to the MS. In case of PDP context not being active less signalling is required.

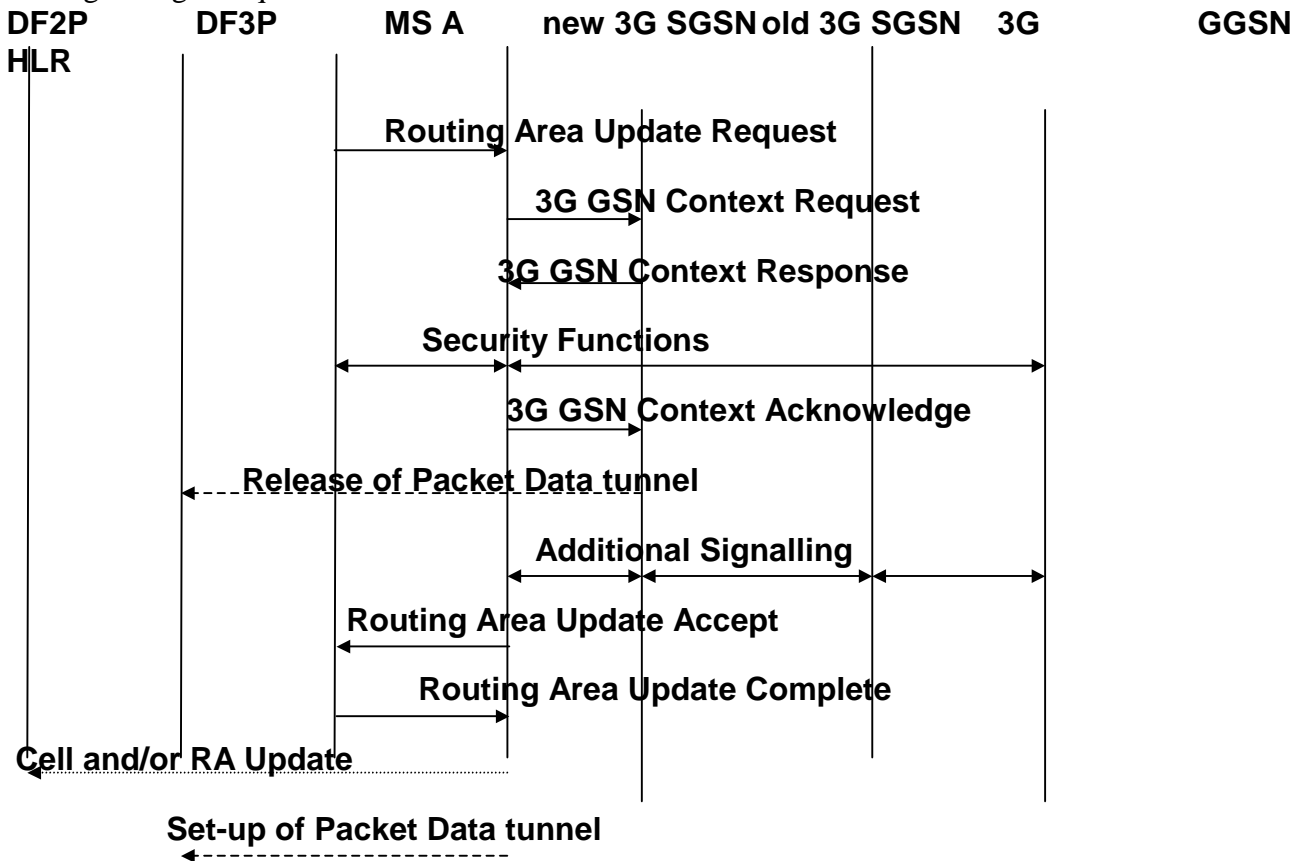

Figure B5: Interception of an Inter Routing Area Update

B.6 PDP Context Activation

Figure B6 shows the interception of a PDP Context activation where the mobile (A) is the target for interception. The sequence for a network initiated PDP Context activation is analogous but is preceded by the 3G GSN sending a Request PDP Context Activation to the MS.

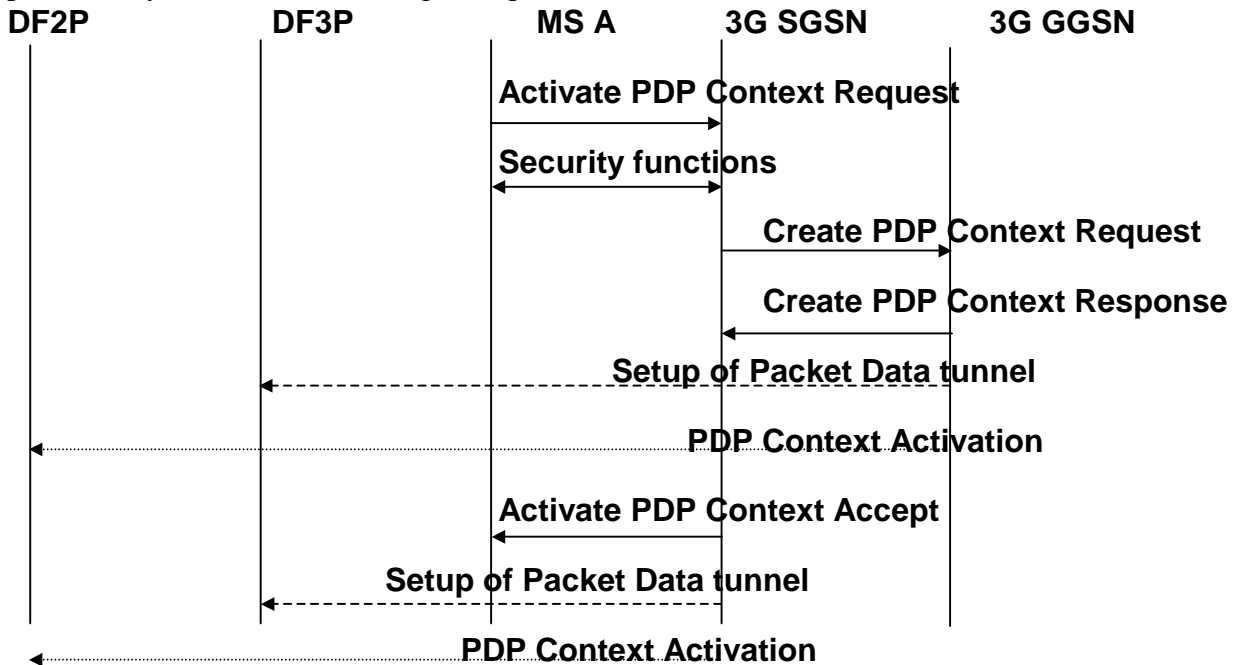

Figure B6: Interception of a PDP Context Activation

B.7 Start of interception with PDP context active

A tunnel is established to DF3P and an event is sent to DF2P.

B.8 MS initiated PDP Context Deactivation

Figure B7 shows the interception of a MS initiated PDP Context deactivation where the mobile (A) is the target for interception.

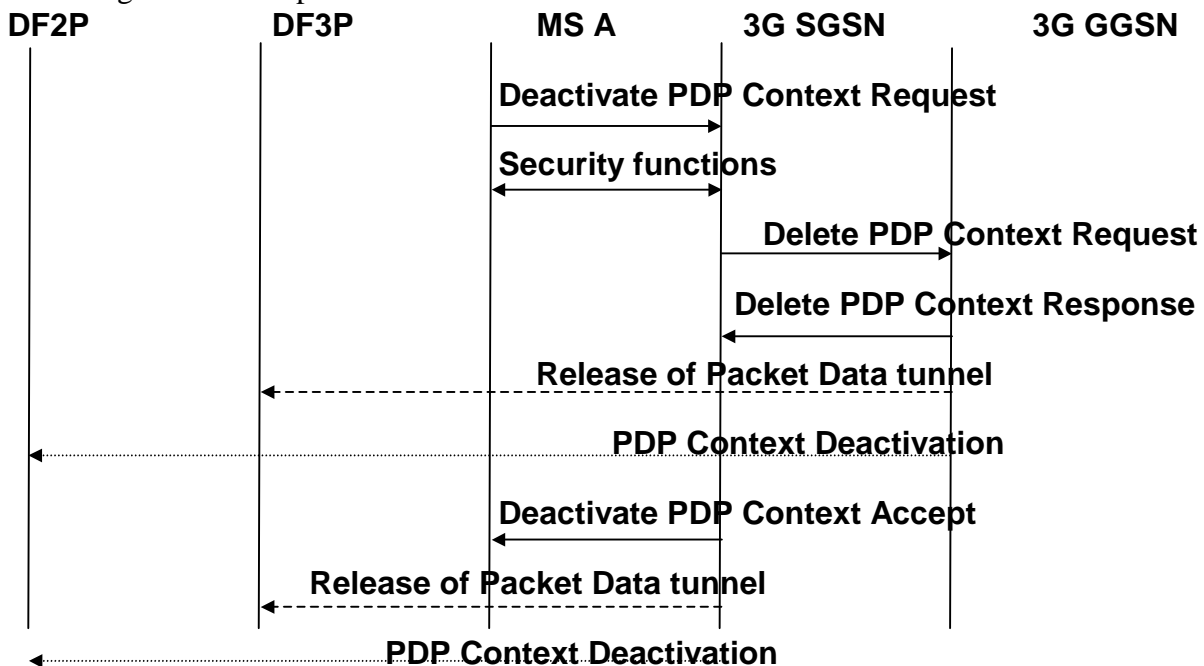

Figure B7: Interception of a PDP Context Deactivation

B.9 Network initiated PDP Context Deactivation

Figure B8 shows the interception of a Network initiated PDP Context deactivation where the mobile (A) is the target for interception. The 3G GGSN may send, (depending on national requirements) the PDP Context deactivation and release the Packet Data tunnel after the Delete PDP Context Response has been sent or received, (signalling between the 3G SGSN and the 3G GGSN is not shown here).

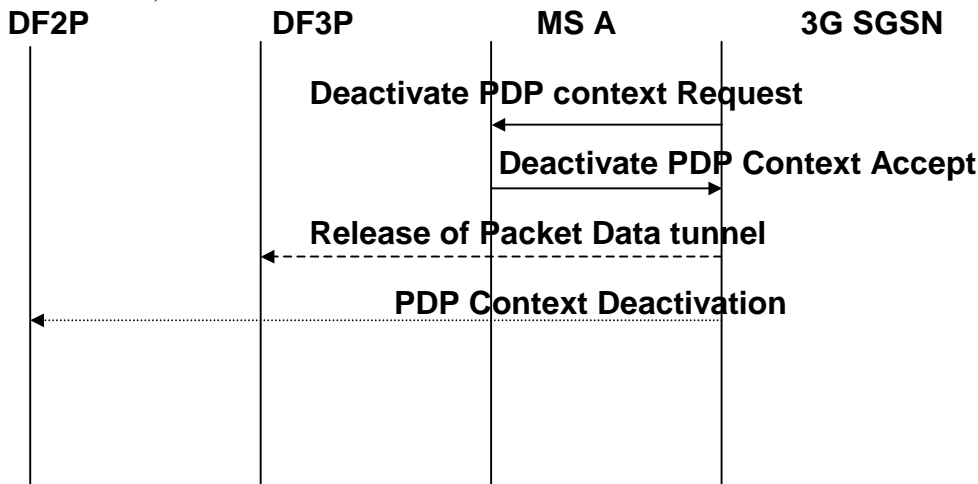

Figure B8: Interception of a Network initiated PDP Context Deactivation

B.10 SMS

Figure B9 and B10 show the interception of a Mobile-terminated SMS and a Mobile-originated SMS transfer where the mobile (A) is the target for interception.

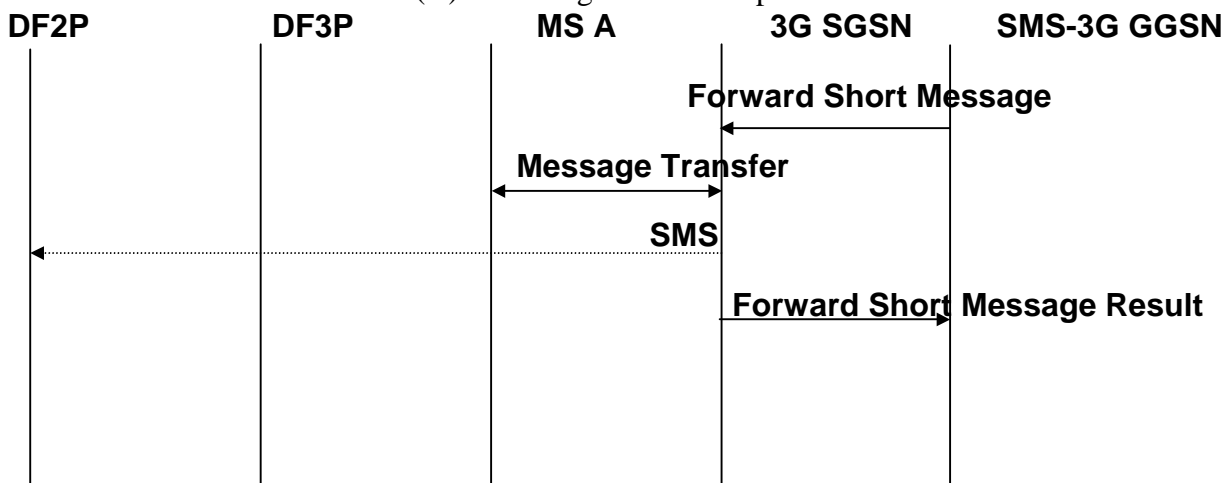

Figure B9: Interception of a Mobile-terminated SMS transfer

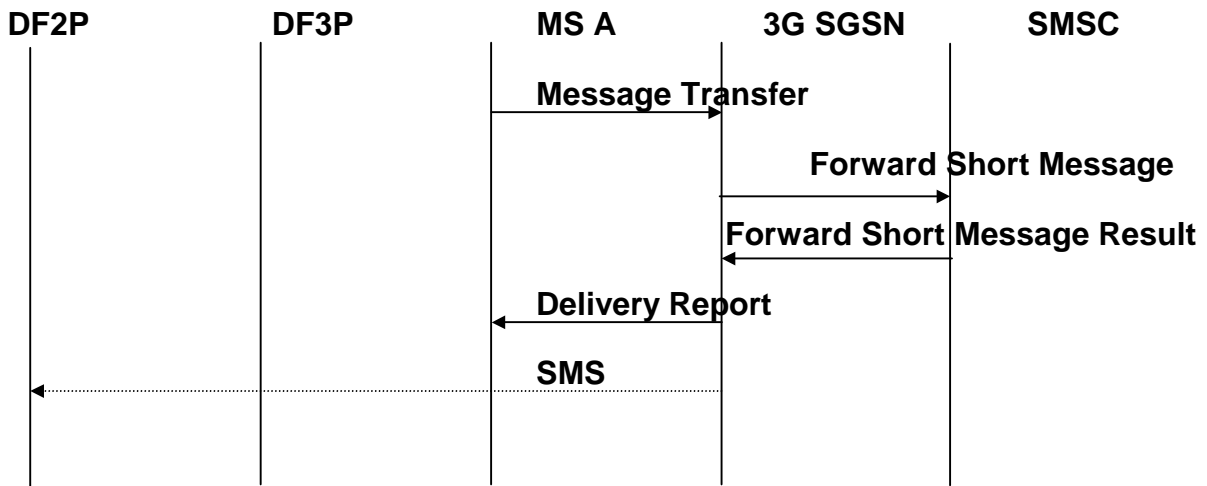

Figure B10: Interception of a Mobile-originated SMS transfer

History

Document history		
Edition x	<MMMM yyyy>	Publication as <old doctype> <old docnumber>
0.0.1	03 August 1999	draft
0.0.5	15 November 1999	Draft presented at SA3 #8 for information
1.0.0	03 December 1999	Initial Release, V1.0.0

Presentation of Specification to TSG or WG

Presentation to: TSG SA Meeting #6

Document for presentation: TS 33.107, Version 1.0.0

Presented for: Approval

Abstract of document:

This Technical Specification describes the Architecture and Functions for 3G lawful interception. Laws of individual nations and regional institutions (e.g. European Union), and sometimes licensing and operating conditions define a need to intercept telecommunications traffic and related information in modern telecommunications systems. It has to be noted that lawful interception shall always be done in accordance with the applicable national or regional laws and technical regulations.

This specification complements 33.106, Lawful interception requirements. There has not been raised any controversial issue during its genesis. The specification is presented for immediate approval, because lawful interception will be a mandatory regulatory requirement from the beginning.

There are no changes to other specifications resulting from the approval of 33.107.

Changes since last presentation to TSG SA WG3 Meeting #8:

Clarifications and Corrections of rather obvious nature.

Outstanding Issues:

None identified.

Contentious Issues:

None identified.