

**TSG-RAN WG3 meeting #6**  
**Sophia Antipolis, France, 24-27 August 1999**

*TSGR3#6(99)819*

**Agenda Item:**

**Source: Editor**

**Title: UMTS 25.832 Manifestations of Handover and SRNS Relocation v.2.2.0**

**Document for: Approval**

---

**Changes shown with revision marks are based on the decisions of the last RAN3 meeting. These changes have yet to be formally approved by the WG.**



**3<sup>rd</sup> Generation Partnership Project (3GPP);  
Technical Specification Group (TSG) RAN;**

**Manifestations of Handover and SRNS Relocation**

**3GPP**

---

Reference

<Workitem> (<Shortfilename>.PDF)

---

Keywords

<keyword[, keyword]>

**3GPP**

---

Postal address

---

Office address

---

Internet

secretariat@3gpp.org  
Individual copies of this deliverable  
can be downloaded from  
<http://www.3gpp.org>

---

**Copyright Notification**

No part may be reproduced except as authorized by written permission.  
The copyright and the foregoing restriction extend to reproduction in all media.

©  
All rights reserved.

# Contents

|   |      |
|---|------|
| Intellectual Property Rights .....                | 67   |
| Foreword .....                                    | 67   |
| Introduction.....                                 | 67   |
| 1 Scope .....                                     | 78   |
| 2 References .....                                | 78   |
| 3 Definitions, symbols and abbreviations .....    | 78   |
| 3.1 Definitions.....                              | 78   |
| 3.2 Symbols.....                                  | 78   |
| 3.3 Abbreviations.....                            | 78   |
| 4 General Aspects.....                            | 78   |
| 5 Manifestations of Handover .....                | 89   |
| 5.1 Intra Node B .....                            | 89   |
| 5.1.1 Intra Node B (intra Cell) .....             | 89   |
| 5.1.2 Intra Node B (inter Cell) .....             | 89   |
| 5.2 Inter Node B .....                            | 840  |
| 5.2.1 Inter Node B (Intra RNS) .....              | 840  |
| 5.2.2 Inter Node B (Inter RNS, with Iur).....     | 840  |
| 5.2.3 Inter Node B (Inter RNS, without Iur) ..... | 942  |
| 5.3 Inter URAN (different URAN types) .....       | 942  |
| 5.4 Inter CN (same URAN types) .....              | 943  |
| 5.5 Inter CN (different URAN types).....          | 943  |
| 5.6 Inter CN (different CN/URAN types) .....      | 944  |
| 5.7 Intra CN (UTRAN-GSM/GPRS) .....               | 944  |
| 6 Applicability of the Scenarios .....            | 1045 |
| History .....                                     | 1146 |

---

# Intellectual Property Rights

## Foreword

This Technical Report has been produced by the 3<sup>rd</sup> Generation Partnership Project, Technical Specification Group RAN.

The contents of this TR may be subject to continuing work within the 3GPP and may change following formal TSG approval. Should the TSG modify the contents of this TR, it will be re-released with an identifying change of release date and an increase in version number as follows:

Version m.t.e

where:

- m indicates [major version number]
- x the second digit is incremented for all changes of substance, i.e. technical enhancements, corrections, updates, etc.
- y the third digit is incremented when editorial only changes have been incorporated into the specification.

---

## Introduction

This paper describes the various manifestations of handover to be supported by the proposed UTRAN architecture. There are several reasons for doing this:

- to ensure that all scenarios have been captured and can be developed
- so that the requirements for the UTRAN/CN entities and interfaces can be defined
- to raise and discuss issues concerning the architecture

The mapping of the scenarios onto public/private domains is outside the scope of the document.

Unless otherwise stated, the scenarios are supported by Release '99 of the standard.

---

# 1 Scope

The present document identifies a number of handover and SRNS Relocation scenarios for UTRAN. It is intended to reflect and clarify the requirements on UTRAN, and to assist in the development of procedures and capabilities.

---

## 2 References

The following documents contain provisions which, through reference in this text, constitute provisions of the present document.

- References are either specific (identified by date of publication, edition number, version number, etc.) or non-specific.
  - For a specific reference, subsequent revisions do not apply.
  - For a non-specific reference, the latest version applies.
  - A non-specific reference to an ETS shall also be taken to refer to later versions published as an EN with the same number.
- 

## 3 Definitions, symbols and abbreviations

### 3.1 Definitions

For the purposes of the present document, the following terms and definitions apply.

Handover                the transfer of a user's connection from one radio channel to another (can be same or different cell).

SRNS Relocation      the change of Iu instance. It should be noted that SRNS Relocation was previously known as Streamlining.

*[editor's note: an improved definition of handover is for further study]*

### 3.2 Symbols

For the purposes of the present document, the following symbols apply:

### 3.3 Abbreviations

For the purposes of the present document, the following abbreviations apply:

---

## 4 General Aspects

The scenarios show the relationship between radio interface mobility with Iu interface mobility.

It should be noted that in all scenarios where the UE is connected to UTRAN, the connection can use Dedicated or Common channels, in either FDD or TDD mode. In Common Transport Channel state, only hard handover is possible, while in DCH state both hard and soft handover may be possible (depending on scenario).

For handover between FDD and TDD modes, only hard handover is possible.

Throughout the paper handovers are shown in both directions (i.e. the scenarios are symmetric).

It is assumed that support of inter-PLMN soft handover is not required.

All handover scenarios that are supported for Release '99 shall support simultaneous mode operation.

## 5 Manifestations of Handover

### 5.1 Intra Node B

#### 5.1.1 Intra Node B (intra Cell)

This scenario covers the case where the mobile does not change cell, but changes frequency/code. This scenario shall be supported by the UTRAN. Steps (i) & (ii) show the situation before and after.

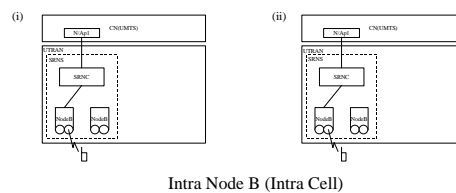

#### 5.1.2 ~~Scenario 1b:~~ Intra Node B (inter Cell)

This scenario is the other case of the intra Node B handover, where the radio session is handed from one cell to another, both within the same Node B. In the case of a dual mode Node B, intra Node B handover may include a change of mode (TDD $\leftrightarrow$ FDD). This scenario shall be supported by the UTRAN, for both hard and soft handover. For hard handover, step (ii) is omitted.

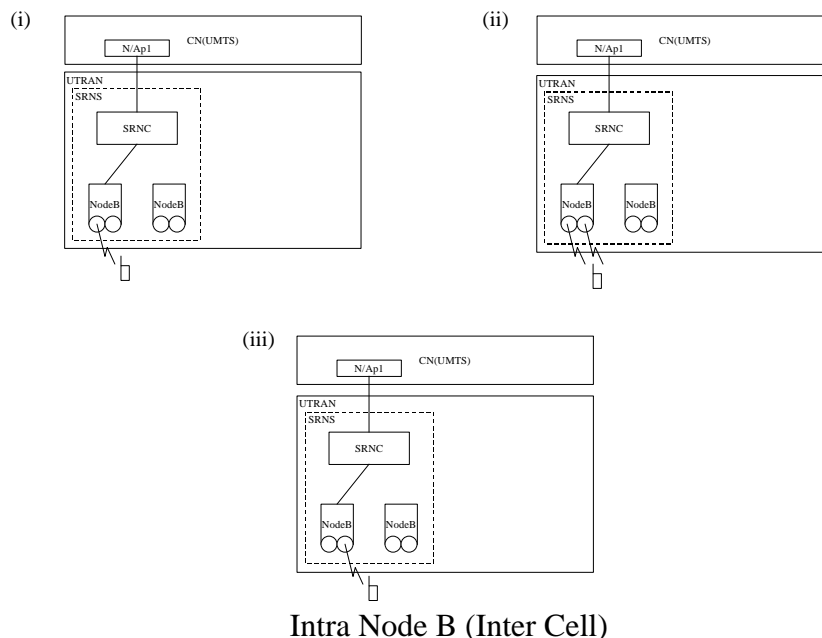



## 5.2 Inter Node B

### 5.2.1 Inter Node B (Intra RNS)

This scenario involves a change of Node B, so in a soft handover situation the uplink “combining” (or selection) occurs at the RNC. In the case of a dual mode RNC, intra RNS handover may include a change of mode (TDD $\leftrightarrow$ FDD). Again, this shall be supported by the UTRAN for both soft and hard handover cases. For hard handover, step (ii) is omitted.

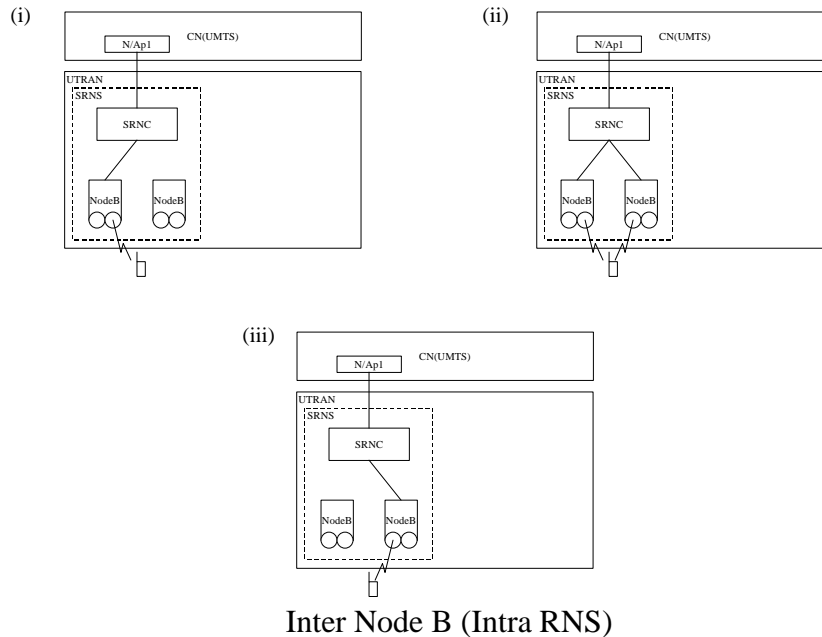

### 5.2.2 Inter Node B (Inter RNS, with Iur)

In this scenario, the handover still occurs within the UTRAN, but is now between cells under the control of different RNCs; it is outside the scope of this document what the implications of the access points (N/Ap) being in the same or different core network nodes are. The scenario can be split into two phases – handover and SRNS relocation. For a particular UE, the SRNS Relocation phase is optional. It may be executed at any time by UTRAN (SRNC) in the case of a UE moving to a cell which belongs to a different RNC from the current SRNC.

Inter RNS hard handover may include a change of mode (FDD $\leftrightarrow$ TDD).

This scenario will be supported by the UTRAN as both soft and hard handover.

In the first set of figures (soft handover), steps (i) & (ii) show the UE entering the macrodiversity state; step (iii) shows the UE connected to a DRNC only. Either step (ii) or step (iii) can be the starting point for SRNS relocation (see below). However, for Release '99, the starting points for SRNS relocation may be restricted – see below.

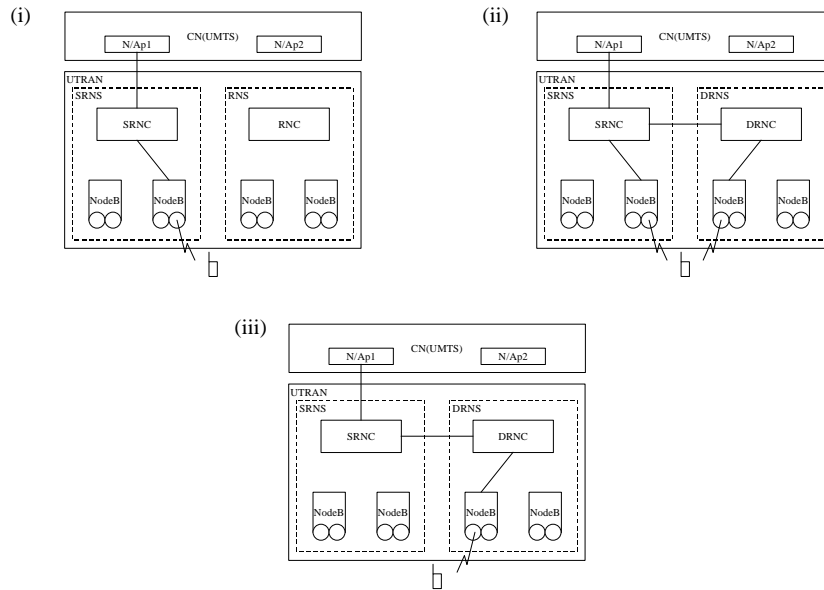

### Inter RNS Soft Handover

In the hard handover figures, steps (i) & (ii) show the handover. Step (ii) is the starting point for any subsequent SRNS relocation (see below).

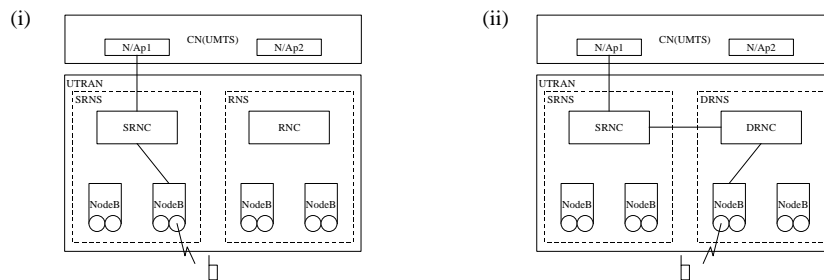

### Inter RNS Hard Handover

The SRNS relocation phase can either be initiated when the UE is only connected through one or more drift RNCs (iii), or when the connection is also using radio resources directly controlled by the Serving RNC (i). However, for Release 99, it may only be possible to support the case where all radio links are in a single DRNS and that DRNC is the target RNC (i.e. a special case of step (iii) where there is only one DRNC, as depicted). Steps (ii) and (iv) show the situation after the SRNS Relocation has occurred.

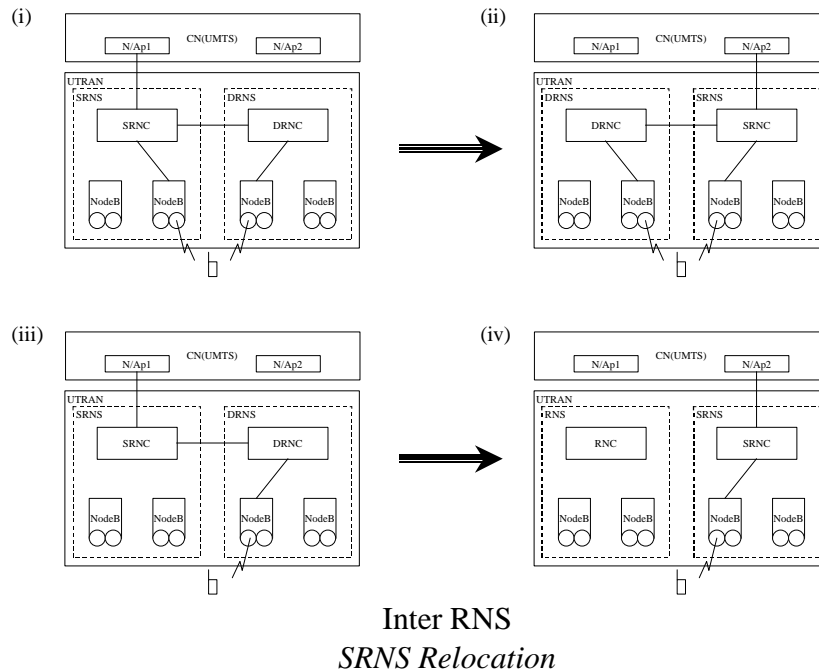

### 5.2.3 Inter Node B (Inter RNS, without Iur)

This scenario shows the case where there is no Iur interface between the RNSs. This scenario will be supported by UTRAN as hard handover only and may include a change of mode (TDD $\leftrightarrow$ FDD). Steps (i) & (ii) show the situation before and after.

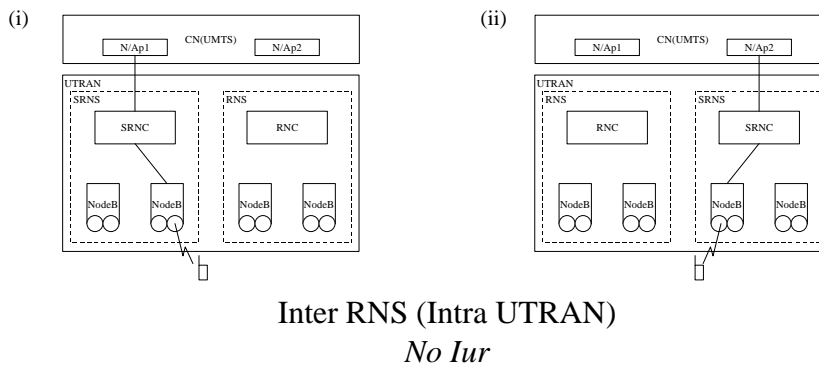

## 5.3 Inter UTRAN (different UTRAN types)

This scenario is for handover between a UTRAN and another type of radio access (e.g. BRAN) both connected to a UMTS core network. This scenario will not be supported by UTRAN in Release '99. This scenario does not include the case of handover to/from GSM, as this is considered as a separate scenario (see below). Steps (i) & (ii) show handover from UTRAN. Steps (iii) & (iv) show handover to UTRAN.

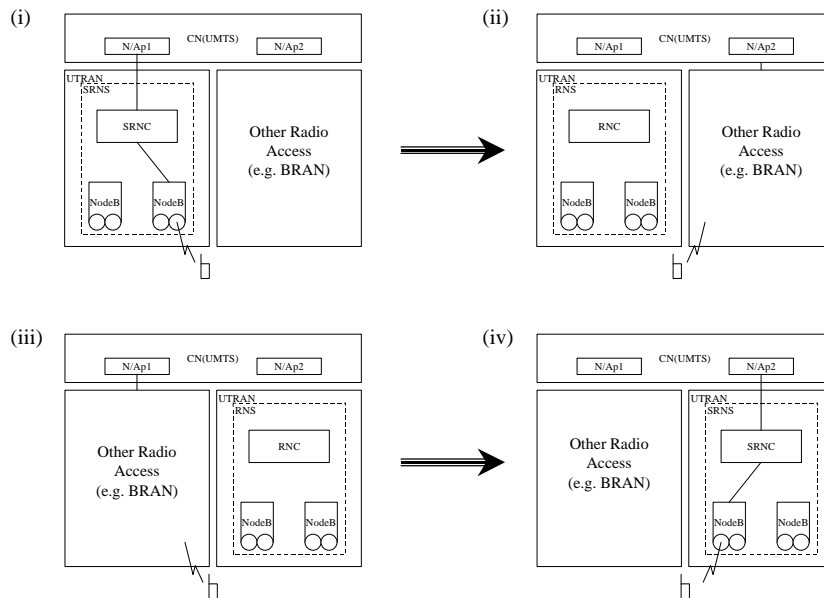

Inter UTRAN  
Different UTRAN Types

## 5.4 Inter CN (same UTRAN types)

This scenario shows the case where the handover is between two UTRANs that are connected to different UMTS core networks. An example of this would be inter-PLMN handover. This scenario will be supported by UTRAN as hard handover only and may involve a change of mode (FDD $\leftrightarrow$ TDD). Steps (i) & (ii) show the situation before and after.

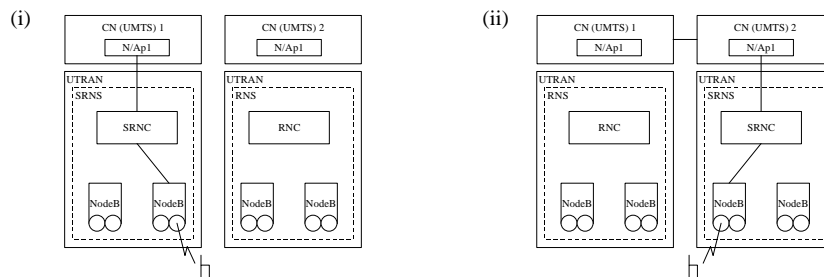

Inter CN  
Same UTRAN/CN Types

## 5.5 Inter CN (different UTRAN types)

This scenario is a combination of the previous two, with the handover between a UTRAN (connected to one UMTS CN) and another radio access (connected to a different UMTS CN; the interface is out of scope of this document). This scenario will not be supported in Release '99. Steps (i) & (ii) show handover from UTRAN. Steps (iii) & (iv) show handover to UTRAN.

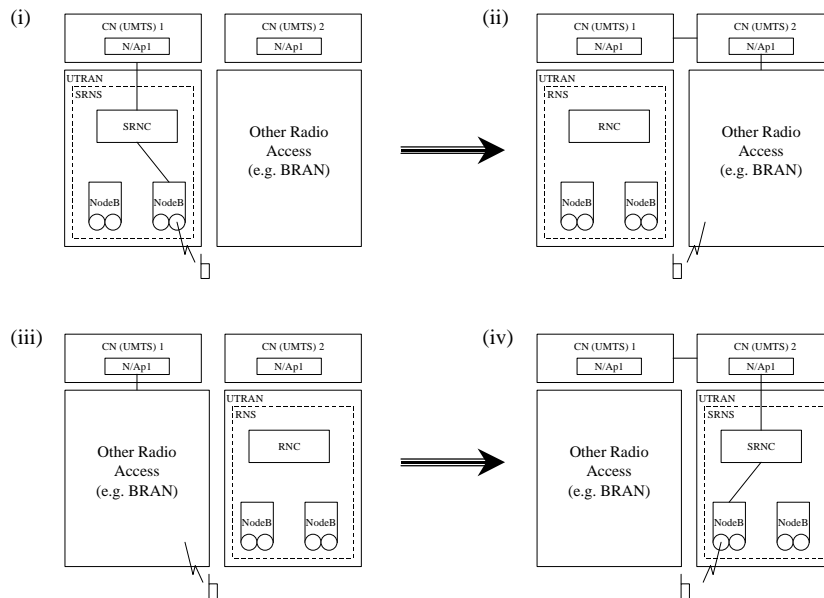

Inter CN  
Different URAN Types

## 5.6 Inter CN (different CN/URAN types)

This scenario shows the case of UMTS-GSM handover. More generally this scenario is for inter core network handover with different URAN types. It will be supported by UTRAN as a hard handover only. It is assumed that there will be no direct UTRAN-BSS interface. Steps (i) & (ii) show handover from UTRAN. Steps (iii) & (iv) show handover to UTRAN.

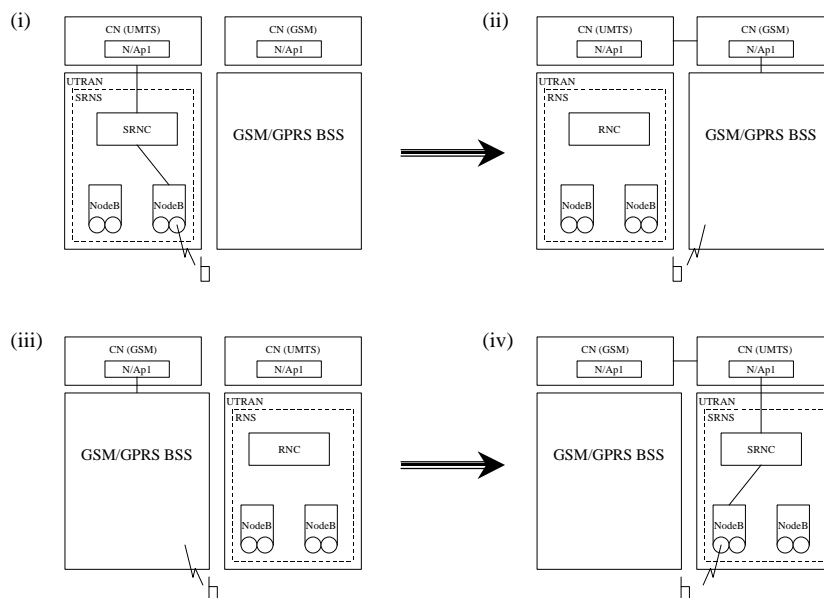

Inter CN  
Different CN/URAN Types

## 5.7 Intra CN (UTRAN-GSM/GPRS)

This scenario shows handover between UTRAN and a GSM BSS. This will be supported by the UTRAN as hard handover only. It is assumed that there will be no direct UTRAN-BSS interface, so handover between GSM BSS and

UTRAN is supported by switching in the core network. Steps (i) & (ii) show handover from UTRAN. Steps (iii) & (iv) show handover to UTRAN.

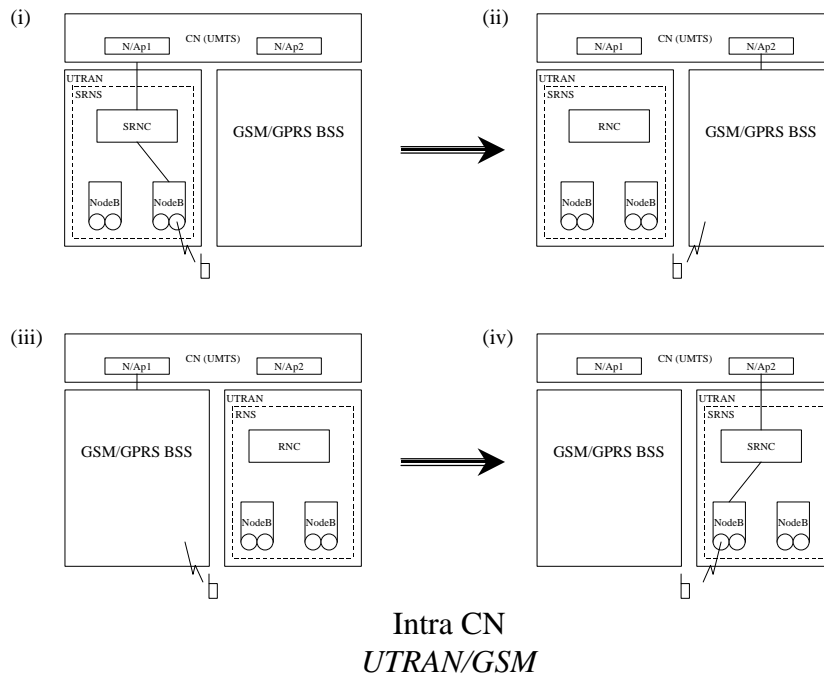

## 6 Applicability of the Scenarios

Handover between TDD and FDD mode (and vice versa) is a special case of the inter-cell, intra UTRAN or inter UTRAN hard handover scenarios shown above whenever the cells involved are of different modes (FDD or TDD). So, these mixed mode scenarios are already included in the relevant scenarios above.

## History

| <b>Document history</b>   |                         |   |
|---|-------------------------|---|
| v 0.0.1   | 1999-02                 | Initial Skeleton  |
| V0.0.2  | 1999-02                 | Skeleton Populated from ETSI document; change marks refer to changes agreed at the last meeting. There are no editorial changes to the ETSI text, other than re-organisation to fit the skeleton. |
| V0.0.3  | 1999-03                 | Inserted editor's proposed text for Scope chapter.  |
| V0.1.0  | 1999-04                 | Approved by WG3   |
| V2.0.0  | 1999-04                 | Endorsed by TSG-RAN   |
| V2.0.1  | 1999-05                 | Modified by WG3 to remove FFS's, scenario numbers, editor's notes and redundant text.   |
| <a href="#">V2.1.1</a>  | <a href="#">1999-06</a> | <a href="#">Note on SRNS Relocation limited cases added; clarification to section 5.3.</a>  |
| <a href="#">V2.2.0</a>  | <a href="#">1999-07</a> | <a href="#">Editorial Correction in RAN3 to remove remaining scenario number.</a>   |
| Editor for UMTS25.832 is:   |                         |   |
| Richard Townend<br>BT<br>Tel.: +44 1473 605 429<br>Fax : +44 1473 623 683<br>Email : <a href="mailto:richard.townend@bt.com">richard.townend@bt.com</a> |                         |   |
| This document is written in Microsoft Word version 7/97.  |                         |   |