

3G TR 25.880 V.2.0.0 (2002-02)

(Proposed Technical Report)

3rd Generation Partnership Project; Technical Specification Group Radio Access Network; Re-arrangement of Iu-b Transport Bearers (Rel 5)



The present document has been developed within the 3rd Generation Partnership Project (3GPP™) and may be further elaborated for the purposes of 3GPP.

The present document has not been subject to any approval process by the 3GPP Organisational Partners and shall not be implemented. This Specification is provided for future development work within 3GPP only. The Organisational Partners accept no liability for any use of this Specification. Specifications and reports for implementation of the 3GPP™ system should be obtained via the 3GPP Organisational Partners' Publications Offices.

Keywords

<keyword[, keyword]>

3GPP

Postal address

3GPP support office address

650 Route des Lucioles – Sophia Antipolis
Valbonne – FRANCE
Tel.: +33 4 92 94 42 00 Fax: +33 4 93 65 47 16

Internet

<http://www.3gpp.org>

Copyright Notification

No part may be reproduced except as authorized by written permission.
The copyright and the foregoing restriction extend to reproduction in all media.

© 2000, 3GPP Organizational Partners (ARIB, CWTS, ETSI, T1, TTA, TTC).
All rights reserved.

1. Contents

Foreword.....	4
1. Scope.....	4
2. References.....	5
3. Definitions, symbols and abbreviations	5
3.1. Definitions	5
3.2. Symbols	5
3.3. Abbreviations.....	5
4. Introduction.....	6
5. Requirements	7
6 Study Areas.....	7
6.1. Re-arrangement of Iub Transport Bearers	7
6.1.1. General	7
6.1.2. Possible uses for the Iub transport bearer re-arrangement process.....	7
6.1.3. New dedicated NBAP procedures.....	7
6.1.3.1 Re-arrangement of the signalling bearer for the given UE context	7
6.1.3.2 Re-arrangement of the transport bearer(s) for the given UE context.....	9
6.1.3.3 Re-arrangement of the signalling bearer and transport bearer(s) for the given UE context.....	9
6.1.3.4 Unsuccessful cases for the Transport Resource Re-arrangement Preparation procedure.....	11
6.1.3.5 Iub Transport bearer re-arrangement process completion for the given UE context.....	11
6.1.4. Re-using the RL Reconfiguration procedure.....	12
6.1.4.1 General	12
6.1.4.2 Re-arrangement of u-plane transport bearers.....	12
6.1.4.3 Re-arrangement of the signalling bearer.....	14
6.1.4.4 Re-arrangement of the signalling bearer and transport bearers for a given UE context	15
6.1.4.5 Open Items	15
6.1.5. Node-B Control port based approach.....	16
6.1.5.1 First step: Iub bearer re-arrangement Indication.....	16
6.1.5.2 Second step: Iub bearer re-arrangement	16
7. Agreements and associated contributions.....	19
8. Specification Impact and associated Change Requests.....	19
9. Project Plan	19
9.1. Schedule.....	19
9.2. Work Task Status.....	19
10. History	20

Foreword

This Technical Report has been produced by the 3rd Generation Partnership Project (3GPP).

The contents of the present document are subject to continuing work within the TSG and may change following formal TSG approval. Should the TSG modify the contents of the present document, it will be re-released by the TSG with an identifying change of release date and an increase in version number as follows:

Version x.y.z

where:

- x the first digit:
 - 2001. presented to TSG for information;
 - 2001. presented to TSG for approval;
 - 2001. or greater indicates TSG approved document under change control.
- y the second digit is incremented for all changes of substance, i.e. technical enhancements, corrections, updates, etc.
- z the third digit is incremented when editorial only changes have been incorporated in the document.

1. Scope

Based on [1], the objective of this work item is to introduce a new procedure in the NBAP to enable the Node B to indicate the request for switching the transport bearers and a Communication Control Port from one physical termination point to another. The purpose of the present document is to help the TSG RAN WG3 group to specify the changes to the existing NBAP specification.

It is intended to gather all information in order to trace the history and the status of the Work Task in RAN WG3. It is not intended to replace contributions and Change Requests, but only to list conclusions and make reference to agreed contributions and CRs. When solutions are sufficiently stable, the CRs can be issued.

It identifies the affected specifications with related Change Requests.

It also describes the schedule of the Work Task.

This document is a 'living' document, i.e. it is permanently updated and presented to all TSG-RAN meetings.

2. References

The following documents contain provisions which, through reference in this text, constitute provisions of the present document.

- References are either specific (identified by date of publication, edition number, version number, etc.) or non-specific.
- For a specific reference, subsequent revisions do not apply.
- For a non-specific reference, the latest version applies.

[1] RP-010465: Work Item Description for the Re-arrangement of Iub Transport Bearers.

[2] 3GPP TS 25.427: "UTRAN Iur/Iub Interface User Plane Protocol for DCH Data Stream".

[3] 3GPP TS 25.433: "UTRAN Iub Interface NBAP Signalling".

[4] 3GPP TS 25.430: "UTRAN Iub Interface: General Aspects and Principles".

3. Definitions, symbols and abbreviations

3.1. Definitions

For the purposes of the present document, the following terms and definitions apply.

Example: text used to clarify abstract rules by applying them literally.

3.2. Symbols

None.

3.3. Abbreviations

For the purposes of the present document, the following abbreviations apply:

AAL2	ATM Adaptation Layer type 2
CFN	Connection Frame Number
CRNC	Controlling Radio Network Controller
DCH	Dedicated Transport Channel
DSCH	Down-link Shared Channel
EP	Elementary Procedure
FACH	Forward Access Channel
NBAP	NodeB Application Part
O&M	Operation and Maintenance
RACH	Random Access Channel
RNC	Radio Network Controller
TLA	Transport Layer Address
UE	User Equipment
USCH	Up-link Shared Channel

4. Introduction

In the current NBAP specification there is no mechanism to change the D-NBAP link for the given Node B Communication Context and secondly there is no mechanism to switch the existing transport bearers from one physical termination point to another. Fixing of the transport resources may cause the transport resource fragmentation problem in the implementation where the physical resources are distributed. In the worst case the transport resource fragmentation may cause the rejection of some large capacity call. To solve this problem there is a need for a new procedure allowing the Node B to indicate the request for transport resource reallocation. This new procedure allows the use of distributed physical resources more efficiently by allowing a defragmentation of the resources and it may be used also due the O&M reasons.

5. Requirements

The following requirements are identified:

It shall be possible to the Node B to initiate the following actions:

1. Re-arrange the signalling bearer for the given UE context.
2. Re-arrange the transport bearer(s) for the given UE context.
3. Re-arrange the signalling bearer and transport bearer(s) for the given UE context.

In addition, it should be possible for the CRNC as well to initiate these actions e.g. for O&M purposes.

6 Study Areas

6.1. Re-arrangement of Iub Transport Bearers

6.1.1. General

Any new functionality introduced in Release 5 should be introduced with the least possible impact to the R99/R4 specifications.

6.1.2. Possible uses for the Iub transport bearer re-arrangement process

Transport resource fragmentation means, that the transport resource pool may be physically distributed i.e. the total amount of transport resources are divided in n segments. Thus there may appear the situation, where for an incoming RL Setup/modification, there is enough transport resources in the whole transport resource pool to satisfy the requirements of the request, but due to the transport resource fragmentation, there is not enough transport resources in any segments of the transport resource pool to actually successfully process the request. To prevent the rejection of the incoming RL setup/modification the Iub Transport bearer re-arrangement process may be used to free transport resources on a segment for a Radio Link(s) to be established/ modified by switching the existing transport bearers for a given UE context from one physical termination point to another.

The Iub Transport bearer re-arrangement process may also be used to allow balancing the transport resources between the segments of the Node B transport resource pool. This process may be seen as a process managing the Node B internal transport resources.

6.1.3. New dedicated NBAP procedures

6.1.3.1 Re-arrangement of the signalling bearer for the given UE context

In the current NBAP specification the signalling bearer between the RNC and the Node B for the control of Node B Communication Context (UE context) is selected by the Node B at the creation of the Node B Communication Context and there is no way to change the Communication Control Port once it is selected.

In the new proposed functionality 'Re-arrangement of the signalling bearer for the given UE context' it shall be possible to reselect the signalling bearer between the RNC and Node B for the control of Node B Communication Context (UE context) during the 'active call' without losing data or radio link synchronisation. Due to this requirement, proposed new signalling bearer re-arrangement functionality shall be synchronously executed between the CRNC and the Node B. To fulfil this requirement it is proposed to split 'Re-arrangement of the signalling bearer for the given UE context' functionality for two elementary procedures.

1. Transport Resource Re-arrangement Preparation procedure (Class 1 EP); and

2. Signalling Bearer Re-arrangement Complete procedure (Class 2 EP).

Transport Resource Re-arrangement Preparation procedure is initiated by the Node B using dedicated NBAP procedure. In the procedure initiation message the following information shall be provided by the Node B to the CRNC:

- The context identifier of the target Node B Communication Context- *CRNC Communication Context ID IE*;
- Transport Bearer Rearrangement type indicating, that the signalling bearer for the Node B Communication Context is prepared to be rearranged; and
- New Communication Control Port for the Node B Communication Context - *Communication Control Port ID IE*.

Upon the reception of the Transport Resource Re-arrangement Preparation procedure initiation message the CRNC may either accept or reject the preparation procedure.

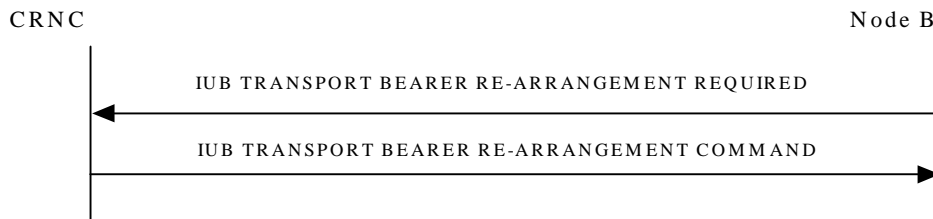

Figure 1: Transport Resource Re-arrangement Preparation procedure, Successful Operation

If the CRNC accepts the Transport Resource Re-arrangement Preparation procedure for the identified Node B Communication Context, it shall respond with the procedure acknowledge message (Command). The message shall identify the target context with the *Node B Communication Context ID IE*. Once the CRNC has accepted the preparation procedure and it is completed successfully, it shall not initiate any procedure using the current Communication Control Port for the considered Node B Communication Context, until the Signalling Bearer Re-arrangement is completed..

If the preparation procedure is accepted by the CRNC, the Node B shall then proceed to switch the identified Node B Communication Context, with context attributes [4], to a new Communication Control Port. During the switching process the Node B shall not initiate any procedure using the current Communication Control Port for the considered Node B Communication Context, until the Signalling Bearer Re-arrangement is completed.

When the considered Node B Communication Context is switched to a new Communication Control Port, the Node B shall initiate the Signalling Bearer Re-arrangement Complete procedure towards the CRNC using the newly allocated signalling bearer. This procedure is used to inform the CRNC, that the signalling bearer for considered Node B Communication Context is successfully switched in the Node B. The newly allocated signalling bearer shall then be used both by the CRNC and the Node B for any new procedure for the considered Node B Communication Context.



Figure 2: Signalling Bearer Rearrangement Complete procedure

6.1.3.2 Re-arrangement of the transport bearer(s) for the given UE context

In the current NBAP specification there exist a mechanism to replace the transport bearer for a dedicated transport channel (DCH & DSCH). The procedure is initiated by the SRNC with the Synchronized/Unsynchronized Radio Link Reconfiguration by setting the *Transport Bearer Request Indicator IE* to value 'Bearer Requested' for the transport channel to be modified. When the new bearer is required for the transport channel, the new transport bearer is established and the old transport bearer is replaced with the new one synchronously or asynchronously as specified in the [2].

In the proposed new functionality 'Re-arrangement of the transport bearer(s) for the given UE context' the transport bearer rearrangement (replacement) for the given UE context is started by the Node B. The Node B initiates the Transport resource re-arrangement preparation procedure using a dedicated NBAP procedure. In the procedure initiation message the following information shall be provided by the Node B to the CRNC:

- The context identifier of the target Node B Communication Context- *CRNC Communication Context ID IE*;
- Transport Bearer Rearrangement type, indicating, that the transport bearer(s) for the Node B communication Context is/are prepared to be rearranged; and
- New *AAL2 Binding ID* and *TLA* for every transport channel prepared to be re-arranged

Upon the reception of the Transport resource re-arrangement preparation procedure initiation message the CRNC may either accept or reject the preparation procedure.

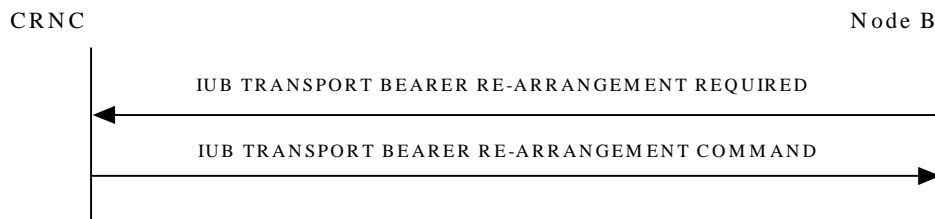

Figure 3: Transport Resource Re-arrangement Preparation procedure, Successful Operation

If the CRNC accepts the Transport Resource Re-arrangement Preparation procedure, it shall respond with the procedure acknowledge message (Command) and identify the target context with the *Node B Communication Context ID IE*. The CRNC may include the *CFN IE* in the procedure acknowledge message to indicate that the new transport bearer shall take place at the indicated CFN. After sending the procedure acknowledge message the CRNC shall then proceed for establishing a new *AAL2* connection for the transport channel to be re-arranged.

The transport bearer is then replaced synchronously or asynchronously, depending on the presence of the *CFN* in the Transport Resource Re-arrangement Preparation procedure acknowledge message, as specified in the [2]. Finally the old transport bearer is released.

6.1.3.3 Re-arrangement of the signalling bearer and transport bearer(s) for the given UE context

'Re-arrangement of the signalling bearer and transport bearer(s) for the given UE context' functionality is the combination of the both proposed functionality presented above. This functionality shall also consist of

1. The Transport Resource Re-arrangement Preparation procedure, to prepare the rearrangement of both the signalling bearer and the transport bearer(s) for given Node B Communication Context; and
2. The Signalling Bearer Re-arrangement Complete procedure to inform the CRNC, that the signalling bearer for the given Node B Communication Context is successfully switched in the Node B.

In the Transport Resource Re-arrangement Preparation procedure initiation message the following information shall be provided by the Node B to the CRNC:

- The context identifier of target Node B Communication Context- *CRNC Communication Context ID IE*;
- Transport Bearer Rearrangement type, indicating, that both the signalling bearer and transport bearer(s) for the Node B Communication Context are prepared to be rearranged;
- New Communication Control Port for the target Node B Communication Context - *Communication Control Port ID IE*;and
- New *AAL2 Binding ID* and *TLA* for every transport channel prepared to be re-arranged.

Upon the reception of the Transport resource re-arrangement preparation procedure initiation message, the CRNC may either accept or reject the whole preparation procedure. It is not possible to accept only the part of preparation procedure e.g. so that the signalling bearer rearrangement preparation is accepted and the transport bearer rearrangement preparation is rejected.

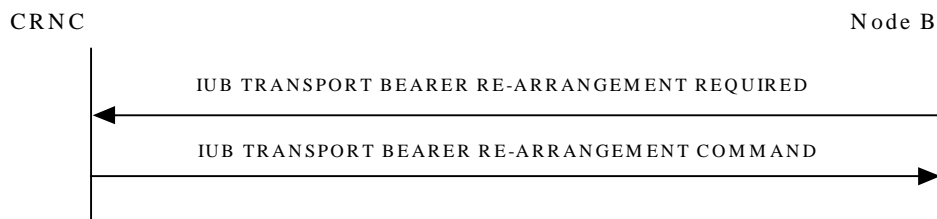

Figure 4: Transport Resource Re-arrangement Preparation procedure, Successful Operation

If the CRNC accepts the Transport Resource Re-arrangement Preparation procedure, it shall respond with the procedure acknowledge message (Command), and identify the target context with the *Node B Communication Context ID IE*. The signalling bearer is then switched to a new Communication Control Port as described in chapter Re-arrangement of the signalling bearer for the given UE context and the transport bearer(s) for the transport channels to be re-arranged are replaced as described in chapter Re-arrangement of the transport bearer(s) for the given UE context.



Figure 5: Signalling Bearer Rearrangement Complete procedure

6.1.3.4 Unsuccessful cases for the Transport Resource Re-arrangement Preparation procedure

The CRNC may reject the Transport Resource Re-arrangement Preparation procedure by sending negative acknowledge to the Node B.

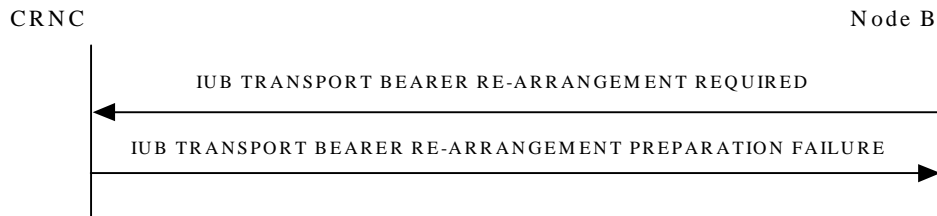

Figure 6: Transport Resource Re-arrangement Preparation procedure, Unsuccessful Operation

At least following reasons can be identified for the preparation procedure rejection:

1. Transport Bearer Re-arrangement type not supported, and
2. Transport Bearer Re-arrangement not allowed

First cause value shall be used to inform that requested functionality is not supported by the CRNC. The latter cause value is used to inform that there exist the required functionality in the CRNC, but the CRNC rejects the request due some emergency signalling requirements for the concerned Node B Communication Context.

6.1.3.5 Iub Transport bearer re-arrangement process completion for the given UE context

As pointed out in the chapter Possible uses for the Iub transport bearer re-arrangement process this procedure may be triggered by incoming request for RL Setup/Modification or allow balancing the transport resources between the segments of the Node B transport resource pool. The latter alternative is the constant process running based on Node B internal algorithm managing the Node B internal transport resources

If the Iub transport bearer re-arrangement process was triggered due to incoming request, the request need to be put the queue to wait that needed resources are freed in any segment of the Node B transport resource pool.

If the Node B is able to complete the Iub transport bearer re-arrangement process to free resources, the incoming request shall be completed as specified for the successfully case of operation.

If the Node B is not able to complete the Iub transport bearer re-arrangement process to free resources, the incoming request shall be completed as specified for the unsuccessfully case of operation.

6.1.4. Re-using the RL Reconfiguration procedure

6.1.4.1 General

Re-arrangement of transport bearers which are associated to a Traffic Termination Point (in contrast to transport bearers for common transport channels like RACH/FACH) basically includes these three cases:

- 1) Re-arrangement of transport bearers for u-plane data ports (DCH and/or DSCH/USCH) only
- 2) Re-arrangement of signalling transport bearers only
- 3) Re-arrangement of both u-plane and signalling transport bearers

It is desirable to have similar procedures for these three cases, and also to re-use existing NBAP procedures as far as possible. It is therefore considered to use the Synchronised or Unsynchronised Radio Link Reconfiguration procedures with a suitable extension for these TB Rearrangement purposes. However, in addition to these existing procedures, one new class 2 EP "Iub Bearer Re-Arrangement Indication" seems to be required.

Following this approach, the **following extensions** of the existing NBAP protocol would be required.

- 1) A **new class 2 procedure** "Iub Bearer Re-Arrangement Indication" should be introduced which allows the Node B to indicate that a re-arrangement of the signalling bearer or the data transport bearers or both is required. So this procedure should include an optional *Signalling Bearer Request Indicator* IE and an optional *Transport Bearer Request Indicator* IE.
- 2) The RADIO LINK RECONFIGURATION PREPARE message and the RADIO LINK RECONFIGURATION REQUEST message should be extended to include an **optional Signalling Bearer Request Indicator IE**.
- 3) The RADIO LINK RECONFIGURATION READY message and the RADIO LINK RECONFIGURATION RESPONSE message should be extended to include an **optional Communication Control Port ID IE**.

In addition, the procedure text to be added should specify that whenever the Radio Link Reconfiguration procedure (synchronised or unsynchronised) includes a Signalling Bearer change, this change shall – provided the CRNC and the Node B have agreed on that change - **become effective after the last message of the successfully executed synchronised or unsynchronised Radio Link Reconfiguration procedure**, respectively, i.e.

- in case of the Synchronised Radio Link Reconfiguration procedure, the new Communication Control Port shall be used once the Node B has received the RADIO LINK RECONFIGURATION COMMIT message (via the old Communication Control Port);
- in case of the Unsynchronised Radio Link Reconfiguration procedure, the new Communication Control Port shall be used once the Node B has sent the RADIO LINK RECONFIGURATION RESPONSE message (via the old Communication Control Port)

So if in case of the Synchronised Radio Link Reconfiguration procedure, the CRNC would decide to cancel the procedure by sending a RADIO LINK RECONFIGURATION CANCEL message, neither u-plane nor c-plane Transport Bearers are re-arranged. (So there is no issue any more about this case.)

More details are explained below.

6.1.4.2 Re-arrangement of u-plane transport bearers

If only the u-plane transport bearer(s) for a given UE context are required to be re-arranged by the Node B, the CRNC may initiate the Synchronised/Unsynchronised Radio Link Reconfiguration for every transport channel that is required to be re-arranged. This is existing functionality in the NBAP specification and thus no modifications are needed for the NBAP for the reconfiguration procedure itself.

However in addition to the RL Reconfiguration procedure itself which is triggered by the CRNC, a new procedure is needed to allow the Node B to request this Transport Bearer Re-arrangement. This could be the "Iub Bearer Re-arrangement Indication" procedure which should be a class 2 EP:

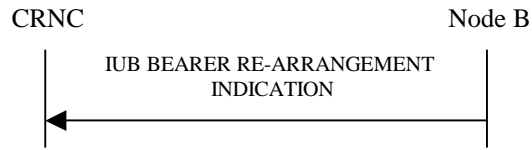

Figure 7: Iub Bearer Re-arrangement Indication procedure

In this message, the Node B shall indicate the requested kind of Transport Bearer Rearrangement. In case of u-plane Transport Bearer re-arrangement only, the Node B shall include the *Transport Bearer Request Indicator* IE with value 'Bearer Requested'.

The CRNC should respond by performing the suitable RL Reconfiguration procedure, e.g. the synchronised RL Reconfiguration which consists of the respective Preparation and Commit procedures:

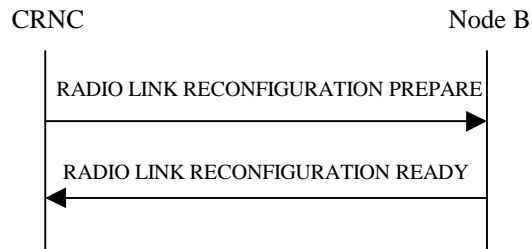

Figure 8: Synchronised Radio Link Reconfiguration Preparation procedure, Successful Operation

In the RL Reconfiguration Prepare message, the CRNC should use the Transport Bearer Request Indicator IE to indicate the request for new Transport Bearers for the Transport Channels to be rearranged. In the RL Reconfiguration Ready, the Node B includes the TLA and Binding Id for these Transport Bearers.

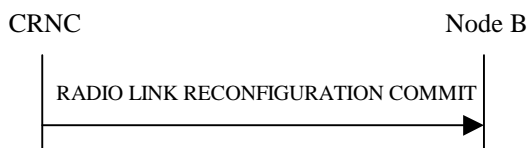

Figure 9: Synchronised Radio Link Reconfiguration Commit procedure, Successful Operation

With this procedure, the TB Rearrangement would become effective.

6.1.4.3 Re-arrangement of the signalling bearer

If the signalling bearer which carries the Dedicated NBAP messages for a UE Communication Context shall be re-arranged, in principle the same sequence of procedures might be applicable. However, for this purpose, the Synchronised RL Reconfiguration Prepare and Ready messages must be extended to be applicable for c-plane transport bearer reconfiguration. RL Reconfiguration procedure serves for moving the dedicated NBAP messages from a “Source Communication Control Port” to a “Target Communication Control Port”.

As with the u-plane rearrangement, the Node B would indicate the request for TB rearrangement by means of the Iub Bearer Re-arrangement Indication (class 2 EP) procedure.

In this message, the Node B shall indicate the requested kind of Transport Bearer Rearrangement by including the optional *Signalling Bearer Request Indicator* IE with value 'Bearer Requested'.

Upon receipt of the IUB BEARER RE-ARRANGEMENT INDICATION message, the CRNC should perform the RL Reconfiguration procedure in order to move the respective Dedicated NBAP connection from the old Source to the new Target Communication Control Port of the Node B. This seems to be feasible with some modifications to the existing Synchronised Radio Link Reconfiguration procedures. It is proposed to have the optional *Signalling Bearer Request Indicator* IE in the reconfiguration prepare message. When the signalling bearer is required to be re-arranged i.e. the physical termination point of the signalling bearer (D-NBAP link) for the given UE context is required to be switched, the *Signalling Bearer Request Indicator* IE flag is set to value 'Bearer Requested'.

When the *Signalling Bearer Request Indicator* IE is set to 'Bearer Requested', the Node B shall signal the Target *Communication Control Port ID* to the CRNC in the RL reconfiguration ready message.

RL Reconfiguration procedure for re-arrangement of signaling bearer thus consists of the following messages (if the Synchronised RL Reconfiguration procedure is chosen):

1. Node B sends to CRNC the IUB BEARER REARRANGEMENT INDICATION message with *Signalling Bearer Request Indicator* IE set to 'Bearer Requested'.
2. The CRNC should response with RADIO LINK RECONFIGURATION PREPARE message in which again the *Signalling Bearer Request Indicator* IE is set to value 'Bearer Requested' (Message is sent through the Source Communication Control Port to Node B).
3. If it is possible, Node B should response with the RADIO LINK RECONFIGURATION READY message – still via the Source Communication Control Port.
4. The CRNC makes commitment of Transport Bearer Rearrangement by sending the RADIO LINK RECONFIGURATION COMMIT message –still via the Source Communication Control Port. The CRNC after sending this message shall use the Target Communication Control Port for any dedicated NBAP message for that Communication Context. The Node B, after having received that message, shall also use the Target Communication Control Port for the signalling for the respective Communication Context.

Error cases:

- 1) If the Node B requests a Communication Control Port change and the CRNC is **not willing** or able to perform it (e.g. “function not supported”), then the CRNC should not include the *Signalling Bearer Request Indicator*

IE in the RADIO LINK RECONFIGURATION PREPARE (or REQUEST, resp.) message. In this case, the Node B shall reject the procedure with RADIO LINK RECONFIGURATION FAILURE – unless the Node B decides to continue the procedure without Signalling Bearer Re-arrangement.

- 2) If the CRNC requests a Communication Control Port change and the **Node B is not willing** or able to perform it (e.g. “function not supported”), then the Node B shall reject the procedure with RADIO LINK RECONFIGURATION FAILURE.
- 3) If the Node B is in the Reconfiguration Prepared state and the CRNC sends RADIO LINK RECONFIGURATION CANCEL, the old Transport Bearers are used unchanged.

Procedure Parallelism:

The Radio Link Reconfiguration Preparation procedure and the Unsynchronised Radio Link Reconfiguration procedure proposed here for Transport Bearer re-arrangement are performed via the Dedicated NBAP signalling bearer. Therefore, based on the existing rule for procedure parallelism, no other Dedicated NBAP procedure for the concerned Communication Context can take place during the critical parts of the Transport Bearer re-arrangement. This reduces the risk of collision between the Transport Bearer rearrangement and any other NBAP procedure, without the need to define any additional rules for procedure parallelism.

6.1.4.4 Re-arrangement of the signalling bearer and transport bearers for a given UE context

Again, the Node B shall indicate the request for this combined c-plane and u-plane Transport Bearer re-arrangement procedure by means of the Iub Bearer Re-arrangement Initiation (class 2 EP) procedure.

If both the signalling bearer and the transport bearer(s) for the given UE context are requested to be re-arranged by the Node B, the CRNC can initiate the Synchronized (or Unsynchronized) Radio Link Reconfiguration for the signalling bearer and for every transport channel that is required to be re-arranged. The CRNC shall set the *Signalling Bearer Request Indicator* IE and the existing *Transport Bearer Request Indicator* IE to value 'Bearer Requested' for the signalling bearer and all the transport bearers required to be re-arranged

When the new signalling bearer and transport bearer(s) for the UE context are required, the Node B shall signal the new *Communication Control Port ID* for the UE Context (Node B Communication Context) and AAL2 Binding ID and TLA for every transport channel that is required to be re-arranged to the CRNC in the RL reconfiguration ready/response message. The CRNC shall then proceed for establishing the new transport bearer and the switching to the new transport bearer is done as specified in [3] and [2].

RL Reconfiguration procedure for re-arrangement of signaling bearer and transport bearers thus consist of two parts - first one is actually re-arrangement of the signaling bearer which could be prepared as it is described in chapter 6.2.3, points 1 to 4, only in the message TRANSPORT BEARER REARRANGEMENT INITIATION should be added *Transport Bearer Request Indicator* IE with value 'Bearer Requested' for all the transport bearers required to be re-arranged. Second part of the procedure is done as specified in 6.2.2.

6.1.4.5 Open Items

The previously identified open item for the proposed solution of Bearers Rearrangement in Control Plane re-using the RL Reconfiguration procedure has been closed by redefining the timing when the Node B and the CRNC switch to the new Communication Control Port.

6.1.5. Node-B Control port based approach

6.1.5.1 First step: Iub bearer re-arrangement Indication

The "Iub bearer re-arrangement indication" Class 2 procedure can be defined as follows:

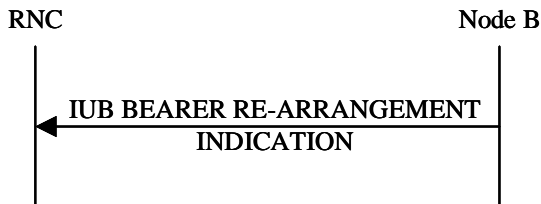

Figure 10: Iub Bearer Re-arrangement Indication procedure

There are 2 different ways of handling this:

- We can use this new message to simply indicate the need to re-arrange the considered Signalling Bearer and/or Transport Bearer(s).
- We can take advantage of this new message to provide the CRNC with additional information thus speeding up the process of this re-arrangement. the *Binding ID* and the *Transport Layer Address* IEs for the new Transport Bearer(s) will be included in the new message.

For Signalling Bearer re-arrangement:

The IUB RE-ARRANGEMENT INDICATION message indicates the *CRNC Communication Context ID* IE corresponding to the Node B Communication Context to be moved.

This message could also contain the *Communication Control Port ID* IE indicating the new Signalling Bearer to be used for the considered Node B Communication Context (see second proposition above).

For Data Transport Bearer re-arrangement:

The IUB BEARER RE-ARRANGEMENT INDICATION message indicates the *CRNC Communication Context ID* IE corresponding to the Node B Communication Context which has associated data transport bearers needing re-arrangement.

Furthermore, the IUB BEARER RE-ARRANGEMENT INDICATION message indicates the transport channels for which a transport bearer re-arrangement is needed.

This message could also contain the *Binding ID* and the *Transport Layer Address* IEs for the transport channels to be switched to a new Transport Bearer(s) (see second proposition above).

Note: The second possibility could prove to be a problem. The Node B has to configure the re-arrangement in advance: for transport bearer re-arrangement, this would certainly mean reservation of resources on the new resource segment. However, it is always possible that the CRNC does not initiate the re-arrangement (feature not supported,...). In some implementations, this would result in having an internal timer (waiting for the arrival of the IUB BEARER RE-ARRANGEMENT REQUEST message) to allow the release of these reserved resources. The situation becomes unstable if the CRNC has decided to postpone the re-arrangement, then requests it and in the meantime the timer in the Node B has elapsed. In this case, the Failure message must be used and the Node B shall indicate once again its need.

Open Issue: Is there a need to indicate whether the re-arrangement for all the Data transport bearers shall be synchronous or not?

6.1.5.2 Second step: Iub bearer re-arrangement

There are two ways of handling the transport bearer re-arrangement itself:

- We can define a new Class 1 procedure dedicated to the purpose of Iub transport bearers re-arrangement.

- We can rely on the existing reconfiguration procedures (either Synchronised or Unsynchronised) and enhance these procedures to support this new feature.

In the "General Mechanism" section above, it was shown that it would be preferable to define a new Class 1 procedure which would be a Common procedure. This new procedure can be defined as follows:

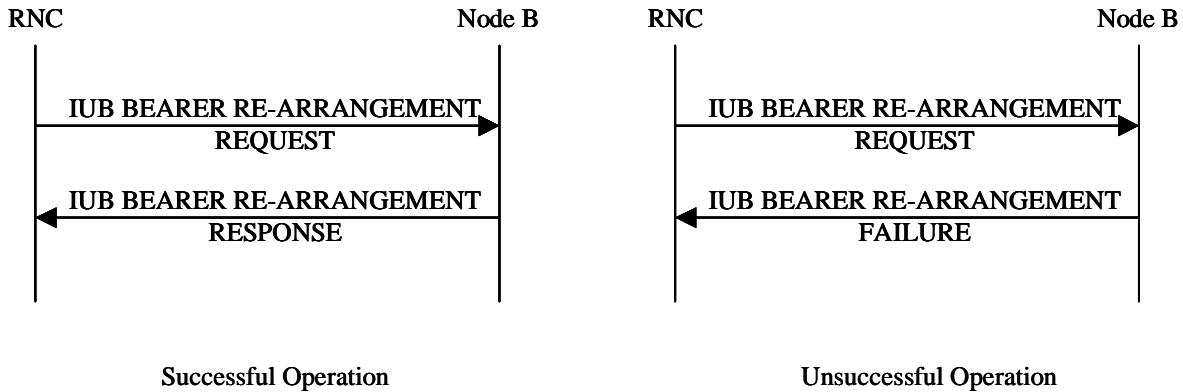

Figure 11: Iub Bearer Rearrangement, Successful operation

Figure 12: Iub Bearer Rearrangement, Unsuccessful operation

Data Transport Bearer re-arrangement:

The Transport Bearer replacement procedure defined in details in TS 25.427 can be used for this purpose. It could be triggered by the new IUB BEARER RE-ARRANGEMENT REQUEST message. This message could optionally contain a CFN at which the re-arrangement would be performed. The User Plane behaviour would then be similar to the one for the Transport Bearer Replacement initiated by a Synchronised Radio Link Reconfiguration (if the CFN is present) or by an Unsynchronised Radio Link Reconfiguration (if the CFN is not present).

Signalling Bearer re-arrangement:

A similar definition is needed. It is proposed to have a behaviour similar to the one defined in the Radio Link Setup procedure. The following procedure is proposed:

Successful Operation:

- At reception of the IUB BEARER RE-ARRANGEMENT REQUEST message, the Node B determines the new Communication Control Port to be used for the considered Node B Communication Context.
- The Node B, then, sends back the IUB BEARER RE-ARRANGEMENT RESPONSE message to the CRNC with the *Communication Control Port ID* IE indicating the ID of the new Communication Control Port to be used for the considered Node B Communication Context. After sending this message, the Node B shall use the new Communication Control Port for the considered Node B Communication Context.
- At reception of the message, the CRNC should use the new Communication Control Port for all the dedicated NBAP procedures for the considered Node B Communication Context.

Unsuccessful Operation:

- The Node B sends back the IUB BEARER RE-ARRANGEMENT FAILURE message to the CRNC. After sending this message, the Node B shall continue using the old Communication Control Port for the considered Node B Communication Context.

The behaviour of the CRNC should be the following:

- Since the Iub Bearer Re-Arrangement is a Common procedure and the procedures using the Communication Control Port are dedicated procedures, none of the existing rules on procedure parallelism apply. Thus, it is possible for the CRNC to use the old Communication Control Port for dedicated procedures for a Node B Communication Context for which it has initiated an Iub Signalling Bearer Re-Arrangement. Such an untimely use of the "old" Communication Control Port for the considered Node B Communication Context should be avoided as much as possible. For this, once the IUB BEARER RE-ARRANGEMENT REQUEST message is sent by the CRNC, it would be better for the CRNC not to initiate any dedicated NBAP procedure for the Node B

Communication Context. This would, for instance, allow to avoid the loss of messages due to messages crossing each other on the interface. In fact, if an NBAP dedicated message for the concerned Node B Communication Context sent by the CRNC on the old Communication Control Port "crosses" the IUB RE-ARRANGEMENT RESPONSE message over the Iub, then this message will be discarded by the Node B (as it shall use only the "new" Communication Control Port after sending the IUB RE-ARRANGEMENT RESPONSE message). It will thus probably be considered as "lost" by the RNC after a timer has elapsed.

- At reception of the IUB BEARER RE-ARRANGEMENT RESPONSE message, the CRNC should use the new Communication Control Port for all the dedicated NBAP procedures for the considered Node B Communication Context.
- At reception of the IUB BEARER RE-ARRANGEMENT FAILURE message, the CRNC should continue using the old Communication Control Port for all the dedicated NBAP procedures for the considered Node B Communication Context.

However, in order to respect our specification principles, no behaviour should be specified for the CRNC.

One way of avoiding "crossing messages" problems as much as possible is to forbid the use of the old Communication Control Port for a Node B once it has received an IUB BEARER RE-ARRANGEMENT REQUEST message for the Signalling Bearer and this until it has completed the procedure (i.e. it has sent back an IUB BEARER RE-ARRANGEMENT RESPONSE/FAILURE message).

Note: There is no way to fully insure that if the Node B sends an NBAP message (e.g. RADIO LINK FAILURE/RESTORE INDICATION) on the new Communication Control Port just after sending an IUB RE-ARRANGEMENT RESPONSE, the CRNC will receive it after the IUB RE-ARRANGEMENT RESPONSE message indicating the new Communication Control Port ID. The requirement in §6 of TS 25.433 does not apply since the messages are sent on different bearers. However, since this is already the case for the Radio Link Setup procedure and subsequent messages (e.g. RADIO LINK RESTORE INDICATION), this is not considered an issue.

7. Agreements and associated contributions

It is agreed that the solution described in subclause 6.1.4. Re-using the RL Reconfiguration procedure, is the most feasible and the one that best fulfils the requirements presented in subclause 5.

Additionally it was agreed to add a new cause value "Bearer Re-arrangement needed" in RADIO LINK RECONFIGURATION FAILURE message, for Node B to inform the CRNC about need for bearer rearrangement for the completion of the requested RL Reconfiguration

8. Specification Impact and associated Change Requests

The introduction of Re-arrangement of Iub Transport Bearers would mainly affect to TS25.433. In addition it shall be clarified in TS25.430 'UTRAN Iub interface: general aspects and principles', that the Communication Control Port for the control of Node B Communication context is re-selected when the signalling bearer for the Node B Communication is rearranged

Table 1: Affected Release 5 specifications and the related Change Requests

3G TS	CR	Title	Remarks
3G TS 25.433	588r1	Re-arrangement of Iub Transport Bearers	
3G TS 25.430	028	Communication Control Port re-selection	

9. Project Plan

9.1. Schedule

Date	Meeting	Scope	[expected] Input	[expected]Output

9.2. Work Task Status

	Planned Date	Milestone	Status
1.			
2.			

10. History

Document history		
Date	Version	Comment
2001-05	v. 0.0.1	First Proposal
2001-05	v. 0.0.2	Second Proposal, TR updated according to received comments in RAN WG3#21 meeting.
2001-08	v. 0.1.0	Version agreed at RAN WG3#21
2001-10	v.0.1.1	Rapporteurs proposal reflecting agreements made during RAN3#23
2001-11	v.0.2.0	Version agreed at TSG RAN3 #24
2001-11	v.0.2.1	Rapporteurs proposal reflecting agreements made during RAN3#24
2001-11	v.0.3.0	Version agreed at TSG RAN3 #25
2001-11	v.0.3.1	Rapporteurs proposal reflecting agreements made during RAN3#25
2001-02	v.0.4.0	Version agreed at TSG RAN3 #26
2001-02	v.0.4.1	Rapporteurs proposal reflecting agreements made during RAN3#26
2001-02	v.0.4.2	Rapporteurs proposal for restructuring the study areas section
2001-02	v.0.5.0	Version agreed at TSG RAN3 #27
2001-02	v.0.5.1	Rapporteurs proposal of version 0.5.1 to be raised as version 1.0.0
2001-02	v.1.0.0	Version agreed at TSG RAN3 #27
2001-02	v.2.0.0	Version e-mail approved by RAN WG3
Editor for 3G TR 25.880 is Jari Hautala, Nokia :		
Tel. : +358 7 180 55087 Fax : +358 7 180 55115 Email : jari.p.hautala@nokia.com		
This document is written in Microsoft Word version.		